

GENTIS

LIVING





GENTIS LIVING

Extravagant combinations and expressive solo units

From a pure look to an extravagant mixture of materials: the Gentis living room range is based on modest forms and combines them with natural wood and high-quality leather. This mixture results in a range for lovers of design who require intelligent ways of combining the various units.

System units of matt or high-gloss lacquer in grey and white form the basis of Gentis. They can be employed flexibly as sideboards, lowboards, cabinets or wall units and provide a host of living room combinations. The sideboards and lowboards are particularly expressive in their form. They include rounded corner sections which achieve a particularly soft and harmonious effect; the single units are highlighted and appear to hover by the wall thanks to a functional frame with optional LED lamps. Alternatively, the lowboards and sideboards can also be fitted with a high-gloss chrome design sub-structure so that they determine the design of the living room in the form of stand-alone solitary units and elegant room dividers.

Contents

	Page
Range introduction, lists of versions, concept and possible arrangements	2-5
Suggested combinations	6-9
2 and 3 Raster (room divider) lowboards	10-23
Media accessories for lowboards	24-25
3 and 4 Raster (room divider) sideboards	26-31
8 Raster highboard	32
8 and 12 Raster cabinets	33-34
6 Raster wall units	35
Accent units	36-38
Accessories for units	39-40
Dining rooms, coffee tables	41
General information:	
Cable apertures	42
Special-sized products, special articles	43
Switch options for lamps	44-45
Important notes: quality of walls / assembly instruction	46

Leather and knotted wood versions create special accents

The accent units in Gentis were created to provide exclusive highlights. In high-quality leather and wood with a natural look, they provide an exciting contrast to the more modest lacquer system units and can be planned as shelf, floor or wall units. Manufactured in wood or leather, they underline the innovative strength and high level of craftsmanship typical of hülsta furniture. In the genuine leather units, the base units are provided with light upholstery in the form of leather covers from the hülsta collection. These units not only look most exclusive, their fine surfaces are also pleasant to touch. Wood versions in a knotted look are available as accent units. The rough character of the wood with its burls and knots becomes quite an extravagant eyecatcher and forms some exciting contrasts to the lacquer units. The outer glass sides of the (wall) cabinets in bronzed glass set the stage for another highlight - the rear wall in roughly brushed knotted natural oak. So the result is a used look together with true perfection.

Lists of versions

Model no.	Carcase and front	Price group	Model no.	Accent units: Carcase and front	Price group	Model no.	Cabinet compartment rear wall, 6 Raster wall units
648	Pure white lacquer	I	648	Pure white lacquer	I	648	Pure white lacquer
045	White lacquer	I	045	White lacquer	I	045	White lacquer
046	Grey lacquer	I	046	Grey lacquer	I	046	Grey lacquer
663	Silk grey lacquer	I	663	Silk grey lacquer	II	663	Silk grey lacquer
862	High-gloss pure white lacquer	II	862	High-gloss pure white lacquer	II	862	High-gloss pure white lacquer
860	High-gloss white lacquer	II	860	High-gloss white lacquer	II	860	High-gloss white lacquer
861	High-gloss grey lacquer	II	861	High-gloss grey lacquer	II	861	High-gloss grey lacquer
614	High-gloss silk grey lacquer	II	614	High-gloss silk grey lacquer	II	614	High-gloss silk grey lacquer
			051	Natural oak	II	051	Natural oak
			053	Core walnut	II	053	Core walnut
			693	Knotted oak	III	693	Knotted oak
			697	Knotted oak anthracite	III	697	Knotted oak anthracite
			694	Knotted core walnut	III	694	Knotted core walnut
			51..	Nappa leather (51..)	IV		
			65..	Saddle leather (65..)	IV		
			56..	Nubuk-Touch leather (56..)	IV		

The interior carcass of the versions pure white lacquer, white lacquer, high-gloss pure white lacquer and high-gloss white lacquer is in a matt white lacquer version. The same applies to the straight outer side of the lowboards with rounded end at one side.

The interior carcass of the versions grey lacquer, silk grey lacquer, high-gloss grey lacquer and high-gloss silk grey lacquer as well as of the accent units in leather version is in a matt grey lacquer version. The same applies to the straight outer side of the lowboards with rounded end at one side.

Leather versions: see next page!

Leather collection

Type of material Leather no.	Material identification Colour
Leather (51..)	100% Nappa leather, pigmented
5101	beige
5104	anthracite
5105	black
5106	red
5108	white
5109	cream
5110	mocca
5114	grey brown
5116	kiwi green
5118	chestnut brown
5119	nougat
5121	curry
5122	sand
5123	brown black
5125	grey
5126	medium mocca
Saddle leather (65..)	100% Saddle leather, semi-aniline
6501	black
6502	mocca
6503	cognac
6504	natural brown
6505	cream
6506	nougat
6508	sand

Type of material Leather no.	Material identification Colour
Nubuk-Touch leather (56..)	100% leather
5610	white
5611	light beige
5612	khaki
5613	dark brown
5614	olive
5615	ochre
5616	anthracite
5617	black

Important notes

Glass versions:

Outer glass sides of (wall) cabinets, **glass shelves** behind fronts as well as **bookshelves** and **glass accents** of wall shelf unit of bronzed glass.

Cabinet compartment rear wall and **bookshelf rear wall** of wall shelf unit also possible in all versions (exception: leather versions).

Accent units:

Carcase and front also in the versions knotted oak, knotted oak anthracite, knotted core walnut, Nappa leather, saddle leather and Nubuk-Touch leather possible.

Interior carcasse:

The interior carcasse of the versions pure white lacquer, white lacquer, high-gloss pure white lacquer and high-gloss white lacquer is in a matt white lacquer version. The same applies to the straight outer side of the lowboards with rounded end at one side. The interior carcasse of the versions grey lacquer, silk grey lacquer, high-gloss grey lacquer and high-gloss silk grey lacquer as well as of the accent units in leather version is in a matt grey lacquer version. The same applies to the straight outer side of the lowboards with rounded end at one side.

Standard interior fittings:

Fitted wooden shelves are fitted behind doors at intervals of 2 Raster (exception: 12 Raster cabinets).

Functional frame:

Functional frame always in white lacquer.

Wall units:

If units are planned as wall units, a wall bracket must be ordered.

Drawer frames in grey

Combinations of floor and wall units:

If floor and wall units are combined within an arrangement, there must not be any skirting boards in the room near the floor units, otherwise they must be removed.

Max. load:

Max. load of wooden and glass shelves (up to 70.4 cm width) as well as drawers: 25 kg
 Max. load of wooden and glass shelves (between 70.4 and 105.6 cm width): 15 kg;
 from 105.6 cm width: 10 kg
 Max. load of cover shelves: 35 kg per metre length for floor units.
 Please also note any maximum loads which may be stated in the type list for the individual units!

hülsta-Push-to-open:

Drawers and flap units with hülsta Push-to-open. All drawers on hidden roller bearings as fully pull-out units.

Labelling in type list drawings / assembly notes for wall units

Labelling in type list drawings / assembly notes for wall units

The majority of units have two wall mounting points (= number of base plates), if these are to be fitted as wall units. This is not explicitly mentioned in the type list. If a different number of wall mounting points (= base plates) is required, this is marked in the drawings in the type list with numbers in black boxes. Please be sure to note here the information and notes in the "Wall composition" chapter!

3

4

Notes on delivery

Notes on delivery:

The majority of the units are delivered standard as **fully connected units (glued)** so that the carcasse **cannot be disassembled**. There are however some **exceptions** to this rule:

Some carcasses are delivered as complete units but can be **disassembled into individual sections** in the final customer's home. These types are marked with a **1** in the type list.

1

Some carcasses are delivered in **individual sections** because of their size. These types are marked with a **2** in the type list.

2

The fronts with the number **2** are delivered separately and can therefore always be (dis-) assembled.

Wall fitting

Important notes: Generally speaking, you as a dealer/qualified fitter are responsible for the correct wall mounting of the units. That is why wall mounting should only be carried out by properly trained and qualified fitters. hülsta supplies materials for mounting units on walls for nearly all the units and which should be used for safety and for constructional reasons. The assembly materials supplied by hülsta (plugs, screws) are only suitable for fitting components on to concrete in firmness class C12/15. For other materials (please see separate materials table in the wall composition chapter) we provide you with an assembly mortar set as an extra order. Please note that this assembly mortar set is also only suitable for the materials listed in the materials table. If walls are made up of other materials (e.g. plastered or lighter wall materials), one should use another method of mounting better suited to the load on site. Please note that if the units are not mounted properly on the wall, there is a risk of the units falling down or tipping over – especially when alternative mounting materials acquired on site have been used. For the reasons stated above it is absolutely essential to enquire about the composition of any walls before signing any contracts.

Concept and possible arrangements

Unit as floor unit, with wall bracket for wall assembly or on metal substructure

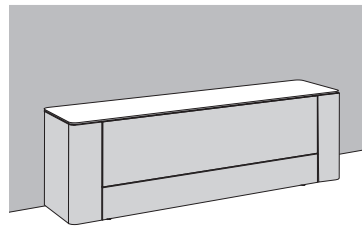
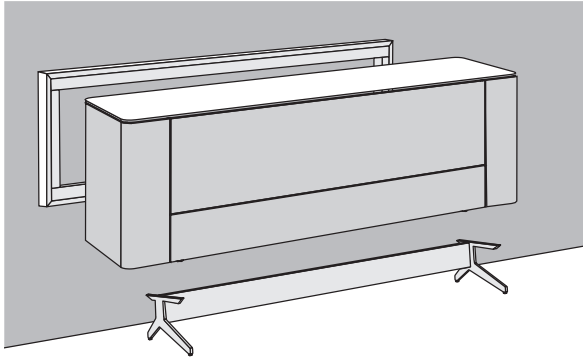

Unit as floor unit
incl. 1.8 cm high plinth adjusters

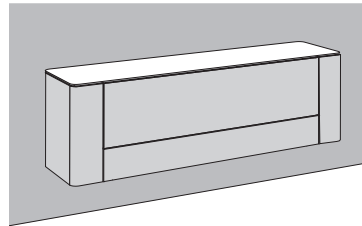

Unit with wall bracket for wall assembly
If the unit is planned as a wall unit, a wall bracket must be ordered. In this case the plinth adjusters are omitted.

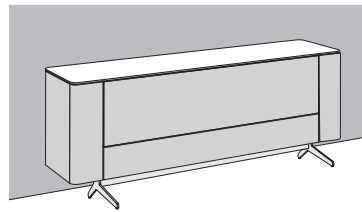

Unit on metal substructure
The units can be planned optionally on a metal substructure (19.4 cm high). In this case the plinth adjusters are omitted.

Notes on accent units, (wall) cabinets, wall shelf unit and 6 Raster wall units

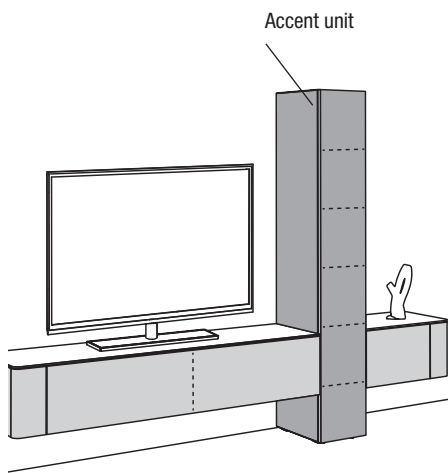

Accent unit

Notes on accent units:
Carcase and front also in the versions knotted oak, knotted oak anthracite, knotted core walnut, Nappa leather, saddle leather and Nubuk-Touch leather possible. The inside carcass of accent units in leather version is in matt grey lacquer. If accent units are required in a leather version, the unit width increases by 1.6 cm.

Accent

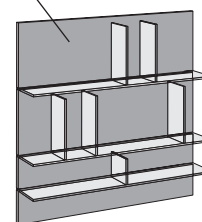

Notes on wall shelf unit:
Shelves and partitions of bronzed glass; shelf rear wall of wall unit possible in all versions (exception: leather versions).

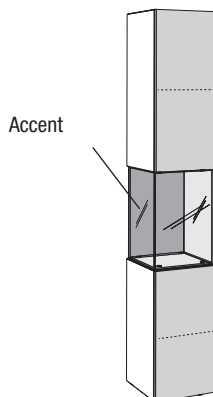

Accent

Notes on (wall) cabinets:
Outer glass sides of cabinets and glass shelves behind fronts of bronzed glass; cabinet compartment rear wall possible in all versions (exception: leather versions).

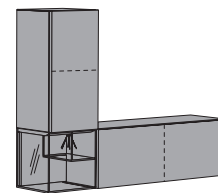

Notes on 6 Raster wall units:
6 Raster wall units are only available in the versions knotted oak, knotted oak anthracite and knotted core walnut. Glass compartment incl. integrated LED spotlamp. A remote control unit is essential for operation (against surcharge).

Functional frame

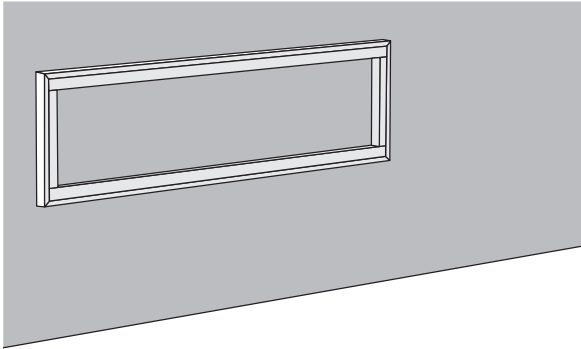

Functional frame

Functional frame for floor units of wood resp. for wall assembly of metal. Functional frame always in white lacquer.

The functional frame enables the following functions:

- Distance frame for a hovering look
- Inclusion of LED lamp
- Hiding cables

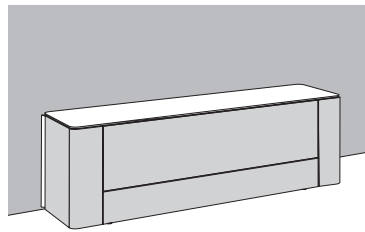

Unit with functional frame for floor units

The units can be planned optionally with a functional frame for floor units.

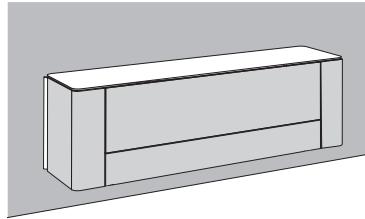

Unit with functional frame for wall assembly

If you plan a functional frame for wall assembly, you require an extra wall bracket. In this case the plinth adjusters are omitted.

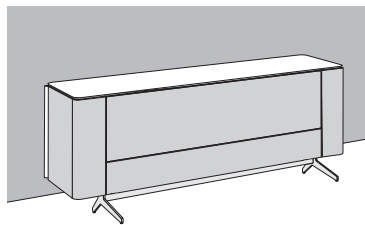

Unit with functional frame on metal substructure

The units with a functional frame can be planned optionally on a metal substructure (19.4 cm high). In this case the plinth adjusters are omitted.

LED lamps for functional frame

LED lamps for functional frame

The functional frame can be fitted with an optional LED lamp. LED lamp incl. footswitch. Lamp switch optionally with a remote control unit possible (against surcharge).

LED lamp of the functional frame for floor units:

3-sided lighting

LED lamp of the functional frame for wall assembly:

4-sided lighting

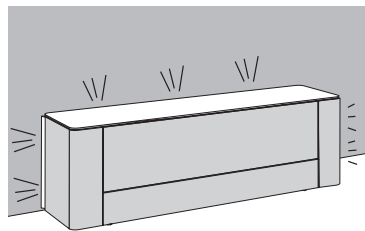

3-sided lighting of functional frame for floor units

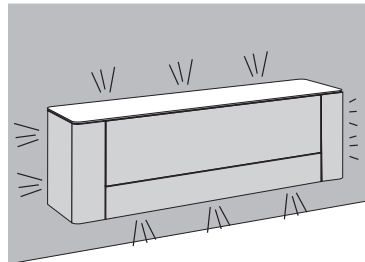

4-sided lighting of functional frame for wall assembly

NEW

Drawer and hinge-door for end units

Drawer and hinge-door for end units

The rounded end units of the low-, side- and highboards can optionally be fitted with drawers and/or hinge-doors.

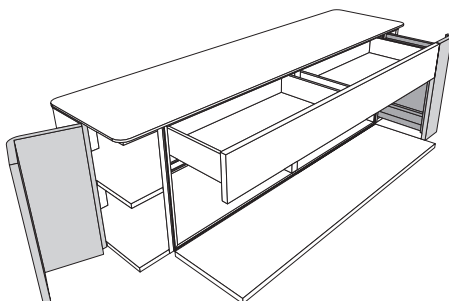

Lowboard with end units with drawers

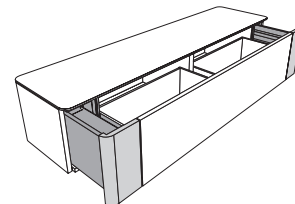

Sideboard with end units with hinge-doors

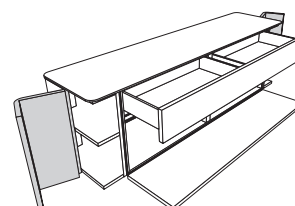

Suggested combinations

As an alternative to planning an individual unit from the complete range there is the possibility of choosing from specially suggested combinations. This eases planning. Incorporating accessories can enhance the suggested combinations. These are charged extra.

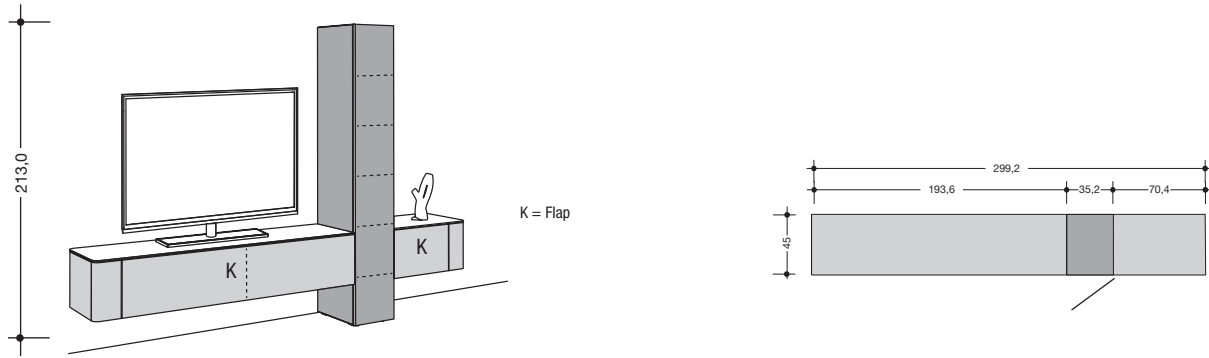

	Accent unit in lacquer version	Accent unit in wood and high-gloss lacquer version	Accent unit in knotted wood version	Accent unit in leather version
as illustr. v. versa	980001 980101	980001 980101	980001 980101	980001 980101
Price gr.	- -	- -	- -	- -

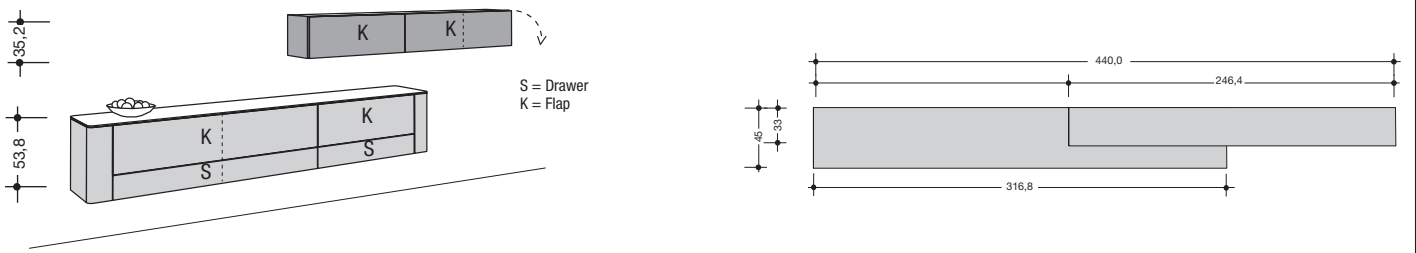

	Accent unit in lacquer version	Accent unit in wood and high-gloss lacquer version	Accent unit in knotted wood version	Accent unit in leather version
as illustr. v. versa	980002 980102	980002 980102	980002 980102	980002 980102
Price gr.	- -	- -	- -	- -

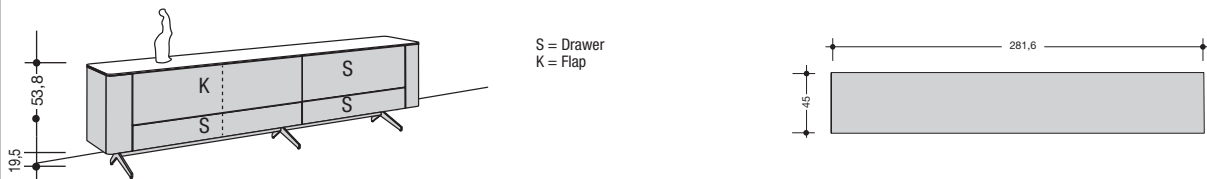

as illustr. v. versa	980003 980103
Price gr.	- -

Suggested combinations

As an alternative to planning an individual unit from the complete range there is the possibility of choosing from specially suggested combinations. This eases planning. Incorporating accessories can enhance the suggested combinations. These are charged extra.

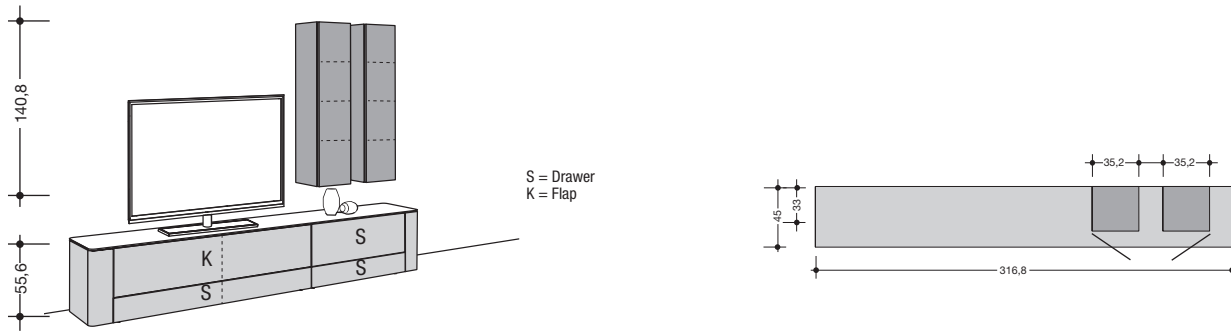

	Accent units in lacquer version	Accent units in wood and high-gloss lacquer version	Accent units in knotted wood version	Accent units in leather version
as illustr. v. versa	980004 980104	980004 980104	980004 980104	980004 980104
Price gr.	-	-	-	-
I	-	-	-	-
II	-	-	-	-

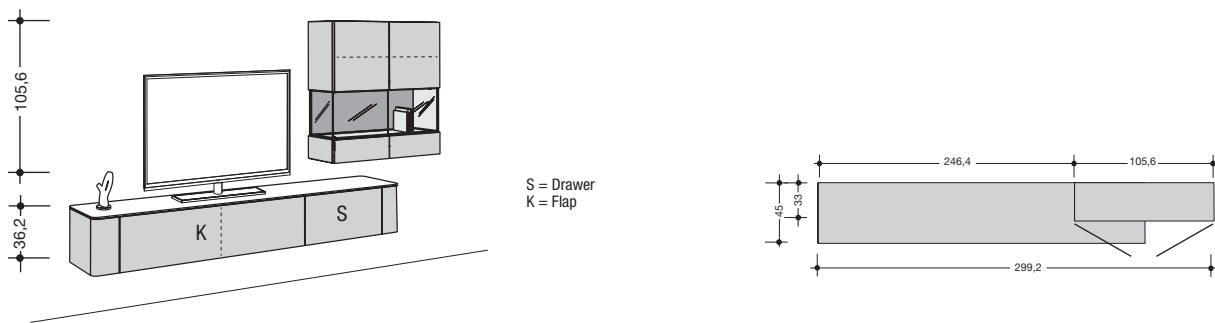

as illustr. v. versa	980005 980105
Price gr.	-
I	-
II	-

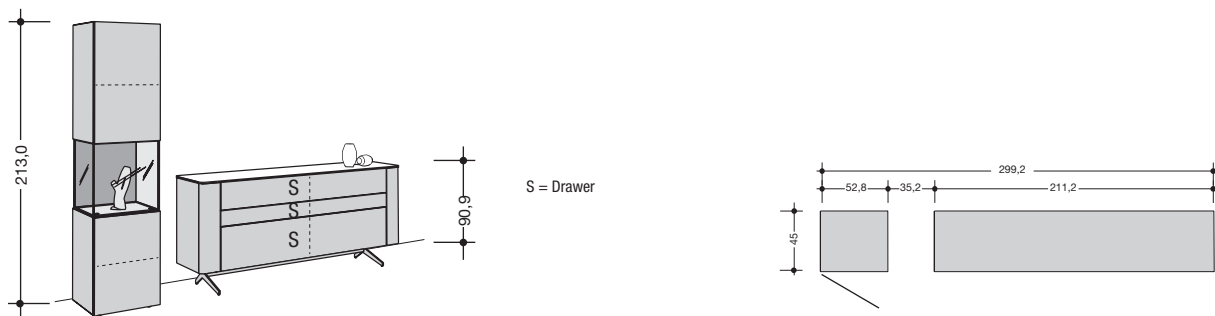

as illustr. v. versa	980006 980106
Price gr.	-
I	-
II	-

Suggested combinations

As an alternative to planning an individual unit from the complete range there is the possibility of choosing from specially suggested combinations. This eases planning. Incorporating accessories can enhance the suggested combinations. These are charged extra.

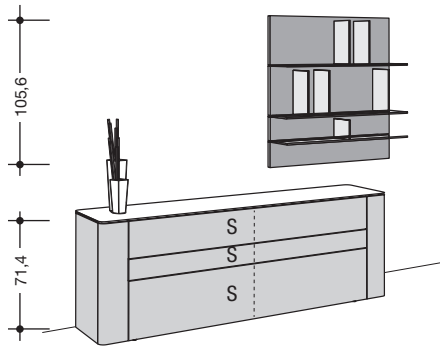

S = Drawer

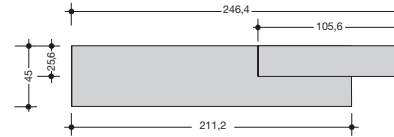

	Accent unit in lacquer version	Accent unit in wood and high-gloss lacquer version	Accent unit in knotted wood version	
as illustr. v. versa	980007 980107	980007 980107	980007 980107	
Price gr.	-	-	-	
I	-	-	-	
II	-	-	-	

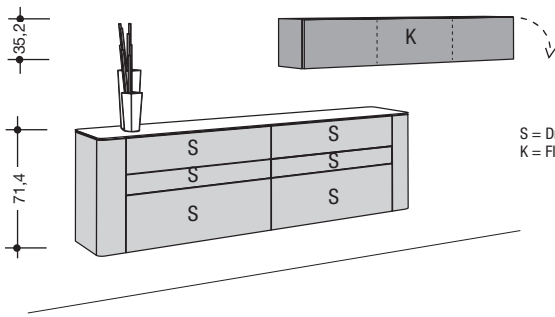

S = Drawer
K = Flap

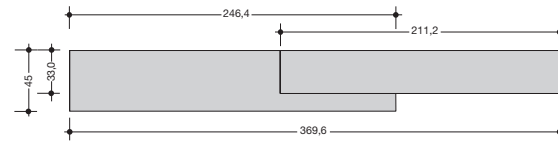

	Accent unit in lacquer version	Accent unit in wood and high-gloss lacquer version	Accent unit in knotted wood version	Accent unit in leather version
as illustr. v. versa	980008 980108	980008 980108	980008 980108	980008 980108
Price gr.	-	-	-	-
I	-	-	-	-
II	-	-	-	-

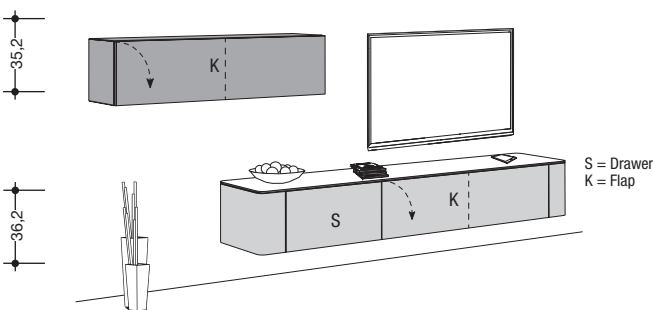

S = Drawer
K = Flap

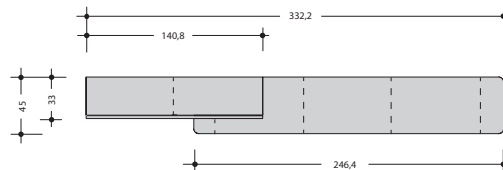

	Accent unit in lacquer version	Accent unit in wood and high-gloss lacquer version	Accent unit in knotted wood version	Accent unit in leather version
as illustr. v. versa	980009 980109	980009 980109	980009 980109	980009 980109
Price gr.	-	-	-	-
I	-	-	-	-
II	-	-	-	-

Suggested combinations

GENTIS

As an alternative to planning an individual unit from the complete range there is the possibility of choosing from specially suggested combinations. This eases planning. Incorporating accessories can enhance the suggested combinations. These are charged extra.

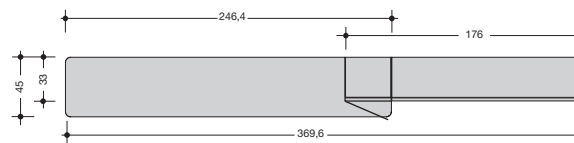
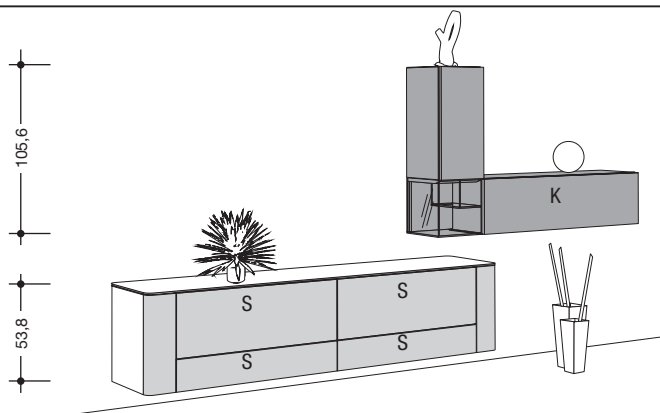

S = Drawer
K = Flap

	Accent unit in knotted wood version
as illustr. v. versa	980010 980110
Price gr.	-
I	-
II	-

Possible arrangements

















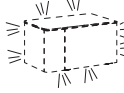
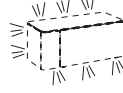
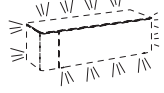

2 Raster lowboards with rounded end at one side

**2 Raster lowboards
with rounded end at one side**
36.2 cm high
(38.0 cm high incl. 1.8 cm high plinth adjusters),
45.0 cm deep

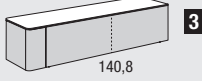



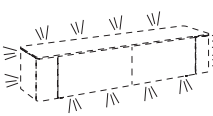
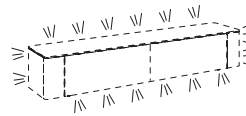





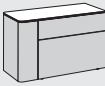
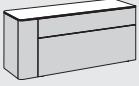

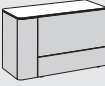
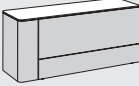
incl. cable aperture at centre of rear wall behind flap
per compartment





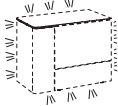
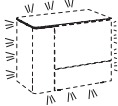
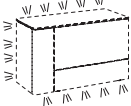
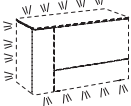
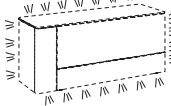
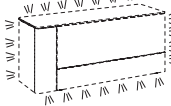

Wall units or wall assembly:
Please see here the information on pages 3-4

2 Raster lowboards with rounded end at one side 36.2 cm high (38.0 cm high incl. 1.8 cm high plinth adjusters), 45.0 cm deep incl. cable aperture at centre of rear wall behind flap per compartment Wall units or wall assembly: Please see here the information on pages 3-4	2 Raster lowboards with rounded end at one side					
	 52,8 70.4 cm wide		 70,4 88.0 cm wide		 105,6 123.2 cm wide	
	Flap hinge at bottom	1 drawer	1 flap	1 drawer	1 flap	1 drawer
as illustr. v. versa	27111 27112	27181 27182	28111 28112	28181 28182	212111 212112	212181 212182
Price gr. I II	- -	- -	- -	- -	- -	- -
Drawer for end unit left (L; as illustr.) or right (R; vice versa)	291L -	292R -	291L -	292R -	291L -	292R -
Hinge-door for end unit left (L; as illustr.) or right (R; vice versa)	281L -	282R -	281L -	282R -	281L -	282R -
Wall bracket If units are planned as wall units, a wall bracket must be ordered. Max. load: 40 kg	255 -		275 -		2105 -	
Functional frame for floor units The units can be planned optionally with a functional frame for floor units. Functional frame for wall assembly If you plan a functional frame for wall assembly, you require an extra wall bracket. In this case the plinth adjusters are omitted. Max. load: 40 kg Please note the further information on functional frames on page 5.						
	Functional frame for floor units	Functional frame for wall assembly	Functional frame for floor units	Functional frame for wall assembly	Functional frame for floor units	Functional frame for wall assembly
	252 -	253 -	272 -	273 -	2102 -	2103 -
Lamp for functional frame The functional frame can be fitted with an optional LED lamp. LED lamp incl. footswitch. Lamp switch optionally with a remote control unit (against surcharge; see page 40). Later fitting not possible. This luminaire contains built-in LED lamps of the energy classes A++ to A. The lamps cannot be changed in the luminaire. 12 V	8.0 W 	12.0 W	9.5 W 	15.5 W	12.5 W 	21.0 W
	254 -		274 -		2104 -	
Metal substructure 19.4 cm high; High-gloss chrome The units can be planned optionally on a metal substructure. In this case the plinth adjusters are omitted.						
	251 -		271 -		2101 -	

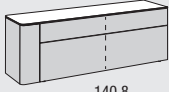

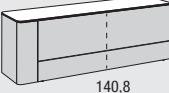
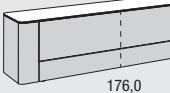
2 Raster lowboards with rounded end at one side					
					
		158.4 cm wide		193.6 cm wide	
	Flap hinge at bottom	1 drawer with split drawer frame	1 flap with 1 partition	1 drawer with split drawer frame	1 flap with 1 partition
		215111 215112	215181 215182	219111 219112	219181 219182
	Price gr.	-	-	-	-
		291L	292R	291L	292R
		-	-	-	-
		281L	282R	281L	282R
		-	-	-	-
		2145		2175	
		-		-	
					
		Functional frame for floor units	Functional frame for wall assembly	Functional frame for floor units	Functional frame for wall assembly
		2142	2143	2172	2173
		-	-	-	-
		14.5 W	24.0 W	16.0 W	27.0 W
					
		2144		2174	
		-		-	
					
		2141		2171	
		-		-	

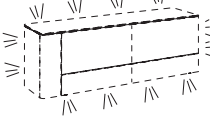
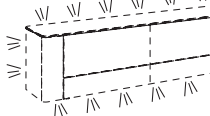
3 Raster lowboards with rounded end at one side

3 Raster lowboards with rounded end at one side 53.8 cm high (55.6 cm high incl. 1.8 cm high plinth adjusters), 45.0 cm deep incl. cable aperture at centre of rear wall behind flap per compartment Wall units or wall assembly: Please see here the information on pages 3-4		3 Raster lowboards with rounded end at one side					
		70.4 cm wide		88.0 cm wide		123.2 cm wide	
		 52,8 70.4 cm wide		 70,4 88.0 cm wide		 105,6 123.2 cm wide	
Flap hinge at bottom		Top: 1 drawer Bottom: 1 drawer	Top: 1 drawer Bottom: 1 flap	Top: 1 drawer Bottom: 1 drawer	Top: 1 drawer Bottom: 1 flap	Top: 1 drawer Bottom: 1 drawer	Top: 1 drawer Bottom: 1 flap
as illustr. v. versa		37111 37112	37181 37182	38111 38112	38181 38182	312111 312112	312181 312182
Price gr. I II		- -	- -	- -	- -	- -	- -
		 52,8 70.4 cm wide		 70,4 88.0 cm wide		 105,6 123.2 cm wide	
Flap hinge at bottom		Top: 1 drawer Bottom: 1 drawer	Top: 1 flap Bottom: 1 drawer	Top: 1 drawer Bottom: 1 drawer	Top: 1 flap Bottom: 1 drawer	Top: 1 drawer Bottom: 1 drawer	Top: 1 flap Bottom: 1 drawer
as illustr. v. versa		37211 37212	37281 37282	38211 38212	38281 38282	312211 312212	312281 312282
Price gr. I II		- -	- -	- -	- -	- -	- -
Drawer for end unit left (L; as illustr.) or right (R; vice versa)		391L	392R	391L	392R	391L	392R
Hinge-door for end unit left (L; as illustr.) or right (R; vice versa)		381L	382R	381L	382R	381L	382R
Wall bracket If units are planned as wall units, a wall bracket must be ordered. Max. load: 40 kg		255		275		2105	
Functional frame for floor units The units can be planned optionally with a functional frame for floor units. Functional frame for wall assembly If you plan a functional frame for wall assembly, you require an extra wall bracket. In this case the plinth adjusters are omitted. Max. load: 40 kg Please note the further information on functional frames on page 5.							
		Functional frame for floor units	Functional frame for wall assembly	Functional frame for floor units	Functional frame for wall assembly	Functional frame for floor units	Functional frame for wall assembly
		352	353	372	373	3102	3103
		-	-	-	-	-	-
Lamp for functional frame The functional frame can be fitted with an optional LED lamp. LED lamp incl. footswitch. Lamp switch optionally with a remote control unit (against surcharge; see page 40). Later fitting not possible. This luminaire contains built-in LED lamps of the energy classes A++ to A. The lamps cannot be changed in the luminaire. 12 V		11.0 W	15.5 W	12.5 W	18.0 W	15.0 W	23.5 W
							
		354		374		3104	
		-		-		-	
Metal substructure 19.4 cm high; High-gloss chrome The units can be planned optionally on a metal substructure. In this case the plinth adjusters are omitted.							
		251		271		2101	
		-		-		-	

3 Raster lowboards with rounded end at one side					
		 <p>140,8 158.4 cm wide</p>		 <p>176,0 193.6 cm wide</p>	
Flap hinge at bottom	<p>Top: 1 drawer with split drawer frame Bottom: 1 drawer with split drawer frame</p>	<p>Top: 1 drawer with split drawer frame Bottom: 1 flap with 1 partition</p>	<p>Top: 1 drawer with split drawer frame Bottom: 1 drawer with split drawer frame</p>	<p>Top: 1 drawer with split drawer frame Bottom: 1 flap with 1 partition</p>	
Price gr.	<p>315111 315112</p> <p>- -</p>	<p>315181 315182</p> <p>- -</p>	<p>319111 319112</p> <p>- -</p>	<p>319181 319182</p> <p>- -</p>	
		 <p>140,8 158.4 cm wide</p>		 <p>176,0 193.6 cm wide</p>	
Flap hinge at bottom	<p>Top: 1 drawer with split drawer frame Bottom: 1 drawer with split drawer frame</p>	<p>Top: 1 flap with 1 partition Bottom: 1 drawer with split drawer frame</p>	<p>Top: 1 drawer with split drawer frame Bottom: 1 drawer with split drawer frame</p>	<p>Top: 1 flap with 1 partition Bottom: 1 drawer with split drawer frame</p>	
Price gr.	<p>315211 315212</p> <p>- -</p>	<p>315281 315282</p> <p>- -</p>	<p>319211 319212</p> <p>- -</p>	<p>319281 319282</p> <p>- -</p>	
		<p>391L</p> <p>-</p>	<p>392R</p> <p>-</p>	<p>391L</p> <p>-</p>	<p>392R</p> <p>-</p>
		<p>381L</p> <p>-</p>	<p>382R</p> <p>-</p>	<p>381L</p> <p>-</p>	<p>382R</p> <p>-</p>
		<p>2145</p> <p>-</p>		<p>2175</p> <p>-</p>	
					
		<p>Functional frame for floor units</p>	<p>Functional frame for wall assembly</p>	<p>Functional frame for floor units</p>	<p>Functional frame for wall assembly</p>
		<p>3142</p> <p>-</p>	<p>3143</p> <p>-</p>	<p>3172</p> <p>-</p>	<p>3173</p> <p>-</p>
		<p>16.0 W</p>	<p>26.5 W</p>	<p>18.5 W</p>	<p>30.0 W</p>
					
		<p>3144</p> <p>-</p>		<p>3174</p> <p>-</p>	
					
		<p>2141</p> <p>-</p>		<p>2171</p> <p>-</p>	

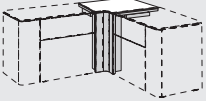
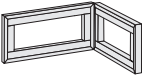
2 and 3 Raster corner units

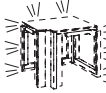
<p>2 and 3 Raster corner units 36.2 or 53.8 cm high (38.0 or 55.6 cm high incl. 1.8 cm high plinth adjusters), 45.0 cm deep</p> <p>Wall units or wall assembly: Please see here the information on pages 3-4</p> <p>Corner shelf incl. vertical cover panel If 2 and 3 Raster GENTIS units are fitted round a corner, it is possible to fit corner shelves incl. vertical panels (non-accessible corner). Only units of the same height can be fitted round the corner.</p>		2 Raster corner units	3 Raster corner units
		 <p>56.2 x 56.2 cm wide</p> <p>Corner shelf incl. vertical cover panel</p>	 <p>56.2 x 56.2 cm wide</p> <p>Corner shelf incl. vertical cover panel</p>
<p>Price gr.</p> <p>I</p> <p>II</p>	<p>266</p> <p>-</p> <p>-</p>	<p>366</p> <p>-</p> <p>-</p>	
<p>Functional frame for corners The units can be planned optionally with a functional frame for floor units.</p> <p>Functional frame for wall assembly If you plan a functional frame for wall assembly for the 2 and 3 Raster corner units, you do not require an extra wall bracket.</p> <p>Max. load: 40 kg</p> <p>Please note the further information on functional frames on page 5.</p>		 <p>Functional frame for floor units and wall assembly</p> <p>262</p> <p>-</p> <p>26.0 W</p>  <p>264</p> <p>-</p>	 <p>Functional frame for floor units and wall assembly</p> <p>362</p> <p>-</p> <p>30.0 W</p>  <p>364</p> <p>-</p>
<p>Lamp for functional frame The functional frame can be fitted with an optional LED lamp. LED lamp incl. footswitch. Lamp switch optionally with a remote control unit (against surcharge; see page 40). Later fitting not possible.</p> <p>This luminaire contains built-in LED lamps of the energy classes A++ to A. The lamps cannot be changed in the luminaire. 12 V</p>			



2 Raster lowboards with rounded end at both sides

**2 Raster lowboards
with rounded end at both sides**
36.2 cm high
(38.0 cm high incl. 1.8 cm high plinth adjusters),
45.0 cm deep

incl. cable aperture at centre of rear wall behind flap
per compartment

Wall units or wall assembly:
Please see here the information on pages 3-4

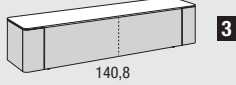
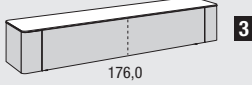
2 Raster lowboards with rounded end at both sides				
	 140,8 176.0 cm wide		 176,0 211.2 cm wide	
Flap hinge at bottom	1 drawer with split drawer frame	1 flap with 1 partition	1 drawer with split drawer frame	1 flap with 1 partition
	21721	21728	22121	22128
Price gr.	-	-	-	-
II	-	-	-	-

NEW

Drawer for end unit
optionally left (L) and/or right (R)

291L **292R**
- -

291L **292R**
- -

NEW

Hinge-door for end unit
optionally left (L) and/or right (R)

281L **282R**
- -

281L **282R**
- -

Wall bracket
If units are planned as wall units, a wall bracket must be ordered.

Max. load: 40 kg

2145
-

2175
-

Functional frame for floor units
The units can be planned optionally with a functional frame for floor units.

Functional frame for wall assembly
If you plan a functional frame for wall assembly, you require an extra wall bracket. In this case the plinth adjusters are omitted.

Max. load: 40 kg

Please note the further information on functional frames on page 5.



Functional frame for floor units

Functional frame for wall assembly

Functional frame for floor units

Functional frame for wall assembly

2142
-

2143
-

2172
-

2173
-

Lamp for functional frame
The functional frame can be fitted with an optional LED lamp. LED lamp incl. footswitch. Lamp switch optionally with a remote control unit (against surcharge; see page 40). Later fitting not possible.

This luminaire contains built-in LED lamps of the energy classes A++ to A. The lamps cannot be changed in the luminaire. 12 V

14.5 W

24.0 W

16.0 W

27.0 W

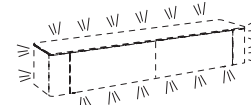
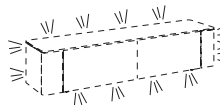

2144
-

2174
-

Metal substructure





19.4 cm high;
High-gloss chrome

The units can be planned optionally on a metal substructure. In this case the plinth adjusters are omitted.

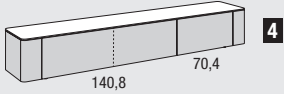
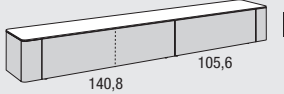
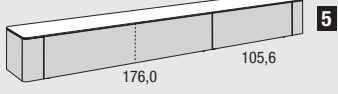

2141
-

2171
-

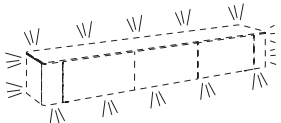
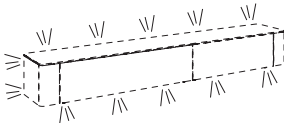
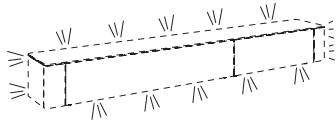
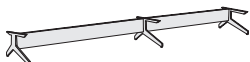
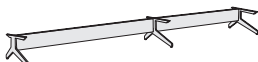
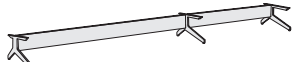
2 Raster lowboards with rounded end at both sides											
											
		246.4 cm wide			281.6 cm wide			316.8 cm wide			
Flap hinge at bottom	2 drawers (wide drawer with split drawer frame)	2 flaps (wide flap with 1 partition)	1 flap with 1 partition, 1 drawer	2 drawers (wide drawer with split drawer frame)	2 flaps (wide flap with 1 partition)	1 flap with 1 partition, 1 drawer	2 drawers (wide drawer with split drawer frame)	2 flaps (wide flap with 1 partition)	1 flap with 1 partition, 1 drawer		
as illustr. v. versa	224211 224212	224281 224282	224271 224272	228211 228212	228281 228282	228271 228272	231211 231212	231281 231282	231271 231272		
Price gr. I II	- -	- -	- -	- -	- -	- -	- -	- -	- -		
	291L		292R	291L		292R	291L		292R		
	-		-	-		-	-		-		
	281L		282R	281L		282R	281L		282R		
	-		-	-		-	-		-		
		2215			2245			2285			
		-			-			-			
											
	Functional frame for floor units		Functional frame for wall assembly	Functional frame for floor units		Functional frame for wall assembly	Functional frame for floor units		Functional frame for wall assembly		
	2212		2213	2242		2243	2282		2283		
	-		-	-		-	-		-		
	18.5 W		32.0 W	26.0 W		42.5 W	27.5 W		46.0 W		
											
		2214			2244			2284			
		-			-			-			
											
		2211			2241			2281			
		-			-			-			

3 Raster lowboards with rounded end at both sides

3 Raster lowboards with rounded end at both sides
 53.8 cm high
 (55.6 cm high incl. 1.8 cm high plinth adjusters),
 45.0 cm deep

incl. cable aperture at centre of rear wall behind flap per compartment

Wall units or wall assembly:
 Please see here the information on pages 3-4

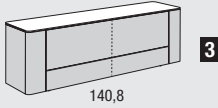
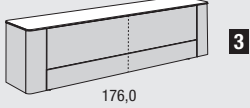
3 Raster lowboards with rounded end at both sides				
	 <p>140,8</p> <p>176.0 cm wide</p>		 <p>176,0</p> <p>211.2 cm wide</p>	
Flap hinge at bottom	2 drawers with split drawer frames	Top: 1 flap with 1 partition Bottom: 1 drawer with split drawer frame	2 drawers with split drawer frames	Top: 1 flap with 1 partition Bottom: 1 drawer with split drawer frame
	31711	31718	32111	32118
Price gr.	-	-	-	-
	-	-	-	-

NEW

Drawer for end unit
 optionally left (L) and/or right (R)

	391L	392R	391L	392R
	-	-	-	-

NEW

Hinge-door for end unit
 optionally left (L) and/or right (R)

	381L	382R	381L	382R
	-	-	-	-

Wall bracket
 If units are planned as wall units, a wall bracket must be ordered.
 Max. load: 40 kg

	2145	2175
	-	-

Functional frame for floor units
 The units can be planned optionally with a functional frame for floor units.

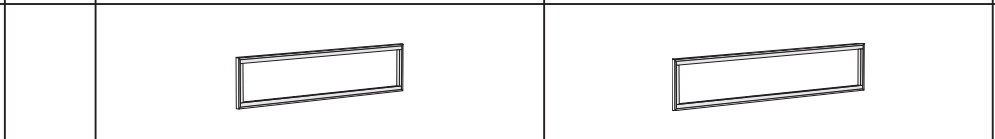

Functional frame for wall assembly
 If you plan a functional frame for wall assembly, you require an extra wall bracket. In this case the plinth adjusters are omitted.

	Functional frame for floor units	Functional frame for wall assembly	Functional frame for floor units	Functional frame for wall assembly
--	----------------------------------	------------------------------------	----------------------------------	------------------------------------

Max. load: 40 kg
 Please note the further information on functional frames on page 5.

	3142	3143	3172	3173
	-	-	-	-

Lamp for functional frame
 The functional frame can be fitted with an optional LED lamp. LED lamp incl. footswitch. Lamp switch optionally with a remote control unit (against surcharge; see page 40). Later fitting not possible.

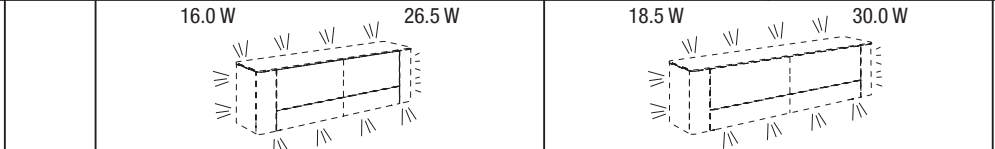

This luminaire contains built-in LED lamps of the energy classes A++ to A. The lamps cannot be changed in the luminaire. 12 V

	3144	3174
	-	-

Metal substructure
 19.4 cm high;
 High-gloss chrome

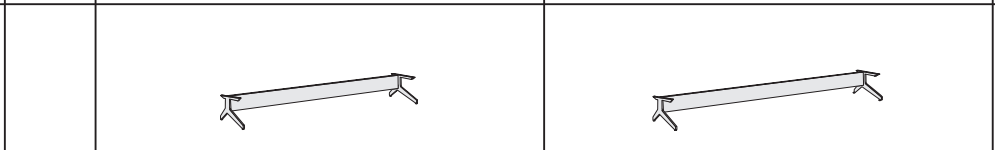

The units can be planned optionally on a metal substructure. In this case the plinth adjusters are omitted.

	2141	2171
	-	-

Notes on delivery:
Please see here the information on range introduction pages.

1
2

Assembly notes for wall units:
Please be sure to note here the information and notes in the "Wall composition" chapter!

3
4

3 Raster lowboards with rounded end at both sides

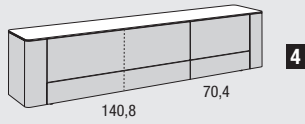

246.4 cm wide

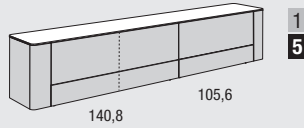

281.6 cm wide

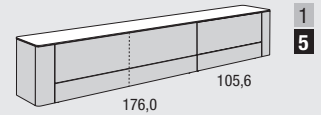

316.8 cm wide

Flap hinge at bottom	4 drawers (wide drawers with split drawer frames)	Top: 2 flaps (wide flap with 1 partition) Bottom: 2 drawers (wide drawer with split drawer frame)	Top: 1 flap with 1 partition, 1 drawer Bottom: 2 drawers (wide drawer with split drawer frame)	4 drawers (wide drawers with split drawer frames)	Top: 2 flaps (wide flap with 1 partition) Bottom: 2 drawers (wide drawer with split drawer frame)	Top: 1 flap with 1 partition, 1 drawer Bottom: 2 drawers (wide drawer with split drawer frame)	4 drawers (wide drawers with split drawer frames)	Top: 2 flaps (wide flap with 1 partition) Bottom: 2 drawers (wide drawer with split drawer frame)	Top: 1 flap with 1 partition, 1 drawer Bottom: 2 drawers (wide drawer with split drawer frame)
	as illustr. v. versa	324111 324112	324181 324182	324171 324172	328111 328112	328181 328182	328171 328172	331111 331112	331181 331182

Price gr.	-	-	-	-	-	-	-	-	-	-
-----------	---	---	---	---	---	---	---	---	---	---

	391L	392R		391L	392R		391L	392R
--	------	------	--	------	------	--	------	------

	381L	382R		381L	382R		381L	382R
--	------	------	--	------	------	--	------	------

	2215			2245			2285	
--	------	--	--	------	--	--	------	--

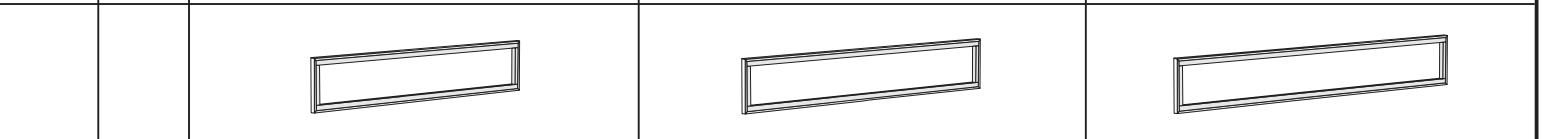

	Functional frame for floor units	Functional frame for wall assembly		Functional frame for floor units	Functional frame for wall assembly		Functional frame for floor units	Functional frame for wall assembly
--	----------------------------------	------------------------------------	--	----------------------------------	------------------------------------	--	----------------------------------	------------------------------------

	3212	3213		3242	3243		3282	3283
--	------	------	--	------	------	--	------	------

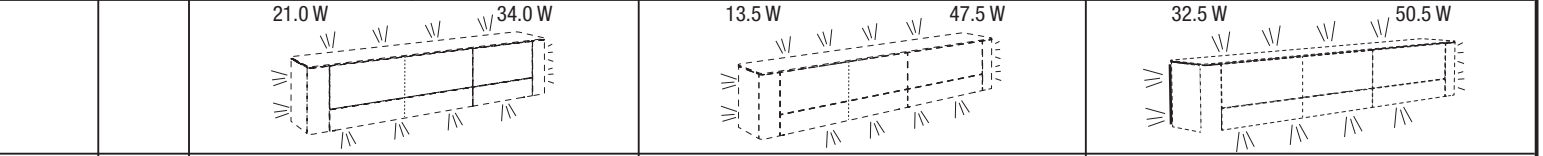

	3214			3244			3284	
--	------	--	--	------	--	--	------	--

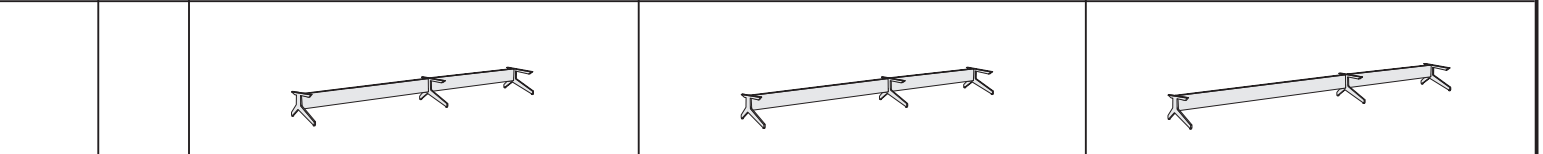





	2211			2241			2281	
--	------	--	--	------	--	--	------	--

3 Raster lowboards with rounded end at both sides

3 Raster lowboards with rounded end at both sides
 53.8 cm high
 (55.6 cm high incl. 1.8 cm high plinth adjusters),
 45.0 cm deep

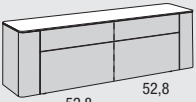
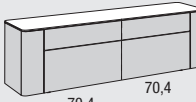
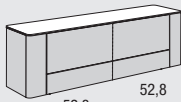
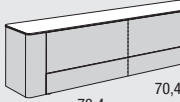
incl. cable aperture at centre of rear wall behind flap per compartment

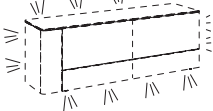
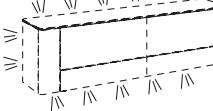
Wall units or wall assembly:
 Please see here the information on pages 3-4

3 Raster lowboards with rounded end at both sides						
 <p>52,8 52,8 140.8 cm wide</p>		 <p>70,4 70,4 176.0 cm wide</p>				
Flap hinge at bottom	4 drawers	Top: 2 drawers Bottom: 2 flaps	Top: 2 drawers Bottom: 1 flap, 1 drawer	4 drawers	Top: 2 drawers Bottom: 2 flaps	Top: 2 drawers Bottom: 1 flap, 1 drawer
as illustr. v. versa	31451	31458	314571 314572	31751	31758	317571 317572
Price gr.	-	-	-	-	-	-
	-	-	-	-	-	-
 <p>52,8 52,8 140.8 cm wide</p>		 <p>70,4 70,4 176.0 cm wide</p>				
Flap hinge at bottom	4 drawers	Top: 2 flaps Bottom: 2 drawers	Top: 1 flap, 1 drawer Bottom: 2 drawers	4 drawers	Top: 2 flaps Bottom: 2 drawers	Top: 1 flap, 1 drawer Bottom: 2 drawers
as illustr. v. versa	31461	31468	314671 314672	31761	31768	317671 317672
Price gr.	-	-	-	-	-	-
	-	-	-	-	-	-
Drawer for end unit optionally left (L) and/or right (R)	391L	392R		391L	392R	
	-	-		-	-	
Hinge-door for end unit optionally left (L) and/or right (R)	381L	382R		381L	382R	
	-	-		-	-	
Wall bracket If units are planned as wall units, a wall bracket must be ordered. Max. load: 40 kg		2105			2145	
		-			-	
Functional frame for floor units The units can be planned optionally with a functional frame for floor units.						
Functional frame for wall assembly If you plan a functional frame for wall assembly, you require an extra wall bracket. In this case the plinth adjusters are omitted. Max. load: 40 kg	Functional frame for floor units	Functional frame for wall assembly		Functional frame for floor units	Functional frame for wall assembly	
Please note the further information on functional frames on page 5.	3102	3103		3142	3143	
	-	-		-	-	
Lamp for functional frame The functional frame can be fitted with an optional LED lamp. LED lamp incl. footswitch. Lamp switch optionally with a remote control unit (against surcharge; see page 40). Later fitting not possible. This luminaire contains built-in LED lamps of the energy classes A++ to A. The lamps cannot be changed in the luminaire. 12 V	15.0 W	23.5 W		16.0 W	26.5 W	
			3104		3144	
			-		-	
Metal substructure 19.4 cm high; High-gloss chrome The units can be planned optionally on a metal substructure. In this case the plinth adjusters are omitted.						
			2101		2141	
			-		-	

NEW



NEW

Notes on delivery:
Please see here the information on range introduction pages.

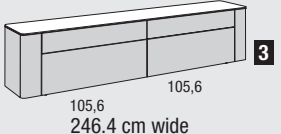
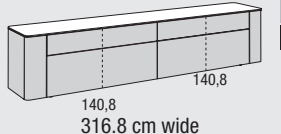
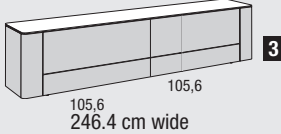
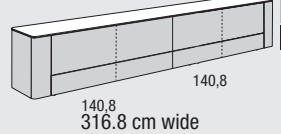

1
2

Assembly notes for wall units:
Please be sure to note here the information and notes in the "Wall composition" chapter!

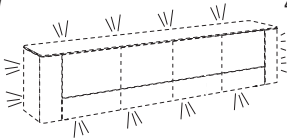
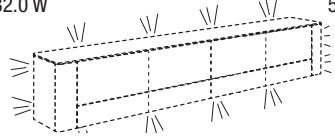
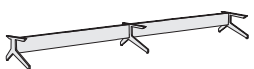
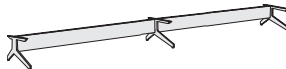
3
4

3 Raster lowboards with rounded end at both sides						
						
Flap hinge at bottom	4 drawers	Top: 2 drawers Bottom: 2 flaps	Top: 2 drawers Bottom: 1 flap, 1 drawer	4 drawers with split drawer frames	Top: 2 drawers with split drawer frames Bottom: 2 flaps with 1 partition	Top: 2 drawers with split drawer frames Bottom: 1 flap with 1 partition, 1 drawer with split drawer frame
as illustr. v. versa	32451	32458	324571 324572	33151	33158	331571 331572
Price gr. I	-	-	-	-	-	-
Price gr. II	-	-	-	-	-	-
						
Flap hinge at bottom	4 drawers	Top: 2 flaps Bottom: 2 drawers	Top: 1 flap, 1 drawer Bottom: 2 drawers	4 drawers with split drawer frames	Top: 2 flaps with 1 partition Bottom: 2 drawers with split drawer frames	Top: 1 flap with 1 partition, 1 drawer with split drawer frame Bottom: 2 drawers with split drawer frames
as illustr. v. versa	32461	32468	324671 324672	33161	33168	331671 331672
Price gr. I	-	-	-	-	-	-
Price gr. II	-	-	-	-	-	-
	391L		392R	391L		392R
	-		-	-		-
	381L		382R	381L		382R
	-		-	-		-
		2215			2285	
		-			-	
						
	Functional frame for floor units		Functional frame for wall assembly	Functional frame for floor units		Functional frame for wall assembly
	3212		3213	3282		3283
	-		-	-		-
	28.5 W		42.5 W	32.0 W		53.0 W
						
		3214			3284	
		-			-	
						
		2211			2281	
		-			-	

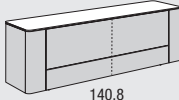
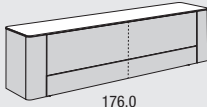
3 Raster room divider lowboards with rounded end at both sides

3 Raster room divider lowboards with rounded end at both sides 53.8 cm high (55.6 cm high incl. 1.8 cm high plinth adjusters), 45.0 cm deep Note on room divider units: Rear view same as front view (front divisions).	3 Raster room divider lowboards with rounded end at both sides				
	 140,8 176.0 cm wide		 176,0 211.2 cm wide		
	Flap hinge at bottom	2 drawers with split drawer frames	Top: 1 flap with 1 partition Bottom: 1 drawer with split drawer frame	2 drawers with split drawer frames	Top: 1 flap with 1 partition Bottom: 1 drawer with split drawer frame
	Price gr.	31721	31728	32121	32128
	-	-	-	-	
	-	-	-	-	
NEW Drawer for end unit optionally left (L) and/or right (R)	391L	392R	391L	392R	
	-	-	-	-	
NEW Hinge-door for end unit optionally left (L) and/or right (R)	381L	382R	381L	382R	
	-	-	-	-	
Metal substructure 19.4 cm high; High-gloss chrome The units can be planned optionally on a metal substructure. In this case the plinth adjusters are omitted.	 2141 -		 2171 -		

Notes on delivery:
Please see here the information on range introduction pages.

1
2

3 Raster room divider lowboards with rounded end at both sides											
		<p>140,8 70,4</p> <p>246.4 cm wide</p>			<p>140,8 105,6</p> <p>281.6 cm wide</p>			<p>176,0 105,6</p> <p>316.8 cm wide</p>			
Flap hinge at bottom	4 drawers (wide drawers with split drawer frames)	Top: 2 flaps (wide flap with 1 partition) Bottom: 2 drawers (wide drawer with split drawer frame)	Top: 1 flap with 1 partition, 1 drawer Bottom: 2 drawers (wide drawer with split drawer frame)	4 drawers (wide drawers with split drawer frames)	Top: 2 flaps (wide flap with 1 partition) Bottom: 2 drawers (wide drawer with split drawer frame)	Top: 1 flap with 1 partition, 1 drawer Bottom: 2 drawers (wide drawer with split drawer frame)	4 drawers (wide drawers with split drawer frames)	Top: 2 flaps (wide flap with 1 partition) Bottom: 2 drawers (wide drawer with split drawer frame)	Top: 1 flap with 1 partition, 1 drawer Bottom: 2 drawers (wide drawer with split drawer frame)		
as illustr. v. versa	324211 324212	324281 324282	324271 324272	328211 328212	328281 328282	328271 328272	331211 331212	331281 331282	331271 331272		
Price gr.	- -	- -	- -	- -	- -	- -	- -	- -	- -		
	391L	392R		391L	392R		391L	392R			
	-	-		-	-		-	-			
	381L	382R		381L	382R		381L	382R			
	-	-		-	-		-	-			
	<p>221</p>			<p>2241</p>			<p>2281</p>				

Media accessories for lowboards

Multiple socket

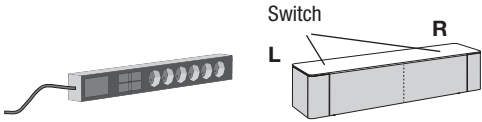
<p>Multiple socket Fitting of multiple socket in lowboards in front of rear wall optionally left (L) or right (R) in the compartment behind flap, fitting of switch in wooden cover shelf, optionally left or right (see sketch). Please state the required position clearly in the order! 7.4 cm high, 44.6 cm long, 5.7 cm deep</p>		<p>Multiple socket with on/off function all 6 sockets permanent current</p>
		<p>291 L 292 R -</p>

IR repeater set

<p>IR repeater set Infrared signal transmission set for operating media units behind wooden/lacquered fronts. You can operate all the units in one compartment with one set. The following applies:</p> <ul style="list-style-type: none"> • One set must be used in each compartment. 2 transmitters can also be installed in large compartments in order to increase performance. In this case only one additional transmitter needs to be ordered. • The transmitter must be placed in the direct vicinity of the receiver eye. • Transmittable IR frequency band 20 – 60 kHz • Up to 3 transmitters can be combined with one receiver. <p>It is possible to use 3 transmitters via 1 receiver including Master box. This enables simultaneous operation of 3 different furniture compartments or in critical situations it allows fitting out one furniture compartment with several transmitters in order to increase the performance in this compartment or to operate 2 end units placed next to one another.</p> <p>The IR repeater set consists of:</p> <ul style="list-style-type: none"> • 1 receiver eye (Ø 3.0 cm) incl. standing bracket • 1 electrical transmitter • 1 plug EVG 12 V • Cable clips <p>Please note the details stated in the operating instructions!</p>	<table border="1"> <tr> <td data-bbox="1333 645 1523 764"> <p>IR repeater set 1 receiver eye and 1 transmitter incl. standing bracket</p> </td> </tr> <tr> <td data-bbox="1333 764 1523 883"> <p>2001 -</p> </td> </tr> <tr> <td data-bbox="1333 883 1523 934"> <p>Extra transmitter</p> </td> </tr> <tr> <td data-bbox="1333 934 1523 1040"> <p>2003 -</p> </td> </tr> </table>	<p>IR repeater set 1 receiver eye and 1 transmitter incl. standing bracket</p>	<p>2001 -</p>	<p>Extra transmitter</p>	<p>2003 -</p>
<p>IR repeater set 1 receiver eye and 1 transmitter incl. standing bracket</p>					
<p>2001 -</p>					
<p>Extra transmitter</p>					
<p>2003 -</p>					

Cable apertures / subwoofer base cut-out section

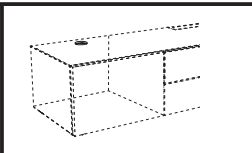
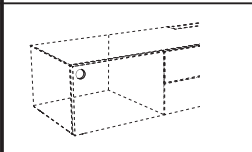
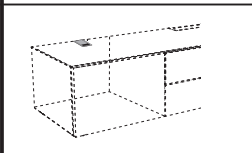
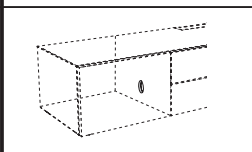
	<p>Cable aperture K1 silver-coloured; Ø 8.0 cm It is possible to fit a cable aperture in the top shelf of the lowboard. The cable aperture can be made at the rear of the top shelf. The position is in the centre of the compartment, distance from centre of aperture to rear edge of unit: 10.0 cm.</p>	<p>K1 -</p>
	<p>Cable aperture K2 silver-coloured; Ø 8.0 cm It is possible to fit a cable aperture in the rear wall of the lowboard. Positioned at centre of compartment.</p>	<p>K2 -</p>
	<p>Cable aperture K7 silver-coloured; 7.0 x 12.0 cm It is possible to fit a cable aperture in the top shelf of the lowboard. The position is in the centre of the compartment, flush with the rear edge of the unit.</p>	<p>K7 -</p>
	<p>Cable aperture K8 silver-coloured; 12.8 x 3.2 cm It is possible to fit a cable aperture in the top shelf of the lowboard. The cable aperture can be made at the rear rim of the top shelf. Positioned in centre of compartment.</p>	<p>K8 -</p>
	<p>Cable aperture K9 13.0 x 1.6 cm It is possible to fit a cable aperture in a fitted shelf. The cable aperture can be made at the rear rim of the fitted shelf. Positioned in centre of compartment.</p>	<p>K9 -</p>
	<p>Cable aperture K20 silver-coloured; Ø 8.0 cm It is possible to fit a cable aperture in the partitions of the lowboard.</p>	<p>K20 -</p>
	<p>Subwoofer base cut-out section Base cut-out section 12 x 23.2 cm The sounds from the subwoofer pass out through the base cut-out section in the lowboard without hindrance. The exact position in the carcass is predetermined ex-works and cannot be altered.</p>	<p>14 -</p>

TV columns

TV columns can be rotated and adjusted in angle, for fitting on **floor lowboards with partition** (not possible with 2 Raster lowboards with 2 drawers on top of one another and wall lowboards).
The TV column can only be fitted above a partition in the centre. The partition is provided with a cut-out section for cables (no surcharge). No drawers are possible below the TV column.

The revolving TV column 52 is suitable for flat screens with a screen diagonal of 38"-52" (96-132 cm), max. load: 35 kg
TV revolving column 52 compatible with VESA Norm standard:
min. 75 x 75 mm, max. 400 x 400 mm

The revolving TV column 65 is suitable for flat screens with a screen diagonal of 38"-65" (96-165 cm), max. load: 40 kg
TV revolving column 65 compatible with VESA Norm standard:
min. 75 x 75 mm, max. 800 x 400 mm

TV column 52

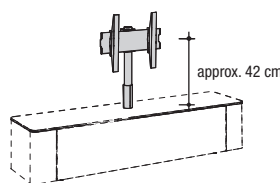

TV column 65

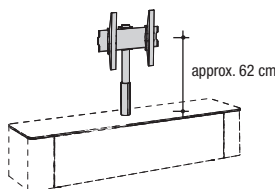

TV column 52	TV column 65
9404	9403
-	-

Column system, flat screen supports

Column system

consisting of a metal column (for fitting anywhere on wall) and of audio/DVD support(s), for fitting anywhere on column.

Example of use:

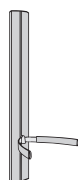

Columns

of metal; for fitting anywhere on walls above top rim of plinth slot; cables can be laid and hidden at any height; audio/DVD supports can be fitted anywhere on the column.



36.8 cm high

64.1 cm high

9201

9202

Audio/DVD support

of metal; can be positioned at any height on the column and be adjusted to suit audio/DVD players of any size; with rubber padding at front to prevent units from slipping; max. load: 10 kg



9203

Flat screen support WTL6

The flat screen support can be adjusted 3-dimensionally. It is suitable for flat screens with a screen diagonal of 102-216 cm (40"-85"); max. load: 45 kg.
Suitable for Curved TV's.
Flat screen support compatible with VESA Norm standard:
min.: 200 x 200 mm
max.: 600 x 400 mm

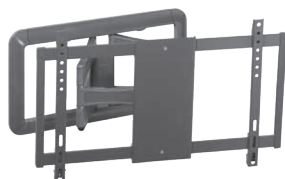

for fitting anywhere on walls

9704

Flat screen support THIN 345, ideally adaptable

The flat screen support can be adjusted 3-dimensionally. It is suitable for flat screens with a screen diagonal of 81-140 cm (32"-55") and a maximum depth of 4.5 cm; max. load: 25 kg.
Go to www.vogels.com to check if your flat screen can be fitted on this flat screen support. Enter the name THIN 345. After a few steps you can see if your flat screen TV is compatible with the flat screen support.
Not suitable for Curved TV's.
Flat screen support compatible with VESA Norm standard:
min.: 100 x 100 mm
max.: 600 x 400 mm

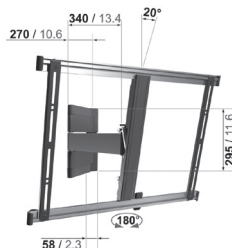

for fitting anywhere on walls

9304

Flat screen support THIN 315



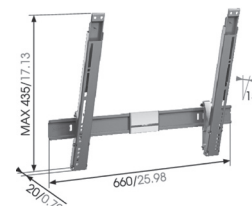





The flat screen support can be angled up to a max. 15°. It is suitable for flat screens with a screen diagonal of 102-165 cm (40"-65") and a maximum depth of 5.0 cm; max. load: 25 kg.
Go to www.vogels.com to check if your flat screen can be fitted on this flat screen support. Enter the name THIN 315. After a few steps you can see if your flat screen TV is compatible with the flat screen support.
Not suitable for Curved TV's.
Flat screen support compatible with VESA Norm standard:
min.: 100 x 100 mm
max.: 600 x 400 mm

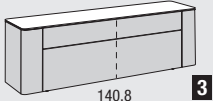
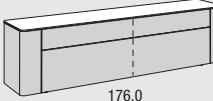
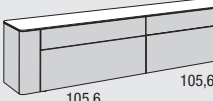

for fitting anywhere on walls

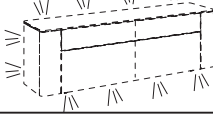
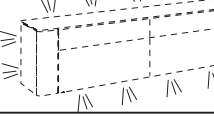
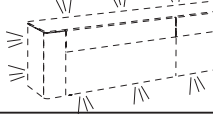
9504



3 Raster sideboards with rounded end at both sides

3 Raster sideboards with rounded end at both sides 53.8 cm high (55.6 cm high incl. 1.8 cm high plinth adjusters), 45.0 cm deep Wall units or wall assembly: Please see here the information on pages 3-4		3 Raster sideboards with rounded end at both sides					
		 140,8 3 176.0 cm wide		 176,0 3 211.2 cm wide		 105,6 3 246.4 cm wide	
Flap hinge at bottom	2 drawers with split drawer frames	Top: 1 drawer with split drawer frame Bottom: 1 flap with 1 partition	2 drawers with split drawer frames	Top: 1 drawer with split drawer frame Bottom: 1 flap with 1 partition	4 drawers	Top: 2 drawers Bottom: 2 flaps	Top: 2 drawers Bottom: 1 drawer, 1 flap
as illustr. v. versa	31731	31738	32131	32138	32431	32438	324371 324372
Price gr. I II	-	-	-	-	-	-	-
NEW Drawer for end unit optionally left (L) and/or right (R)	391L	392R	391L	392R	391L	392R	
NEW Hinge-door for end unit optionally left (L) and/or right (R)	381L	382R	381L	382R	381L	382R	
Wall bracket If units are planned as wall units, a wall bracket must be ordered. Max. load: 40 kg	2145		2175		2215		
Functional frame for floor units The units can be planned optionally with a functional frame for floor units. Functional frame for wall assembly If you plan a functional frame for wall assembly, you require an extra wall bracket. In this case the plinth adjusters are omitted. Max. load: 40 kg Please note the further information on functional frames on page 5.							
	Functional frame for floor units	Functional frame for wall assembly	Functional frame for floor units	Functional frame for wall assembly	Functional frame for floor units	Functional frame for wall assembly	
	3142	3143	3172	3173	3212	3213	
Lamp for functional frame The functional frame can be fitted with an optional LED lamp. LED lamp incl. footswitch. Lamp switch optionally with a remote control unit (against surcharge; see page 40). Later fitting not possible. This luminaire contains built-in LED lamps of the energy classes A++ to A. The lamps cannot be changed in the luminaire. 12 V	16.0 W 26.5 W 	19.0 W 30.0 W 	28.5 W 42.5 W 				
	3144		3174		3214		
Metal substructure 19.4 cm high; High-gloss chrome The units can be planned optionally on a metal substructure. In this case the plinth adjusters are omitted.							
	2141		2171		2211		

3 Raster room divider sideboards with rounded end at both sides

Assembly notes for wall units:
Please be sure to note here the information
and notes in the "Wall composition" chapter!

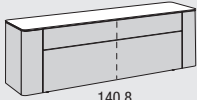
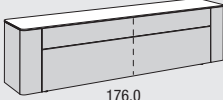
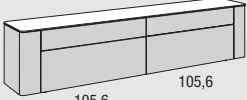
GENTIS

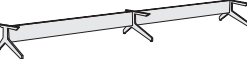
3 Raster room divider sideboards with rounded end at both sides 53.8 cm high (55.6 cm high incl. 1.8 cm high plinth adjusters), 45.0 cm deep Note on room divider units: Rear view same as front view (front divisions).		3 Raster room divider sideboards with rounded end at both sides							
		 140,8 176.0 cm wide		 176,0 211.2 cm wide		 105,6 105,6 246.4 cm wide			
Flap hinge at bottom	2 drawers with split drawer frames	Top: 1 drawer with split drawer frame Bottom: 1 flap with 1 partition	2 drawers with split drawer frames	Top: 1 drawer with split drawer frame Bottom: 1 flap with 1 partition	4 drawers	Top: 2 drawers Bottom: 2 flaps	Top: 2 drawers Bottom: 1 drawer, 1 flap		
as illustr. v. versa	31741	31748	32141	32148	32441	32448	324471 324472		
Price gr. I II	-	-	-	-	-	-	-	-	-
NEW Drawer for end unit optionally left (L) and/or right (R)	391L	392R	391L	392R	391L	392R			
NEW Hinge-door for end unit optionally left (L) and/or right (R)	381L	382R	381L	382R	381L	382R			
Metal substructure 19.4 cm high; High-gloss chrome The units can be planned optionally on a metal substructure. In this case the plinth adjusters are omitted.	 2141		 2171		 2211				
		-	-	-	-	-	-	-	-

4 Raster sideboards with rounded end at both sides

4 Raster sideboards with rounded end at both sides
71.4 cm high
(73.2 cm high incl. 1.8 cm high plinth adjusters),
45.0 cm deep

Wall units or wall assembly, standard interior fittings:
Please see here the information on pages 3-4

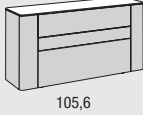
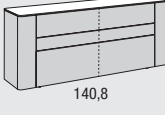
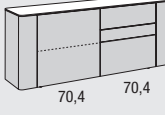
4 Raster sideboards with rounded end at both sides						
	 105,6 140.8 cm wide	 140,8 176.0 cm wide	 70,4 70,4 176.0 cm wide			
Flap hinge at bottom	3 drawers	Top/Centre: 2 drawers Bottom: 1 flap	3 drawers with split drawer frames	Top/Centre: 2 drawers with split drawer frames Bottom: 1 flap with 1 partition	Left: 1 door Right: 3 drawers	Left: 1 door Top right/Centre: 2 drawers Bottom right: 1 flap
as illustr. v. versa	41431	41438	41731	41738	417511 417512	417581 417582
Price gr. I II	-	-	-	-	-	-

NEW
NEW

Drawer for end unit
optionally left (L) and/or right (R)

	491L	492R	491L	492R	491L	492R
	-	-	-	-	-	-

Hinge-door for end unit
optionally left (L) and/or right (R)

	481L	482R	481L	482R	481L	482R
	-	-	-	-	-	-



Wall bracket
If units are planned as wall units, a wall bracket must be ordered.
Max. load: 40 kg

	2105	2145	2145	2145		
	-	-	-	-		

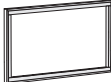

Functional frame for floor units
The units can be planned optionally with a functional frame for floor units.

Functional frame for wall assembly
If you plan a functional frame for wall assembly, you require an extra wall bracket. In this case the plinth adjusters are omitted.
Max. load: 40 kg

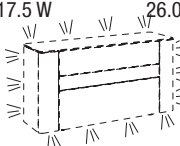
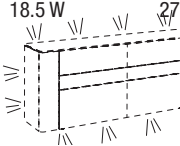
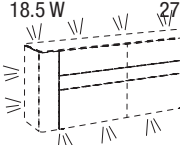
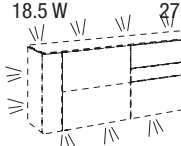
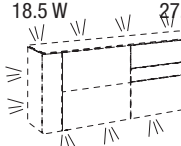

Please note the further information on functional frames on page 5.

						
	Functional frame for floor units	Functional frame for wall assembly	Functional frame for floor units	Functional frame for wall assembly	Functional frame for floor units	Functional frame for wall assembly
	4102	4103	4142	4143	4142	4143
	-	-	-	-	-	-

Lamp for functional frame
The functional frame can be fitted with an optional LED lamp. LED lamp incl. footswitch. Lamp switch optionally with a remote control unit (against surcharge; see page 40). Later fitting not possible.
This luminaire contains built-in LED lamps of the energy classes A++ to A. The lamps cannot be changed in the luminaire. 12 V







	 17.5 W	 26.0 W	 18.5 W	 27.0 W	 18.5 W	 27.0 W
	4104	4144	4144	4144	4144	4144
	-	-	-	-	-	-

Metal substructure
19.4 cm high;
High-gloss chrome
The units can be planned optionally on a metal substructure. In this case the plinth adjusters are omitted.

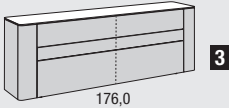
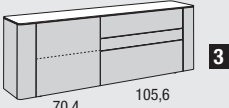
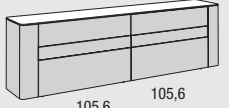
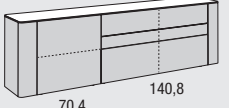
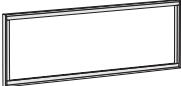
						
	2101	2141	2141			
	-	-	-			

Notes on delivery:
Please see here the information on range introduction pages.

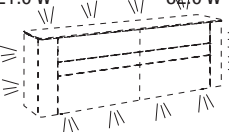
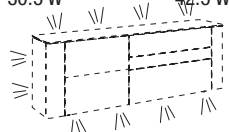
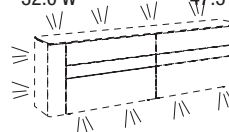
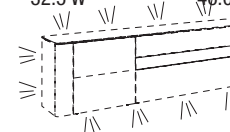
Assembly notes for wall units:
Please be sure to note here the information and notes in the "Wall composition" chapter!

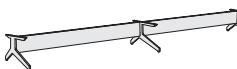
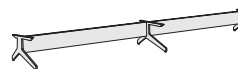
4 Raster sideboards with rounded end at both sides									
									
		211.2 cm wide		211.2 cm wide		246.4 cm wide		246.4 cm wide	
Flap hinge at bottom	3 drawers with split drawer frames	Top/Centre: 2 drawers with split drawer frames Bottom: 1 flap with 1 partition	Left: 1 door Right: 3 drawers	Left: 1 door Top right/Centre: 2 drawers Bottom right: 1 flap	6 drawers	Top/Centre: 4 drawers Bottom: 2 flaps	Top/Centre: 4 drawers Bottom left: 1 drawer Bottom right: 1 flap	Left: 1 door Right: 3 drawers with split drawer frames	Left: 1 door Top right/Centre: 2 drawers with split drawer frames Bottom right: 1 flap with 1 partition
as illustr. v. versa	42131	42138	421511 421512	421581 421582	42431	42438	424371 424372	424511 424512	424581 424582
Price gr.	-	-	-	-	-	-	-	-	-
	491L	492R	491L	492R	491L	492R	491L	492R	492R
	-	-	-	-	-	-	-	-	-
	481L	482R	481L	482R	481L	482R	481L	482R	482R
	-	-	-	-	-	-	-	-	-
	2175		2175		2215		2215		
	-		-		-		-		
									
	Functional frame for floor units	Functional frame for wall assembly	Functional frame for floor units	Functional frame for wall assembly	Functional frame for floor units	Functional frame for wall assembly	Functional frame for floor units	Functional frame for wall assembly	Functional frame for wall assembly
	4172	4173	4172	4173	4212	4213	4212	4213	4213
	-	-	-	-	-	-	-	-	-
	21.0 W	32.0 W	30.5 W	42.5 W	32.0 W	47.5 W	32.5 W	46.0 W	46.0 W
									
	4174	4174	4174	4174	4214	4214	4214	4214	4214
	-	-	-	-	-	-	-	-	-
									
	2171	2171	2171	2171	2211	2211	2211	2211	2211
	-	-	-	-	-	-	-	-	-

4 Raster room-divider sideboards with rounded end at both sides

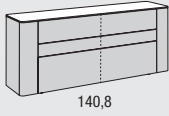
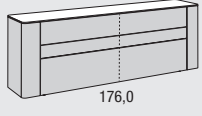
<p>4 Raster room divider sideboards with rounded end at both sides 71.4 cm high (73.2 cm high incl. 1.8 cm high plinth adjusters), 45.0 cm deep</p> <p>Standard interior fittings: See here the information on page 3</p> <p>Note on room divider units: Rear view same as front view (front divisions).</p>		4 Raster room-divider sideboards with rounded end at both sides				
		 140,8 176.0 cm wide		 176,0 211.2 cm wide		
	Flap hinge at bottom	3 drawers with split drawer frames	Top/Centre: 2 drawers with split drawer frames Bottom: 1 flap with 1 partition	3 drawers with split drawer frames	Top/Centre: 2 drawers with split drawer frames Bottom: 1 flap with 1 partition	
	Price gr. I II	41741	41748	42141	42148	

NEW

Drawer for end unit
optionally left (L) and/or right (R)

491L

492R

491L

492R

-

-

-

-

NEW

Hinge-door for end unit
optionally left (L) and/or right (R)

481L

482R

481L

482R

-

-

-

-

Metal substructure
19.4 cm high;
High-gloss chrome

The units can be planned optionally on a metal substructure. In this case the plinth adjusters are omitted.



2141

-





2171

-

Notes on delivery:
Please see here the information on range introduction pages.

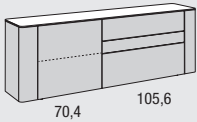
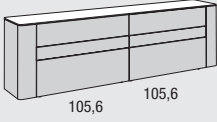
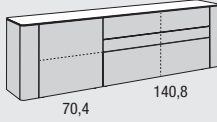

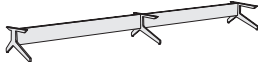
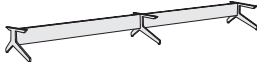
1
2

4 Raster room-divider sideboards with rounded end at both sides									
		 <p>70,4 105,6 211.2 cm wide</p>		 <p>105,6 105,6 246.4 cm wide</p>			 <p>70,4 140,8 246.4 cm wide</p>		
	Flap hinge at bottom	Left: 1 door Right: 3 drawers	Left: 1 door Top right/Centre: 2 drawers Bottom right: 1 flap	6 drawers	Top/Centre: 4 drawers Bottom: 2 flaps	Top/Centre: 4 drawers Bottom left: 1 drawer Bottom right: 1 flap	Left: 1 door Right: 3 drawers with split drawer frames	Left: 1 door Top right/Centre: 2 drawers with split drawer frames Bottom right: 1 flap with 1 partition	
	as illustr. v. versa	421611 421612	421681 421682	42441	42448	424471 424472	424611 424612	424681 424682	
	Price gr.	- -	- -	- -	- -	- -	- -	- -	
		491L	492R	491L	492R	491L	492R	492R	
		-	-	-	-	-	-	-	
		481L	482R	481L	482R	481L	482R	482R	
		-	-	-	-	-	-	-	
									
		2171		2211			2211		
		-		-			-		

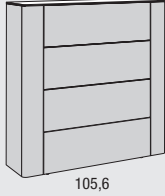
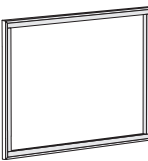
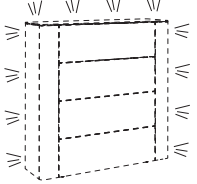
8 Raster highboard with rounded end at both sides

8 Raster highboard with rounded end at both sides 141.8 cm high (143.6 cm high incl. 1.8 cm high plinth adjusters), 45.0 cm deep Cannot be fitted as a wall unit!	8 Raster highboard with rounded end at both sides				
	 105,6 140.8 cm wide				
	Flap hinge at bottom	4 drawers	Top: 1 flap Bottom: 3 drawers	Top: 2 flaps Bottom: 2 drawers	Top: 3 flaps Bottom: 1 drawer
	Price gr.	81411	81418	81417	81416
	-	-	-	-	
NEW Drawer for end unit optionally left (L) and/or right (R)		891L		892R	
		-		-	
NEW Hinge-door for end unit optionally left (L) and/or right (R)		881L		882R	
		-		-	
Functional frame for floor units The units can be planned optionally with a functional frame for floor units. Please note the further information on functional frames on page 5.					
	Functional frame for floor units				
	8102 - 26.0 W				
Lamp for functional frame The functional frame can be fitted with an optional LED lamp. LED lamp incl. footswitch. Lamp switch optionally with a remote control unit (against surcharge; see page 40). Later fitting not possible. This luminaire contains built-in LED lamps of the energy classes A++ to A. The lamps cannot be changed in the luminaire. 12 V					
	8104 -				

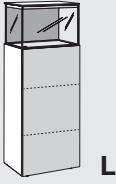
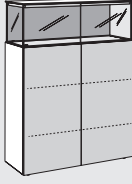
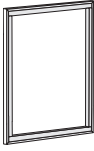
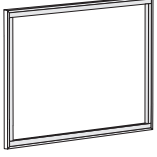
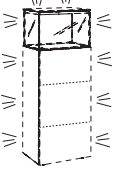
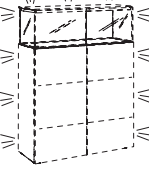
8 Raster cabinets

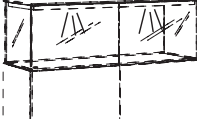
<p>8 Raster cabinets 141.8 cm high (143.6 cm high incl. 1.8 cm high plinth adjusters), 45.0 cm deep</p> <p>Standard interior fittings and notes on cabinets: Please see here the information on pages 3-4</p> <p>Cannot be fitted as a wall unit!</p>	8 Raster cabinets	
	 <p>52.8 cm wide</p> <p>1 door with glass panel</p>	 <p>105.6 cm wide</p> <p>2 doors with glass panel</p>
	<p>85141 L 85142 R</p> <p>Price gr. I II</p> <p>-</p>	<p>81014</p> <p>-</p>
<p>Functional frame for floor units The units can be planned optionally with a functional frame for floor units.</p> <p>Please note the further information on functional frames on page 5.</p>	 <p>Functional frame for floor units</p>	 <p>Functional frame for floor units</p>
	<p>852</p> <p>-</p> <p>21.5 W</p>	<p>8102</p> <p>-</p> <p>25.5 W</p>
	 <p>854</p> <p>-</p>	 <p>8104</p> <p>-</p>
<p>Integrated LED spotlamps for cabinets Ø 7.1 cm The cabinets can be fitted with optional integrated LED spotlamps. Integrated LED spotlamps incl. footswitch. Lamp switch optionally with a remote control unit (against surcharge; see page 40).</p> <p>This luminaire contains built-in LED lamps of the energy classes A++ to A. The lamps cannot be changed in the luminaire. 12 V</p> <p>Note: For type 81014 2 integrated LED spotlamps must be ordered!</p>	<p>2.9 W</p>  <p>7941</p> <p>-</p>	<p>2x 2.9 W</p>  <p>For type 81014 2 integrated LED spotlamps must be ordered!</p> <p>2x 7941</p> <p>2x -</p>

12 Raster cabinets

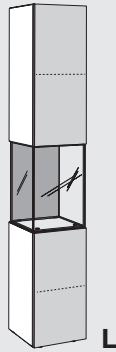
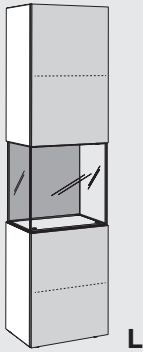
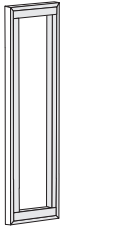
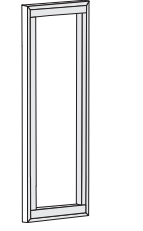
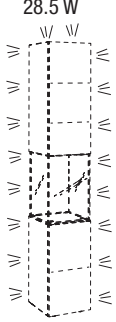
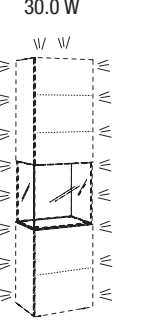
<p>12 Raster cabinets 211.2 cm high (213.0 cm high incl. 1.8 cm high plinth adjusters), 45.0 cm deep</p> <p>Standard interior fittings and notes on cabinets: Please see here the information on pages 3-4</p> <p>Cannot be fitted as a wall unit!</p>	12 Raster cabinets	
<p>Functional frame for floor units The units can be planned optionally with a functional frame for floor units.</p> <p>Please note the further information on functional frames on page 5.</p>	 <p>35.2 cm wide</p> <p>1 door with glass panel</p>	 <p>52.8 cm wide</p> <p>1 door with glass panel</p>
<p>Lamp for functional frame The functional frame can be fitted with an optional LED lamp. LED lamp incl. footswitch. Lamp switch optionally with a remote control unit (against surcharge; see page 40). Later fitting not possible.</p> <p>This luminaire contains built-in LED lamps of the energy classes A++ to A. The lamps cannot be changed in the luminaire. 12 V</p>	<p>123141 L 123142 R</p> <p>Price gr. I - II -</p>	<p>125141 L 125142 R</p> <p>Price gr. I - II -</p>
<p>Integrated LED spotlamps for cabinets Ø 7.1 cm The cabinets can be fitted with optional integrated LED spotlamps. Integrated LED spotlamps incl. footswitch. Lamp switch optionally with a remote control unit (against surcharge; see page 40).</p> <p>This luminaire contains built-in LED lamps of the energy classes A++ to A. The lamps cannot be changed in the luminaire. 12 V</p>	 <p>28.5 W</p> <p>1232</p>	 <p>30.0 W</p> <p>1252</p>
	 <p>2.9 W</p> <p>7941</p>	 <p>2.9 W</p> <p>7941</p>

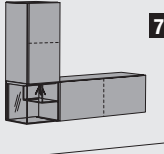
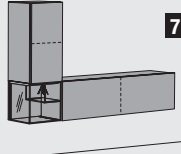
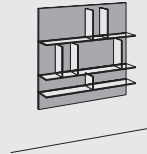
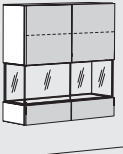
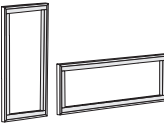
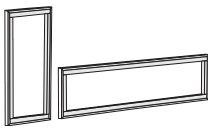
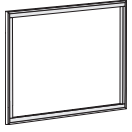
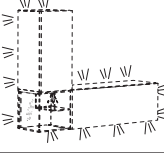
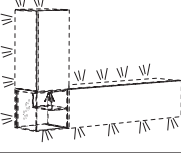
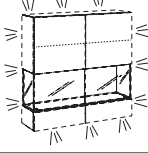
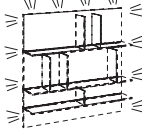
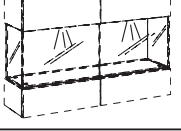

6 Raster wall units

<p>6 Raster wall units 105.6 cm high 33.0 cm deep incl. integrated LED spotlamp in open glass compartment; a remote control is essential for operation (against surcharge)</p> <p>6 Raster wall shelf 105.6 cm high 26.2 cm deep</p> <p>6 Raster wall cabinet 105.6 cm high 33.0 cm deep</p> <p>Notes on wall units: Please see here the information on page 4</p> <p>Max. load wall shelf and wall cabinet: 20 kg Max. load wall units: 40 kg</p>		<p>6 Raster wall unit</p>  <p>140.8 cm wide</p> <p>1 door; 1 flap; 1 open glass compartment</p>	<p>6 Raster wall unit</p>  <p>176.0 cm wide</p> <p>1 door; 1 flap; 1 open glass compartment</p>	<p>6 Raster wall shelf</p>  <p>105.6 cm wide</p> <p>3 glass shelves, 6 glass partitions</p>	<p>6 Raster wall cabinet</p>  <p>105.6 cm wide</p> <p>2 doors with glass panel</p>
<p>Functional frame for wall assembly If you plan a functional frame for wall assembly for the 6 Raster wall cabinet and wall units, you do not require an extra wall bracket.</p> <p>Max. load: 20 kg</p> <p>Please note the further information on functional frames on page 5.</p>		 <p>Functional frame for wall assembly</p>	 <p>Functional frame for wall assembly</p>		 <p>Functional frame for wall assembly</p>
<p>Lamp for functional frame The functional frame can be fitted with an optional LED lamp. LED lamp incl. footswitch. Lamp switch optionally with a remote control unit (against surcharge; see page 40). Later fitting not possible.</p> <p>This luminaire contains built-in LED lamps of the energy classes A++ to A. The lamps cannot be changed in the luminaire. 12 V</p>		<p>40.5 W</p>  <p>6144</p>	<p>43.5 W</p>  <p>6174</p>		<p>27.5 W</p>  <p>6104</p>
<p>Lamp for wall shelf The wall shelf can be fitted with an optional LED lamp. LED lamp incl. footswitch. Lamp switch optionally with a remote control unit (against surcharge; see page 40).</p> <p>This luminaire contains built-in LED lamps of the energy classes A++ to A. The lamps cannot be changed in the luminaire. 12 V</p>				<p>30.0 W</p>  <p>6114</p>	
<p>Integrated LED spotlamps for wall cabinet Ø 7.1 cm The cabinet can be fitted with optional integrated LED spotlamps. Integrated LED spotlamps incl. footswitch. Lamp switch optionally with a remote control unit (against surcharge; see page 40).</p> <p>This luminaire contains built-in LED lamps of the energy classes A++ to A. The lamps cannot be changed in the luminaire. 12 V</p> <p>Note: For type 61014 2 integrated LED spotlamps must be ordered!</p>					<p>2x 2.9 W</p>  <p>2x 7941 2x -</p>

Accent units

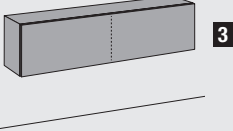
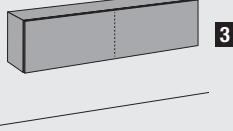
Wall units

<p>2 Raster wall accent units 35.2 cm high (in leather version: 36.8 cm); 33.0 cm deep</p> <p>Notes on accent units: Carcase and front also in the versions knotted oak, knotted oak anthracite, knotted core walnut, Nappa leather, saddle leather and Nubuk-Touch leather possible. The inside carcasse of accent units in leather version is in matt grey lacquer. If accent units are required in a leather version, the unit width increases by 1.6 cm.</p> <p>Wall units or wall assembly: Please see here the information on pages 3-4</p>	2 Raster wall accent units				
	 <p>105.6 cm wide (in leather version: 107.2 cm)</p>		 <p>140.8 cm wide (in leather version: 142.4 cm)</p>		
	1 flap with 1 partition (flap hinge at bottom)	1 flap with 1 partition (flap hinge at top)	1 flap with 1 partition (flap hinge at bottom)	1 flap with 1 partition (flap hinge at top)	
	2108	2109	2148	2149	
Price gr. I II III IV	-	-	-	-	-

<p>Functional frame for wall assembly If you plan a functional frame for wall assembly for the wall accent units, you do not require an extra wall bracket.</p> <p>Max. load: 20 kg</p> <p>Please note the further information on functional frames on page 5.</p>				
	Functional frame for wall assembly		Functional frame for wall assembly	
	2106 -	2146 -		

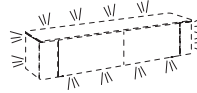
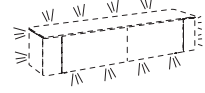
<p>Lamp for functional frame The functional frame can be fitted with an optional LED lamp. LED lamp incl. footswitch. Lamp switch optionally with a remote control unit (against surcharge; see page 40). Later fitting not possible.</p> <p>This luminaire contains built-in LED lamps of the energy classes A++ to A. The lamps cannot be changed in the luminaire. 12 V</p>	19.5 W	22.5 W	
	 <p>2104 -</p>	 <p>2144 -</p>	

2 Raster wall accent units

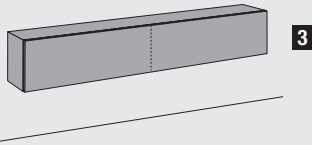

176.0 cm wide
(in leather version: 177.6 cm)

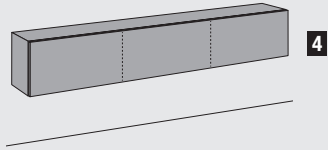

211.2 cm wide
(in leather version: 212.8 cm)

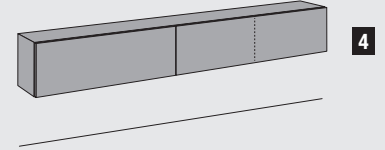

246.4 cm wide
(in leather version: 248,0 cm)

1 flap with 1 partition (flap hinge at bottom)

1 flap with 1 partition (flap hinge at top)

1 flap (flap hinge at bottom); for veneered/lacquered versions with 2 partitions and 4 wall mounting points, for knotted and leather versions with 1 partition and 3 wall mounting points

1 flap (flap hinge at top); for veneered/lacquered versions with 2 partitions and 4 wall mounting points, for knotted and leather versions with 1 partition and 3 wall mounting points

2 flaps (wide flap with 1 partition; flap hinge at bottom)

2 flaps (wide flap with 1 partition; flap hinge at top)

as illustr.
v. versa
Price gr.
I
II
III
IV

2178

2179

2218

2219

24681
24682

24691
24692



Functional frame for wall assembly

2176

-

27.5 W

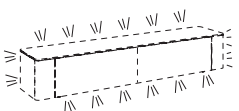

2174

-



Functional frame for wall assembly

2216

-

30.0 W

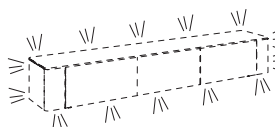

2214

-



Functional frame for wall assembly

2246

-

35.5 W

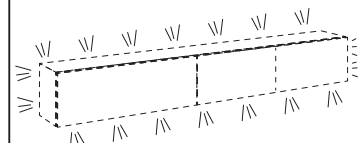

2244



-

Accent units





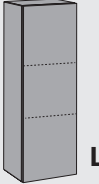
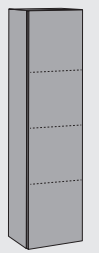
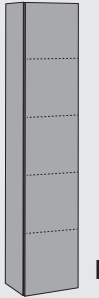
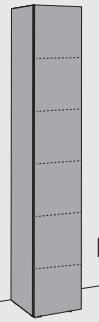

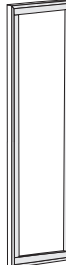
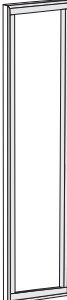
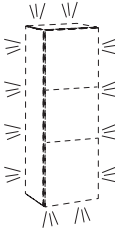
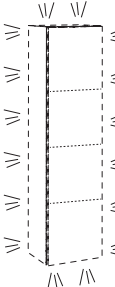
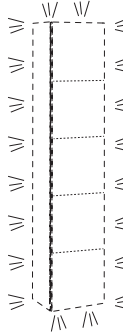
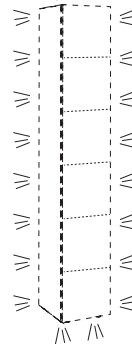
Wall units and floor unit

Assembly notes for wall units:
Please be sure to note here the information and notes in the "Wall composition" chapter!

3
4

<p>6 Raster wall accent unit 105.6 cm high (in leather version: 107.2 cm); 33.0 cm deep</p> <p>8 Raster wall accent unit 140.8 cm high (in leather version: 142.4 cm); 33.0 cm deep</p> <p>10 Raster wall accent unit 176.0 cm high (in leather version: 177.6 cm); 33.0 cm deep</p> <p>12 Raster floor accent unit 211.2 cm high (in leather version: 214.6 cm); 213.0 cm high incl. 1.8 cm high plinth adjusters); 45.0 cm deep</p> <p>Notes on accent units: Carcase and front also in the versions knotted oak, knotted oak anthracite, knotted core walnut, Nappa leather, saddle leather and Nubuk-Touch leather possible. The inside carcass of accent units in leather version is in matt grey lacquer. If accent units are required in a leather version, the unit width increases by 1.6 cm.</p> <p>Wall units or wall assembly: Please see here the information on pages 3-4</p>		<p>6 Raster wall accent unit</p>  <p>35.2 cm wide (in leather version: 36.8 cm)</p> <p>1 door; 2 fitted shelves</p>	<p>8 Raster wall accent unit</p>  <p>35.2 cm wide (in leather version: 36.8 cm)</p> <p>1 door; 3 fitted shelves</p>	<p>10 Raster wall accent unit</p>  <p>35.2 cm wide (in leather version: 36.8 cm)</p> <p>1 door; 4 fitted shelves</p>	<p>12 Raster floor accent unit</p>  <p>35.2 cm wide (in leather version: 36.8 cm)</p> <p>1 door; 5 fitted shelves</p>
<p>Functional frame for wall assembly If you plan a functional frame for wall assembly for the wall accent units, you do not require an extra wall bracket.</p> <p>Max. load: 20 kg</p> <p>Functional frame for floor units The units can be planned optionally with a functional frame for floor units.</p> <p>Please note the further information on functional frames on page 5.</p>		 <p>Functional frame for wall assembly</p>	 <p>Functional frame for wall assembly</p>	 <p>Functional frame for wall assembly</p>	 <p>Functional frame for floor units</p>
<p>Lamp for functional frame The functional frame can be fitted with an optional LED lamp. LED lamp incl. footswitch. Lamp switch optionally with a remote control unit (against surcharge; see page 40). Later fitting not possible.</p> <p>This luminaire contains built-in LED lamps of the energy classes A++ to A. The lamps cannot be changed in the luminaire. 12 V</p>	<p>Price gr.</p> <p>I</p> <p>II</p> <p>III</p> <p>IV</p>	<p>632311 L 632312 R</p> <p>-</p> <p>-</p> <p>-</p> <p>-</p>	<p>832311 L 832312 R</p> <p>-</p> <p>-</p> <p>-</p> <p>-</p>	<p>1032311 L 1032312 R</p> <p>-</p> <p>-</p> <p>-</p> <p>-</p>	<p>123211 L 123212 R</p> <p>-</p> <p>-</p> <p>-</p> <p>-</p>
		<p>19.5 W</p> 	<p>22.5 W</p> 	<p>27.5 W</p> 	<p>38.5 W</p> 
		<p>634</p> <p>-</p>	<p>834</p> <p>-</p>	<p>1034</p> <p>-</p>	<p>1234</p> <p>-</p>

Accessories for drawers

		for 52.4 cm front width	for 70.4 cm front width	for 105.6 cm front width	for ½ drawer, 140.8 cm wide	for ½ drawer, 176.0 cm wide
 <p>Tableau lined with grey fabric</p>	for 45.0 cm depth	8625 -	8626 -	8627 -	8626 -	8632 -
 <p>CD holder for drawers Please state exactly in your order and drawing in which 2 Raster drawer the CD holder is to be fitted.</p>	for 45.0 cm depth	8425 -	8426 -	8427 -	8426 -	8432 -
		for 48 CD's	for 64 CD's	for 112 CD's	for 64 CD's	for 96 CD's
 <p>DVD/Blu-Ray holder for drawers Please state exactly in your order and drawing in which 2 Raster drawer the DVD/Blu-Ray holder is to be fitted.</p>	for 45.0 cm depth	8325 -	8326 -	8327 -	8326 -	8332 -
		for 22 DVD's	for 33 DVD's	for 44 DVD's	for 33 DVD's	for 44 DVD's
  <p>Cutlery box of metal, lined with grey fabric inside; incl. compartments</p>			17.6 cm wide		35.2 cm wide	
				855 -	856 -	
 <p>Cutlery holder lined with grey fabric, for fitting in drawers</p> <p>Set 1: for 60 pieces of cutlery Set 2: for 17 serving utensils</p>			Set 1: for standard cutlery like spoons, forks, knives, etc.		Set 2: for sauce ladles, cake forks, cake servers, etc.	
				116 -	117 -	

Accessories for units

Fitted shelves

 Fitted shelf 1.9 cm thick			in 35.2 cm wide carcasses resp. behind 34.8 cm wide doors	behind 52.4 cm wide doors and flaps	behind 70.4 cm wide doors and flaps	behind 105.6 cm wide flaps	for ½ compartment behind 140.8 cm wide flaps	for ½ compartment behind 176.0 cm wide flaps	
	for 33.0 cm depth	Price gr. I II	133 - -						
	for 45.0 cm depth	Price gr. I II	134 - -	154 - -	174 - -	1104 - -	174 - -	184 - -	

Lamps

<p>This luminaire contains built-in LED lamps of the energy classes A++ to A. The lamps cannot be changed in the luminaire. 12 V</p>	<p>LED lamps incl. foot switch. A radio remote control is possible for operation (against a surcharge).</p>
 <p>Integrated LED spotlight Ø 7.1 cm; for fitting in units</p> <p>Later fitting is not possible.</p>	<p>2.9 W</p> <p>7941 -</p>

NEW

Radio remote control with change of colour temperature

The lamps are normally operated by an external foot switch. The colour temperature of the LED lamps is cold white if a foot switch is used. A 4-channel radio remote control is also available as an alternative, which is charged extra. Several lamps can be operated with each of the 4 channels. All 4 channels can be dimmed separately at the push of a button. The colour temperature of all 4 channels can be set to any level from cold white (approx. 6500 kelvin = the basic setting of the LED lamps) to warm white (approx. 2700 kelvin). If warm white is required, a radio remote control must be ordered. It is also possible to switch all channels on and off simultaneously with the "all on" or "all off" buttons. The radio remote control consists of one transmitter and one receiver. If several receivers are required because of the arrangement of the units, these and the corresponding cables are provided ex-works (no surcharge). The foot switch is omitted when the radio remote control is used.



2119
-

DINING

hülsta offers a room concept to meet all requirements in comfort, beauty of form and attractiveness with a comprehensive collection of dining room tables and chairs.

The **dining tables** in a wide variety of sizes (with and without pullout function) in all wood surface versions and in contemporary designs, as well as the **dining chairs** that can be combined individually using different armrests, comfort features, high-grade cover fabrics (leather, textiles) and metal surfaces can all be found in the **"DINING"** type list.



Coffee tables CT 160

Coffee tables CT 160

The **CT 160 coffee table** in sizes of 80 x 80 cm and 110 x 80 cm offers three different plinth versions. The bottom shelf is veneered, lacquered or in knotted wood, the top section is of glass, in one of four optional glass versions.

You will find the coffee table CT 160 as well as other coffee tables in the **"Coffee tables"** type list.



Coffee tables

Coffee tables

hülsta offers a comprehensive **collection of coffee tables**, which not only match the hülsta furniture ranges perfectly but can also be combined with other products that are available on the market. You will find these coffee tables in a number of designs, sizes and versions in the **"Coffee tables"** type list.



Cable apertures

It is possible to provide the cover shelves, side sections, shelves, etc., in units from nearly all the hülsta living room ranges with cable apertures so it is easier to feed cables of electronic equipment through these units. There are four different types of cable apertures to choose from, as listed here. **Please be sure to follow the important notes.**

Cable aperture K1

Cable aperture for 80 mm hole, silver colour
Standard cable aperture; particularly suitable for cover shelves, side sections and shelves

Sizes:
Assembly height: 21 mm
Outside diameter: 92 mm
Inside diameter: 74 mm
Diameter of hole: 80 mm

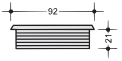

K1

Cable aperture K2

Cable aperture for 80 mm hole, silver colour
particularly suitable for rear walls and side sections

Sizes:
Assembly height: 8 mm
Outside diameter: 92 mm
Inside diameter: 74 mm
Diameter of hole: 80 mm

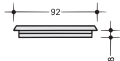

K2

Cable aperture K3

Cable aperture for 60 mm hole, silver colour
particularly suitable for shelves and constructional shelves (suitable to an extent for scart cables)

Sizes:
Assembly height: 21 mm
Outside diameter: 72 mm
Inside diameter: 54 mm
Diameter of hole: 60 mm

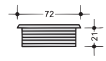

K3

Cable aperture K20

Cable aperture for 80 mm hole, silver colour
particularly suitable for side-panels and centre partitions

Sizes:
Assembly height: 2x 8 mm
Outside diameter: 92 mm
Inside diameter: 74 mm
Diameter of hole: 80 mm

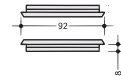

K20

IMPORTANT NOTES Please be sure to note!

Please be sure to state the **exact position** of the cable aperture in your order (always measure distances from the centre of the cable aperture). For **wall units** the cable aperture is only possible in the bottom position (due to the suspension brackets). With **cover shelves**, the position of the cable aperture is determined in the factory, in accordance with factors specific to the given range. The same applies to technical exceptions because of custom-based planning. The K 20 is positioned in the centre (depthwise) in the **side-panel**. Please state the exact height (centre of hole of cable aperture from bottom rim of side-panel)! Subject to technical progress.

The **minimum distance** for the cable aperture (measured from the inside): 100 mm from the side and 70 mm from the rear (for horizontal surfaces) or 100 mm from the side and 70 mm from the base (for vertical surfaces). Please state if the aperture is to be fitted at the left, at the right or in the centre.

Standard position: If no details of the exact position of the cable aperture are given in your order, the cable aperture is always fitted at the bottom centre or at the rear centre of the relevant surface, whereby the distances stated above still apply.

Caution! Please note that the cable aperture can not be fitted where there is an integrated or front spotlight, centre partitions or a split rear wall. **Please be sure to observe the following explanatory diagrams!**

for vertical surfaces

for horizontal surfaces

Minimum distance

100 mm from the side and 70 mm from the base

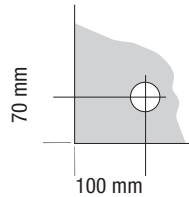
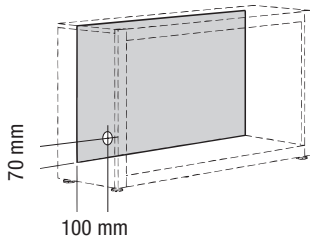

Minimum distance

100 mm from the side and 70 mm from the rear

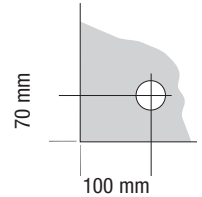
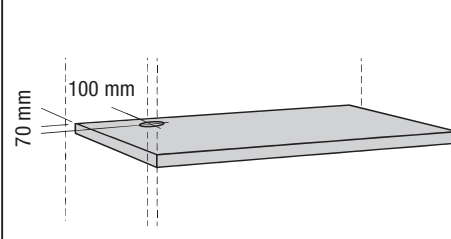

Standard position

at the centre of the surface and 70 mm from the base

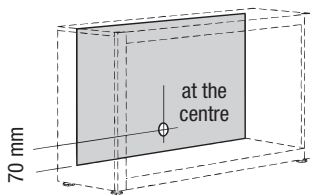

Standard position

at the centre of the surface and 70 mm from the rear

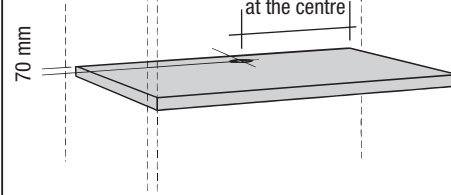

Please note!

If there is an integrated or front spotlight in a shelf, for example, the cable aperture cannot be fitted at this position!

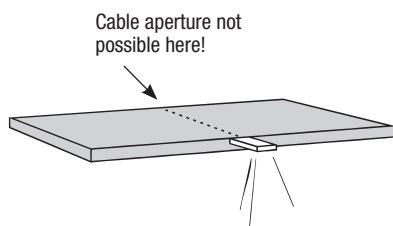

Please note!

If there is a centre partition, for example, between two shelves, the cable aperture cannot be fitted at this position!

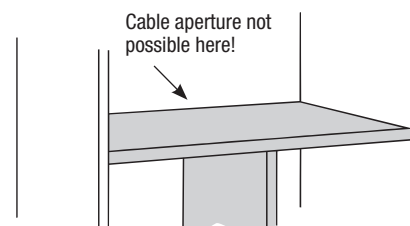

GENTIS

Special-sized products are possible on request.
Please get in touch with your customer advisor.

Special articles

Cover panels

for side and top panelling of fitted wardrobes (support construction and fitting materials must be acquired on site).

Basic price per order	9901	-
+ price per m ² in price group I	990	-
+ price per m ² in price group II	990	-

Veneer match with fronts can not be guaranteed.

High-gloss care set

Polish, polishing sponge and polishing cloth (incl. instructions) for protecting and maintaining the high-gloss surfaces

36 -

Individual special-sized products

If the special-sized product that you require is so unusual that it cannot be illustrated with the many special sized products that we already provide and charge for, then we will quote you the price using a HK unit type factor. In your order please state for us the relevant enquiry number and the HK unit type factor stated.

HK -

Special colours; Note on „Blue Angel“ / Emissions label of DGM

Special colours

All the hülsta lacquer colours are possible for nearly all the hülsta ranges. Availability and prices on request.

Note on „Blue Angel“ (RAL-UZ 38) and Emissions label of DGM (Class A)

It is possible that the requirements of the „Blue Angel“ and the DGM Emissions Label cannot be met by some of the lacquer colours in price groups II and III (see here the different lacquer versions in the NURIA range), depending on the colour mix (surface ratio of these colours in the corresponding order). However, the legal requirements are definitely met in all cases!

Switch options for lamps: Radio remote control with change of colour temperature

Radio remote control with change of colour temperature

The lamps are normally operated by an external foot switch. The colour temperature of the LED lamps is cold white if a foot switch is used. A 4-channel radio remote control is also available as an alternative, which is charged extra. Several lamps can be operated with each of the 4 channels. All 4 channels can be dimmed separately at the push of a button. The colour temperature of all 4 channels can be set to any level from cold white (approx. 6500 kelvin = the basic setting of the LED lamps) to warm white (approx. 2700 kelvin). If warm white is required, a radio remote control must be ordered. It is also possible to switch all channels on and off simultaneously with the "all on" or "all off" buttons. The radio remote control consists of one transmitter and one receiver. If several receivers are required because of the arrangement of the units, these and the corresponding cables are provided ex-works (no surcharge). The foot switch is omitted when the radio remote control is used.

The following points must be noted with the radio remote control:

- The receiver must be positioned behind a rear wall or under plinth shelves (at least 20 mm space required under plinth shelves).
- The total wattage power of all lamps included per receiver must not exceed 30 W.
- 4 channels = 4 light groups
- 1 light group = x lights
- All lamps within a light group can be dimmed to the same brightness.
- The change of the colour temperature takes place for all lamps in all light groups.
- The radio remote control is not suitable for equipment operating on 110 V.

Please be sure to note the operating and programming instructions!

4-channel radio remote control with change of color temperature

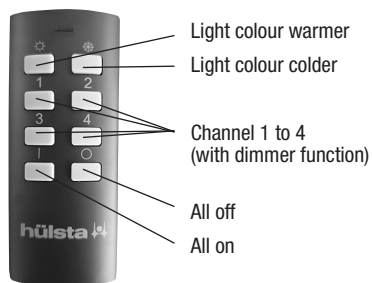

4-channel radio remote control with change of color temperature

Type	2119	-
------	------	---

Examples of use (schematic diagrams)

Example 1

Lights inside a unit

Channel 1 operates (and dims) all the lights in light group 1, i.e. the LED spotlamp in the left cabinet

Channel 2 operates (and dims) all the lights in light group 2, i.e. the LED spotlamps in the open compartment

Channel 3 operates (and dims) all the lights in light group 3, i.e. the LED spotlamp in the right cabinet

Notes:

The total wattage power of all lamps included per receiver must not exceed 30 W. The change of the colour temperature takes place for all lamps in all light groups.

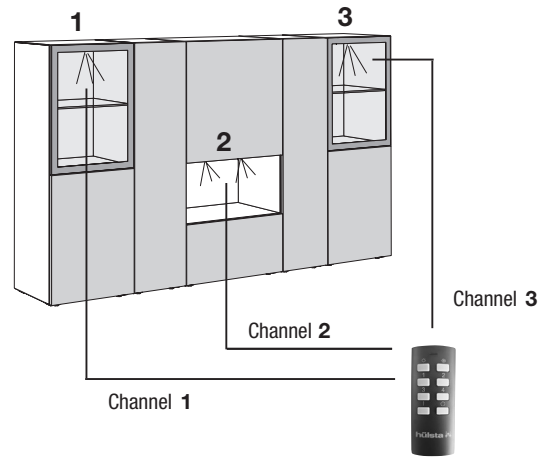

Example 2

Lights in units set apart

Channel 1 operates (and dims) all the lights in light group 1, i.e. the LED spotlamp and the LED light panels in the left cabinet

Channel 2 operates (and dims) all the lights in light group 2, i.e. the LED spotlamps and the LED light panels in the centre cabinet

Channel 3 operates (and dims) all the lights in light group 3, i.e. the LED spotlamp and the LED light panels in the right cabinet

Notes:

The total wattage power of all lamps included per receiver must not exceed 30 W. The change of the colour temperature takes place for all lamps in all light groups.

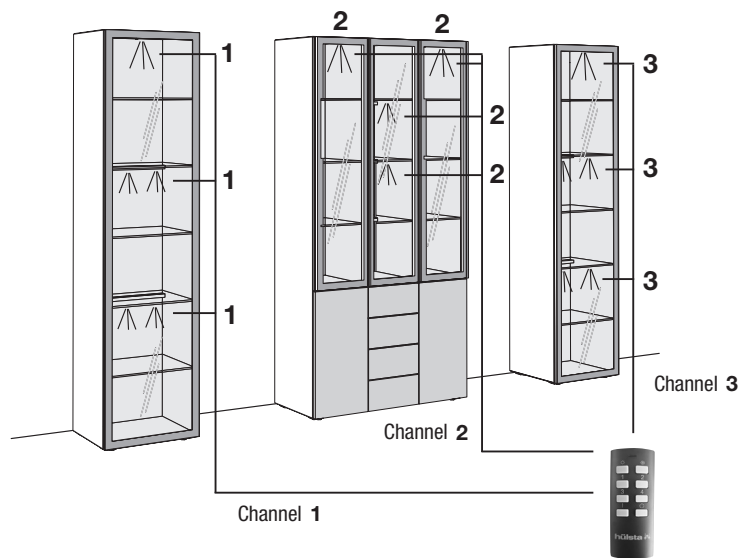

Example 3

Lights in units set apart

Channel 1 operates (and dims) all the lights in light group 1, i.e. the LED spotlamps in the left, centre and right cabinet

Channel 2 operates (and dims) all the lights in light group 2, i.e. the top LED light panels in the left, centre and right cabinet

Channel 3 operates (and dims) all the lights in light group 3, i.e. the bottom LED light panels in the left, centre and right cabinet

Notes:

The total wattage power of all lamps included per receiver must not exceed 30 W. The change of the colour temperature takes place for all lamps in all light groups.

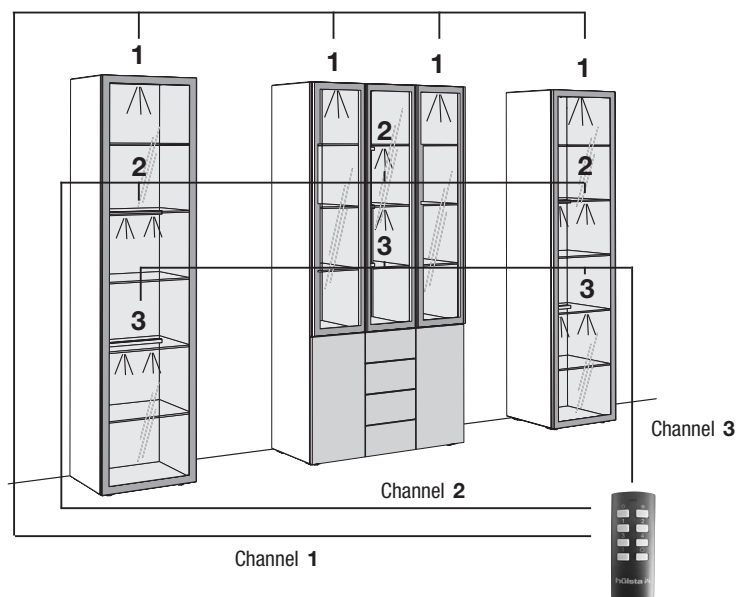

Important notes

Wall composition / assembly instruction

Important notes:

The composition of walls must be ascertained before concluding a contract and be checked by a qualified fitter before assembly takes place.







Assembly may only be carried out by a qualified fitter under careful observation of the assembly instructions.

The plastic Rawl plugs supplied by hülsta as a standard set are only suitable for concrete \geq C12/15, if the wall composition and compression strength corresponds to the table below. Under no circumstances must a unit be assembled on light masonry.

Furthermore, we provide a mounting set with assembly mortar for the types of walls listed below (see assembly mortar set below). Again, assembly must be carried out by a qualified fitter under careful observation of the wall composition and assembly instruction. The compression strength levels stated below must be met under all circumstances.

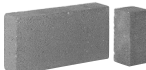
Materials table

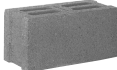
with a description of which sets are to be used with the following types of walls:

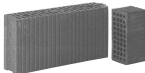
Standard set	Assembly mortar set only suitable for the materials stated below!	
Concrete C12/15 Compression strength \geq 15 N/mm ² 	 Building bricks Mz 12 Compression strength \geq 12 N/mm ²	 Solid blocks of light concrete V2 Compression strength \geq 2 N/mm ²
	 Limestone blocks KS 12 Compression strength \geq 12 N/mm ²	 Perforated blocks of light concrete Hbl 2 Compression strength \geq 2 N/mm ²
	 Perforated sand lime bricks KSL12 Compression strength \geq 12 N/mm ²	 Aerated concrete PP2 Compression strength \geq 2 N/mm ²
	 Vertically perforated bricks HLz 12 Compression strength \geq 12 N/mm ² Bulk density \geq 1.0 kg/dm ³	

A different and more suitable type of mounting must be chosen by a qualified fitter in all other cases. hülsta cannot accept any responsibility for the choice of any other types of mounting! Please note that if the units are not mounted properly on the wall, there is a risk of the units falling down or tipping over – especially when alternative mounting materials acquired on site have been used. Generally speaking, you as a dealer/qualified fitter are responsible for the correct wall mounting of the units.



Mounting sets

Labelling in type list drawings / assembly notes for wall units

The majority of units have two wall mounting points (= number of support boards), if these are to be fitted as wall units. This is not explicitly mentioned in the type list. If a different number of wall mounting points (= support boards) is required, this is marked in the drawings in the type list with numbers in black boxes. Every support board requires four mounting screws.

- 3 = 3 support boards
- 4 = 4 support boards, etc.

One **assembly mortar set** is sufficient for up to a maximum of 3 support boards or 4 wall side-panels.

Important note: Depending on the composition of the wall (see wall types illustrated above), assembly must be carried out using the special assembly mortar set and a standard trade mastic tool which are the basic essentials for safe and clean workmanship.

Standard set

The standard set consists of 4 plastic Rawl plugs and 4 mounting screws and is sufficient for 1 support board. The standard sets are included in the packet of fittings to match the number of support boards.

Assembly mortar set for up to a maximum of 3 support boards consisting of:

- 9x injection retaining sleeve
- 9x screw-in sleeve
- 1x injection cartridge
- 2x static mixer
- 1x assembly instructions

Please use the mounting screws from the standard set (supplied free of charge).

Example of order:

- Add up number of support boards for all existing unit types
 - Divide the sum by “3”
 - Round up the result to a full number
- = Number of assembly mortar sets required

M2

-

Your Hotline to hülsta

Do you have any questions or require any alterations to your order confirmation?
Do you have any questions on our products or your current order?
Do you have any complaints about supplied goods or required replacement parts?
Contact Telephone: +49 (0) 2563 / 86-1627 • email: orders@huelsta.com

Do you have any questions, suggestions or wishes for the **hülsta product seminars**?
Contact Telephone: +49 (0) 2563 / 86-1493 • email: produktschulungen@huelsta.de

hülsta Planning Service

Lots to do? A customer wants his project finished and you haven't got enough time? Or the project is so complex that it will take too much time?

This is exactly the kind of situation we created the hülsta Planning Service for. hülsta's employees create the required project for you at short notice. Based on your information, we implement the project perfectly with all views and a complete order list ready for immediate forwarding to the customer.

The hülsta check list (available at <https://www.huelsta.com/einrichtungsberatung/>) makes it all really easy for you. You won't forget anything with this list and the customer receives a project he will be thrilled about as quickly as possible.

hülsta Planning Service

Tel.: +49 (0) 2563 / 86-1060

Fax: +49 (0) 2563 / 86-1000

Mail: Planungsservice-Handel@huelsta.de

Workdays from 8.00 a.m. until 6.00 p.m.

Special wishes? Come to us!

Maximum individuality! – Maximal flexibility! – hülsta makes most of your special wishes possible.
And if you do have a wish which is not quite so easy to implement, just give us a call or send us a mail or a fax. We have our own hülsta "Special Wishes Team" who are there to help you realise just these customer requests. These colleagues are professionals when it comes to special products. They plan and calculate the products possible for you and even develop an alternative suggestion if the idea should turn out to be technically impossible.

Here is an overview of the hülsta range of special wishes:

- A lot of special products can be ordered simply via the type list
- Special-sized products are planned simply and professionally
- Competent colleagues advise you by phone, by fax and by mail
- You will be sent alternative suggestions if the idea is technically impossible
- Many special-sized products are available without a surcharge
- Specially qualified carpenters and technicians implement your plans perfectly

hülsta Special Wishes Team

Tel.: +49 (0) 2563 / 86-1060

Fax: +49 (0) 2563 / 86-1417

Mail: Sonderwunsch@huelsta.com

We are open Saturdays for you, too!

Our **Saturday hotline** is available at the following times and periods:

- **15th April – 15th September** from **10.00 a.m. until 4.00 p.m.**
- **16th September – 14th April** from **10.00 a.m. until 6.00 p.m.**

Telephone: +49 (0) 2563 / 86-1800

On **working days** the hülsta Sales Department is available all day from **8.00 a.m. until 6.00 p.m.**

hülsta GENTIS Wohnen

Stand: E 12. 2019

Design and concept legally protected, subject to error and alterations to construction, colour and materials by way of technological progress.

hülsta-werke · Karl-Hüls-Straße 1 · D-48703 Stadthoorn
Tel. +49 (0) 2563 / 86-0 · Fax +49 (0) 2563 / 86-1000
www.huelsta.com

