

hülsta 

Die Möbelmarke.

hülsta

5/18

E

www.huelsta.com

Type list

LIVING



FENA LIVING

A perfect fusion of originality and modernity.

Perfect balance provided by striking contrasts – how does that work? Easily. By mixing apparent contrasts. FENA proves that very different and very original materials can be perfectly combined in a balanced design. Accents in concrete grey and natural planked oak team up with elegant matt lacquer to create a monolithic architecture that is both archaic and futuristic. Horizontal lines offer tranquillity, the square provides a balancing counterweight.

Using impressively pure materials and featuring clean and simple lines, FENA offers an utterly stylish fusion of apparent contrasts. Functional units add striking highlights to the living room.

A stunning mix of lacquer, wood and concrete:

Concrete grey accents and rustic planked oak team up with elegant matt lacquer in a balanced furniture architecture – original yet futuristic.

A balanced design:

An emphasis on horizontal lines within a regular geometry ensures a laid-back look – continuous veneer pattern in the fronts.

ROTARY BAR - a smart highlight:

Extravagant bar units as monolithic glass cabinets in the living room – can stand alone, be integrated, pivoted and illuminated as required.

Distinctive media talent:

TV centre in concrete grey as a visual contrast and appropriately sized lowboards for a perfect integration of large flat screens and standard integrated cable apertures.

Contents

	Page
Range introduction, list of versions, important notes	2-3
Special combinations	4
Suggested combinations	5-7
3 Raster lowboards	8-9
3 and 4 Raster TV centre, (wall) extendable lowboards for TV centre	10-11
4 Raster sideboards	12-13
6 Raster rotary bar, 8 Raster highboard, 10 Raster cabinet	14
Wall units	15
Media accessories for lowboards, column system, flat screen supports	16-17
Accessories for drawers	18
Fitted shelves, lamps, remote control	19
Dining, coffee tables	20

General information:

Cable apertures	21
Switch options for lamps	22-23
Special-sized products, special articles	24
Important notes: quality of walls / assembly instruction	25

Lists of versions

Model no.	Carcase and front	Price group	Model no.	Accent
648 695	Pure white lacquer Planked oak	I II	656	Concrete grey 
Note: Inner carcasse and interior fittings always in pure white lacquer (except: 6 Raster revolving bar and 10 Raster cabinet).			Note: The concrete grey colour accent version is only available for selected components. These are especially marked.	

Changing versions:

With FENA units it is also possible to order the cover shelf in a different version (without surcharge). Please state clearly in the order.

Versions of handles and metal substructures

Standard version of handles and metal substructures

- for furniture in pure white lacquer: high-gloss chrome
 - for furniture in planked oak: antique silver
 If the handles and metal substructures of the furniture in pure white lacquer are required in antique silver resp. of the furniture in planked oak are required in high-gloss chrome, please state this clearly in the order!

Important notes

Changing versions:

With FENA units it is also possible to order the cover shelf in a different version (without surcharge). Please state clearly in the order.

Accent:

The concrete grey accent colour version is only available for selected components. These are especially marked.

Versions of handles and metal substructures

Standard version of handles and metal substructures
 - for furniture in pure white lacquer: high-gloss chrome
 - for furniture in planked oak: antique silver

If the handles and metal substructures of the furniture in pure white lacquer are required in antique silver resp. of the furniture in planked oak are required in high-gloss chrome, please state this clearly in the order!

Glass versions:

Glass door of rotary bar and of cabinet and **glass shelves** behind fronts of clear glass

Standard interior fittings:

1 fitted shelf is fitted behind 3 and 4 Raster high doors.

Drawer frames in grey

Wall units:

Wall units always incl. wall bracket

Combinations of floor and wall units:

If floor and wall units are combined within an arrangement, there must not be any skirting boards in the room near the floor units, otherwise they must be removed.

Max. load:

Maximum load of wooden and glass shelves (up to 70.4 cm width) as well as drawers: 25 kg

Max. load of wooden and glass shelves (between 70.4 and 105.6 cm width): 15 kg;

from 105.6 cm width: 10 kg

Max. load of cover shelves: 35 kg per metre length for floor units.

Please also note any maximum loads which may be stated in the type list for the individual units!

hülsta-Push-to-open:

Drawers and hinge-doors of rotary bar and cabinet with hülsta-Push-to-open.

All drawers on hidden bearings as fully pull-out units.

Labelling in type list drawings / assembly notes for wall units

Labelling in type list drawings / assembly notes for wall units

The majority of units have two wall mounting points (= number of base plates), if these are to be fitted as wall units. This is not explicitly mentioned in the type list. If a different number of wall mounting points (= base plates) is required, this is marked in the drawings in the type list with numbers in black boxes.

Please be sure to note here the information and notes in the "Wall composition" chapter!

3

4

Notes on delivery

Notes on delivery:

The majority of the units are delivered standard as **fully connected units (glued)** so that the carcass **cannot be disassembled**. There are however some **exceptions** to this rule:

Some carcasses are delivered as complete units but can be **disassembled into individual sections** in the final customer's home. These types are marked with a **1** in the type list.

Some carcasses are delivered **in individual sections** because of their size. These types are marked with a **2** in the type list.

The fronts with the number **2** are delivered separately and can therefore always be (dis-) assembled.

Wall fitting

Important notes: Generally speaking, you as a dealer/qualified fitter are responsible for the correct wall mounting of the units. That is why wall mounting should only be carried out by properly trained and qualified fitters. hülsta supplies materials for mounting units on walls for nearly all the units and which should be used for safety and for constructional reasons. The assembly materials supplied by hülsta (plugs, screws) are only suitable for fitting components on to concrete in firmness class C12/15.

For other materials (please see separate materials table in the wall composition chapter) we provide you with an assembly mortar set as an extra order. Please note that this assembly mortar set is also only suitable for the materials listed in the materials table. If walls are made up of other materials (e.g. plastered or lighter wall materials), one should use another method of mounting better suited to the load on site. Please note that if the units are not mounted properly on the wall, there is a risk of the units falling down or tipping over – especially when alternative mounting materials acquired on site have been used. For the reasons stated above it is absolutely essential to enquire about the composition of any walls before signing any contracts.

Special combinations

Please state the required handle version clearly in the order!

Special combinations are arrangements that are reduced in price. This price advantage is only available when the arrangement is ordered exactly as described. The special combinations can be enhanced by including accessories. These are charged extra.

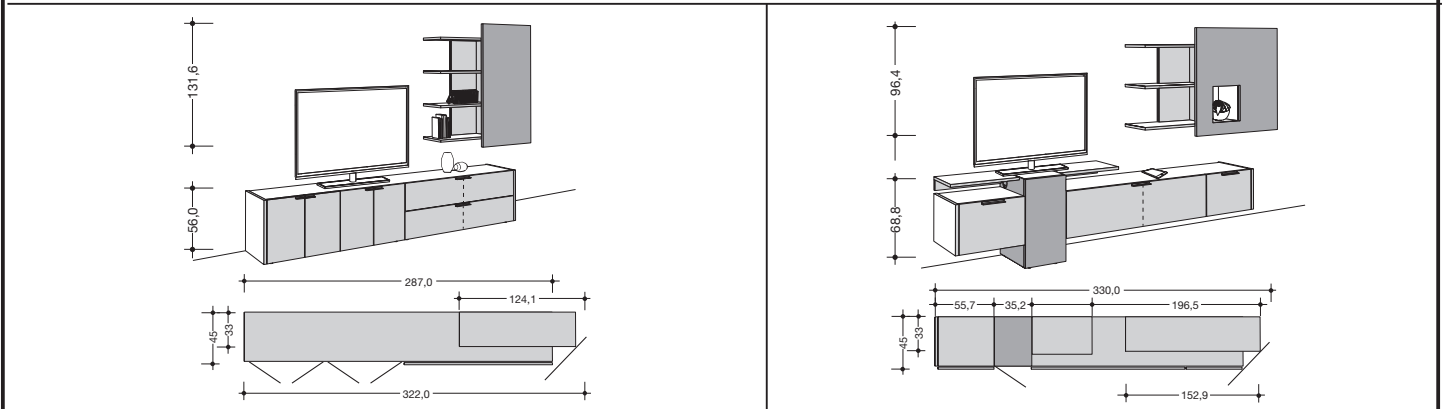

	Lowboard with 4 doors and 2 drawers	Lowboard with 4 doors, 1 flap (top) and 1 drawer	Lowboard with 4 folding-doors and 2 drawers	Lowboard with 4 folding-doors, 1 flap (top) and 1 drawer	Extendable wall lowboard with 3 drawers	Extendable wall lowboard with 2 flaps and 1 drawer (right)	Extendable wall lowboard with 1 flap (left) and 2 drawers	Extendable wall lowboard with 1 flap (centre) and 2 drawers
as illustr. v. versa	990001 990101	991001 991101	992001 992101	993001 993101	990002 990102	991002 991102	992002 992102	993002 993102
Price gr. I II	-	-	-	-	-	-	-	-

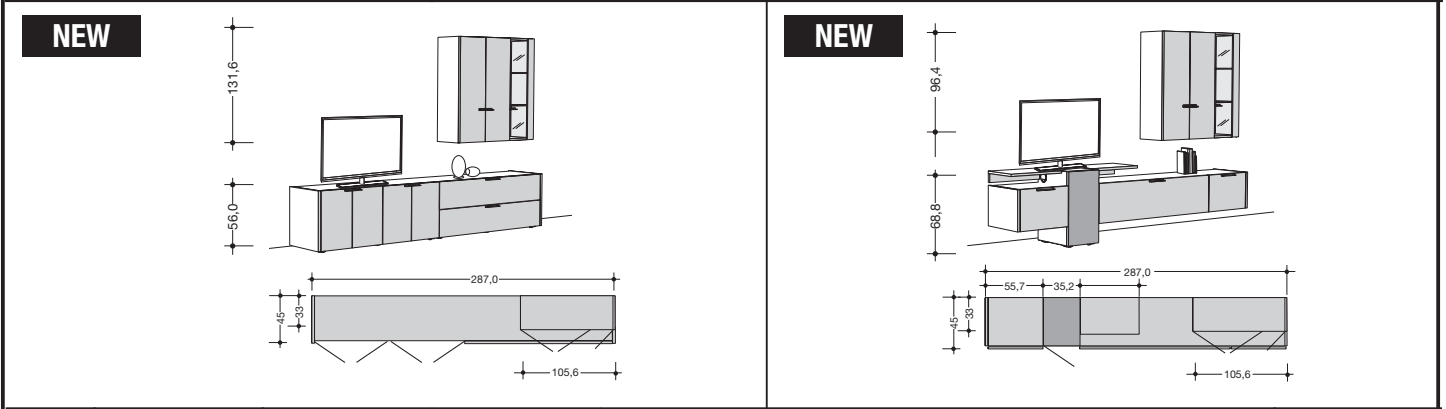

	Lowboard with 4 doors and 2 drawers	Lowboard with 4 doors, 1 flap (top) and 1 drawer	Lowboard with 4 folding-doors and 2 drawers	Lowboard with 4 folding-doors, 1 flap (top) and 1 drawer	Extendable wall lowboard with 3 drawers	Extendable wall lowboard with 2 flaps and 1 drawer (right)	Extendable wall lowboard with 1 flap (left) and 2 drawers	Extendable wall lowboard with 1 flap (centre) and 2 drawers
as illustr. v. versa	990005 990105	991005 991105	992005 992105	993005 993105	990006 990106	991006 991106	992006 992106	993006 993106
Price gr. I II	-	-	-	-	-	-	-	-

Suggested combinations

FENA

As an alternative to planning an individual unit from the complete range there is the possibility of choosing from specially suggested combinations. This eases planning. Incorporating accessories can enhance the suggested combinations. These are charged extra.

	Extendable lowboard with 4 doors			Extendable lowboard with 4 drawers	Extendable lowboard with 1 flap (top left) and 3 drawers	Extendable lowboard with 2 flaps (top) and 2 drawers									
as illustr. v. versa	980001 980101			980002 980102	981002 981102	982002 982102									
Price gr. I II	-			-	-	-									
	Extendable wall lowboard with 2 drawers	Extendable wall lowboard with 2 flaps	Extendable wall lowboard with 1 flap (left) and 1 drawer	Extendable wall lowboard with 1 flap (left) and 1 flap	Extendable wall lowboard with 3 drawers	Extendable wall lowboard with 2 flaps and 1 drawer (right)	Extendable wall lowboard with 1 flap (left) and 2 drawers	Extendable wall lowboard with 1 flap (centre) and 2 drawers							
as illustr. v. versa	980003 980103	981003 981103	982003 982103	983003 983103	980004 980104	981004 981104	982004 982104	983004 983104							
Price gr. I II	-	-	-	-	-	-	-	-							
	Extendable wall lowboard with 2 drawers	Extendable wall lowboard with 2 flaps	Extendable wall lowboard with 1 flap (left) and 1 drawer	Extendable wall lowboard with 1 flap (left) and 1 flap	Lowboard left with 4 doors; lowboard right with 2 drawers	Lowboard left with 4 doors; lowboard right with 1 flap (top) and 1 drawer	Lowboard left with 4 folding-doors; lowboard right with 2 drawers	Lowboard left with 4 folding-doors; lowboard right with 1 flap (top) and 1 drawer							
as illustr. v. versa	980005 980105	981005 981105	982005 982105	983005 983105	980007 980107	981007 981107	982007 982107	983007 983107							
Price gr. I II	-	-	-	-	-	-	-	-							

Suggested combinations

Please state the required handle version clearly in the order!

As an alternative to planning an individual unit from the complete range there is the possibility of choosing from specially suggested combinations. This eases planning. Incorporating accessories can enhance the suggested combinations. These are charged extra.

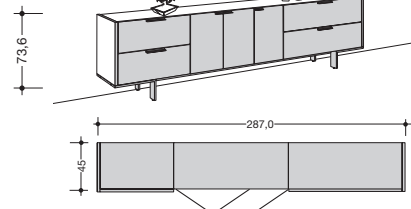
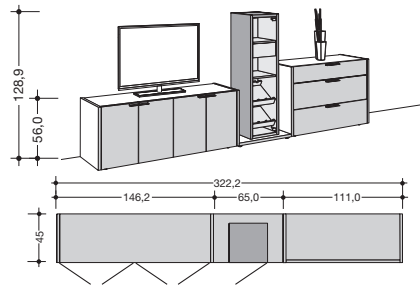

	Lowboard left with 4 doors; sideboard right with 3 drawers	Lowboard left with 4 doors; sideboard right with 1 flap (centre) and 2 drawers	Lowboard left with 4 folding-doors; sideboard right with 3 drawers	Lowboard left with 4 folding-doors; sideboard right with 1 flap (centre) and 2 drawers	Lowboard with 4 drawers and 3 doors	Lowboard with 2 drawers left, 3 doors and 1 flap (top right) and 1 drawer	Lowboard with 1 flap (top left) and 1 drawer, 3 doors and 2 drawers right	Lowboard with 2 flaps (top left and right) and 2 drawers and 3 doors
as illustr. v. versa	980008 980108	981008 981108	982008 982108	983008 983108	980009 980109	981009 981109	982009 982109	983009 983109
Price gr.	-	-	-	-	-	-	-	-
I	-	-	-	-	-	-	-	-
II	-	-	-	-	-	-	-	-

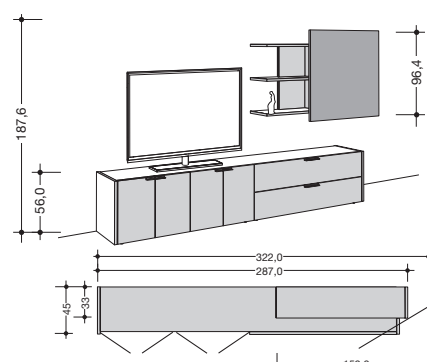
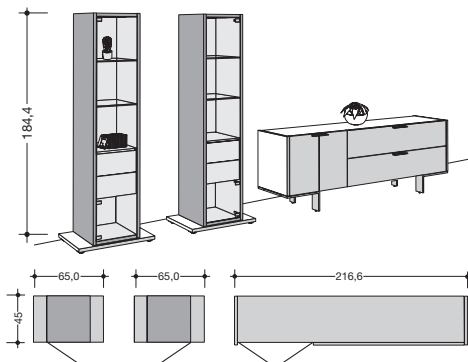

	Lowboard with 2 doors and 2 drawers	Lowboard with 2 doors, 1 flap (top) and 1 drawer	Lowboard with 4 doors and 2 drawers	Lowboard with 4 doors, 1 flap (top) and 1 drawer	Lowboard with 4 folding-doors and 2 drawers	Lowboard with 4 folding-doors, 1 flap (top) and 1 drawer
as illustr. v. versa	980010 980110	981010 981110	980011 980111	981011 981111	982011 982111	983011 983111
Price gr.	-	-	-	-	-	-
I	-	-	-	-	-	-
II	-	-	-	-	-	-

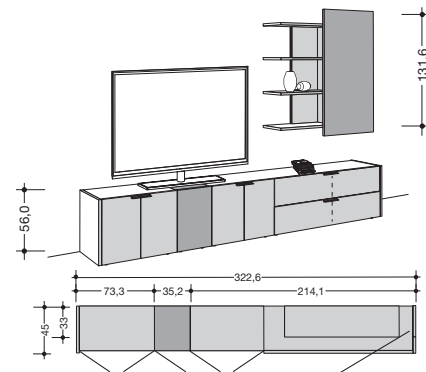
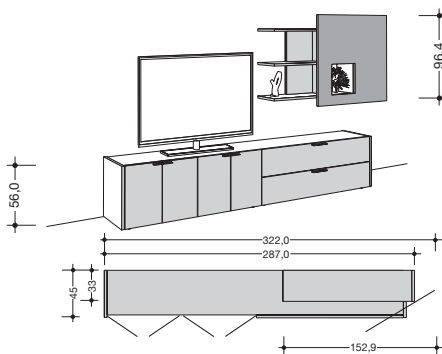

	Lowboard with 4 doors and 2 drawers	Lowboard with 4 doors, 1 flap (top) and 1 drawer	Lowboard with 4 folding-doors and 2 drawers	Lowboard with 4 folding-doors, 1 flap (top) and 1 drawer	Extendable lowboard left with 2 doors; extendable lowboard right with 2 doors and 2 drawers	Extendable lowboard left with 2 doors; extendable lowboard right with 2 doors and 1 flap (top) and 1 drawer
as illustr. v. versa	980012 980112	981012 981112	982012 982112	983012 983112	980013 980113	981013 981113
Price gr.	-	-	-	-	-	-
I	-	-	-	-	-	-
II	-	-	-	-	-	-

Suggested combinations

FENA

As an alternative to planning an individual unit from the complete range there is the possibility of choosing from specially suggested combinations. This eases planning. Incorporating accessories can enhance the suggested combinations. These are charged extra.

	Extendable lowboard left with 2 doors; extendable lowboard right with 2 doors and 2 drawers	Extendable lowboard left with 2 doors; extendable lowboard right with 2 doors and 1 flap (top) and 1 drawer	Lowboard with 4 doors and 2 drawers	Lowboard with 4 doors, 1 flap (top) and 1 drawer	Lowboard with 4 folding-doors and 2 drawers	Lowboard with 4 folding-doors, 1 flap (top) and 1 drawer	
as illustr. v. versa	980014 980114	981014 981114	980015 980115	981015 981115	982015 982115	983015 983115	
Price gr. I II	- -	- -	- -	- -	- -	- -	
	Extendable wall lowboard with 3 drawers	Extendable wall lowboard with 2 flaps and 1 drawer (right)	Extendable wall lowboard with 1 flap (left) and 2 drawers	Extendable wall lowboard with 1 flap (centre) and 2 drawers			
as illustr. v. versa	980016 980116	981016 981116	982016 982116	983016 983116			
Price gr. I II	- -	- -	- -	- -			

3 Raster lowboards





Cover shelf of lowboards optionally available in **concrete grey** version (without surcharge). Please state clearly in the order!

3 Raster lowboards
 54.2 cm high
 (56.0 cm high incl. 1.8 cm high plinth adjusters),
 45.0 cm deep

incl. centre cable aperture behind flap in rear wall of each compartment

Interior fittings, knobs:
 See here the information on page 3

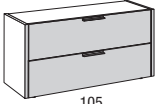
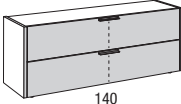
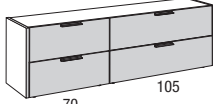
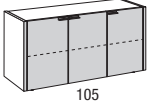
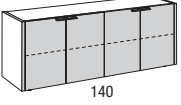
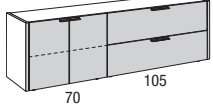
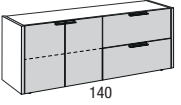
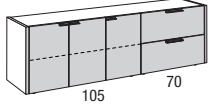
Accessories: see pages 16-19

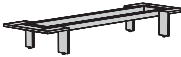
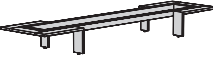



 105 111.0 cm wide	 140 146.2 cm wide	 70 105 181.4 cm wide	2 drawers	1 flap (top) and 1 drawer	2 drawers	1 flap (top) and 1 drawer	4 drawers	3 drawers and 1 flap (top right)	2 flaps (top) and 2 drawers
			as illustr. v. versa	31111	31118	31411	31418	318111 318112	318181 318182
Price gr. I	-	-	-	-	-	-	-	-	-
Price gr. II	-	-	-	-	-	-	-	-	-
 105 111.0 cm wide	 140 146.2 cm wide	 70 105 181.4 cm wide	3 doors	4 doors	4 folding-doors	2 doors and 2 drawers	2 doors and 1 flap (top) and 1 drawer		
			as illustr. v. versa	311131 311132	31413	31414	318131 318132	318231 318232	
Price gr. I	-	-	-	-	-	-	-	-	-
Price gr. II	-	-	-	-	-	-	-	-	-
 140 105 146.2 cm wide	 105 70 181.4 cm wide	2 doors and 2 drawers	2 doors and 1 flap (top) and 1 drawer	3 doors and 2 drawers	3 doors and 1 flap (top) and 1 drawer				
		as illustr. v. versa	314131 314132	314231 314232	318331 318332	318431 318432			
Price gr. I	-	-	-	-	-	-	-	-	-
Price gr. II	-	-	-	-	-	-	-	-	-
Metal substructure 19.4 cm high Units can be placed optionally on a metal substructure. In this case the plinth adjusters are omitted. Metal substructure optionally in high-gloss chrome or antique silver. Please state the required version clearly in the order!	 for 111.0 cm width	 for 146.2 cm width	 for 181.4 cm width						
		2101	2141	2181					
	-	-	-						

Notes on delivery:
Please see here the information on range introduction pages.

1
2

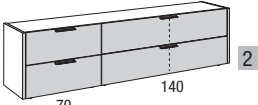
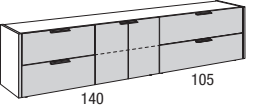
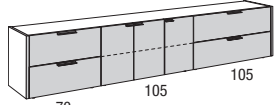
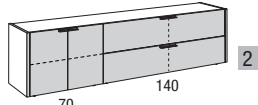
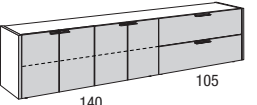
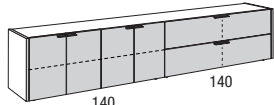
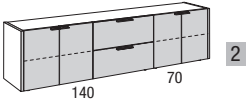
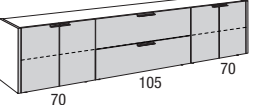
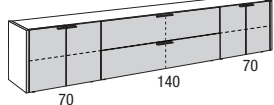
3 Raster lowboards

FENA

<p>3 Raster lowboards 54.2 cm high (56.0 cm high incl. 1.8 cm high plinth adjusters), 45.0 cm deep</p> <p>incl. centre cable aperture behind flap in rear wall of each compartment</p> <p>Interior fittings, knobs: See here the information on page 3</p> <p>Accessories: see pages 16-19</p>	 <p>70 140</p> <p>216.6 cm wide</p>	 <p>140 105</p> <p>251.8 cm wide</p>	 <p>70 105 105</p> <p>287.0 cm wide</p>	<p>4 drawers</p> <p>3 drawers and 1 flap (top right)</p> <p>2 flaps (top) and 2 drawers</p> <p>4 drawers and 2 doors</p> <p>2 drawers left, 2 doors and 1 flap (top right) and 1 drawer</p> <p>1 flap (top left) and 1 drawer, 2 doors and 2 drawers right</p> <p>2 flaps (top left and right) and 2 drawers and 2 doors</p> <p>4 drawers and 3 doors</p> <p>2 drawers left, 3 doors and 1 flap (top right) and 1 drawer</p> <p>1 flap (top left) and 1 drawer, 3 doors and 2 drawers right</p> <p>2 flaps (top left and right) and 2 drawers and 3 doors</p>								
	<p>as illustr. v. versa</p> <p>Price gr.</p> <p>I</p> <p>II</p>	<p>321111 321112</p> <p>- -</p>	<p>321181 321182</p> <p>- -</p>	<p>321281 321282</p> <p>- -</p>	<p>325131 325132</p> <p>- -</p>	<p>325231 325232</p> <p>- -</p>	<p>325331 325332</p> <p>- -</p>	<p>325431 325432</p> <p>- -</p>	<p>328131 328132</p> <p>- -</p>	<p>328231 328232</p> <p>- -</p>	<p>328331 328332</p> <p>- -</p>	<p>328431 328432</p> <p>- -</p>
	 <p>70 140</p> <p>216.6 cm wide</p>	 <p>140 105</p> <p>251.8 cm wide</p>	 <p>140 140</p> <p>287.0 cm wide</p>	<p>2 doors and 2 drawers</p> <p>2 doors and 1 flap (top) and 1 drawer</p> <p>4 doors and 2 drawers</p> <p>4 doors and 1 flap (top) and 1 drawer</p> <p>4 folding-doors and 2 drawers</p> <p>4 folding-doors and 1 flap (top) and 1 drawer</p> <p>4 doors and 2 drawers</p> <p>4 doors and 1 flap (top) and 1 drawer</p> <p>4 folding-doors and 2 drawers</p> <p>4 folding-doors and 1 flap (top) and 1 drawer</p>								
	<p>as illustr. v. versa</p> <p>Price gr.</p> <p>I</p> <p>II</p>	<p>321141 321142</p> <p>- -</p>	<p>321241 321242</p> <p>- -</p>	<p>325141 325142</p> <p>- -</p>	<p>325241 325242</p> <p>- -</p>	<p>325341 325342</p> <p>- -</p>	<p>325441 325442</p> <p>- -</p>	<p>328141 328142</p> <p>- -</p>	<p>328241 328242</p> <p>- -</p>	<p>328341 328342</p> <p>- -</p>	<p>328441 328442</p> <p>- -</p>	
	 <p>140 70</p> <p>216.6 cm wide</p>	 <p>70 105 70</p> <p>251.8 cm wide</p>	 <p>70 140 70</p> <p>287.0 cm wide</p>	<p>4 doors and 2 drawers</p> <p>4 doors and 1 flap (top) and 1 drawer</p> <p>4 doors and 2 drawers</p> <p>4 doors and 1 flap (top) and 1 drawer</p> <p>4 doors and 2 drawers</p> <p>4 doors and 1 flap (top) and 1 drawer</p>								
	<p>Price gr.</p> <p>I</p> <p>II</p>	<p>32113</p> <p>-</p>	<p>32123</p> <p>-</p>	<p>32513</p> <p>-</p>	<p>32523</p> <p>-</p>	<p>32813</p> <p>-</p>	<p>32823</p> <p>-</p>					
	<p>Metal substructure 19.4 cm high</p> <p>Units can be placed optionally on a metal substructure. In this case the plinth adjusters are omitted.</p> <p>Metal substructure optionally in high-gloss chrome or antique silver. Please state the required version clearly in the order!</p>	 <p>for 216.6 cm width</p>	 <p>for 251.8 cm width</p>	 <p>for 287.0 cm width</p>								
		<p>2211</p> <p>-</p>	<p>2251</p> <p>-</p>	<p>2281</p> <p>-</p>								

TV planning units



Carcase of 3 and 4 Raster TV centre optionally available in **concrete grey** version (without surcharge). Please state clearly in the order!

3 Raster TV centre for extendable lowboards

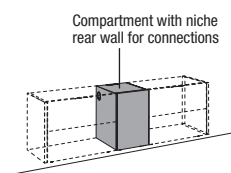
<p>3 Raster TV centre for extendable lowboards 54.2 cm high (56.0 cm high incl. 1.8 cm high plinth adjusters), 45.0 cm deep</p> <p>incl. cable aperture K8 in cover shelf and K20 in the carcass sides. Further cable apertures K20 are possible.</p> <p>The 3 Raster TV centre must be fitted between extendable lowboards (see below).</p> <p>L/R = Door hinge left/right</p>	<p>3 Raster TV centre for extendable lowboards</p>  <p>35.2 cm wide</p>		
	1 door		
	Price gr.	<p>34011 L 34012 R</p> <p>I - II -</p>	

Extendable lowboards for 3 Raster TV centre

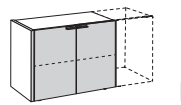
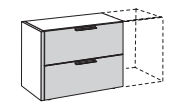
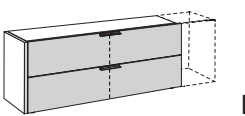
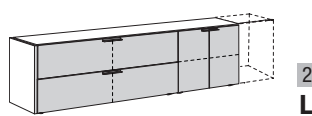

Cover shelf of lowboards optionally available in **concrete grey** version (without surcharge). Please state clearly in the order!

<p>Extendable lowboards for 3 Raster TV centre 54.2 cm high (56.0 cm high incl. 1.8 cm high plinth adjusters), 45.0 cm deep</p> <p>incl. cable aperture K20 on the side which is fitted to the TV centre. Further cable apertures K20 are possible.</p> <p>Handles: See here the information on page 3</p> <p>TV centre and extendable lowboards must be ordered in combination.</p> <p>L/R = Extendable on the left/right side of the TV centre</p>	 <p>73.3 cm wide</p>		 <p>73.3 cm wide</p>	
	2 doors		2 drawers	1 flap (top) and 1 drawer
	Ext. left Ext. right	<p>37031 L 37032 R</p>	<p>37011 L 37012 R</p>	<p>37081 L 37082 R</p>
	Price gr.	- -	- -	- -
 <p>143.7 cm wide</p>		 <p>214.1 cm wide</p>		
2 drawers		1 flap (top) and 1 drawer	2 doors and 2 drawers	2 doors and 1 flap (top) and 1 drawer
Ext. left Ext. right	<p>314011 L 314012 R</p>	<p>314081 L 314082 R</p>	<p>321031 L 321032 R</p>	<p>321081 L 321082 R</p>
Price gr.	- -	- -	- -	- -

Notes on delivery:
Please see here the information on range introduction pages.

Assembly notes for wall units:
Please be sure to note here the information and notes in the "Wall composition" chapter!

TV planning units

FENA

4 Raster TV centre for extendable wall lowboards

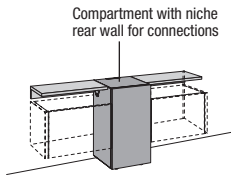
<p>4 Raster TV centre for extendable wall lowboards TV centre 67.0 cm high (68.8 cm high incl. 1.8 cm high plinth adjusters), 45.0 cm deep Storage shelves 55.7 cm wide, 35.0 cm deep; max. load 5 kg; height between storage shelf and wall extendable lowboard: 10.6 cm</p> <p>incl. cable aperture K8 in cover shelf and K20 in the carcass sides. Further cable apertures K20 are possible.</p> <p>The 4 Raster TV centre must be fitted between wall extendable lowboards (see below).</p> <p>L/R = Door hinge left/right</p>	<p>4 Raster TV centre for extendable wall lowboards</p>  <p>Compartment with niche rear wall for connections</p> <p>TV centre 35.2 cm wide; total width incl. storage shelves: 146.6 cm</p>			
	1 door			
	<p>34021 L 34022 R</p>			
<p>Price gr. I II</p>	-			

Extendable wall lowboards for 4 Raster TV centre

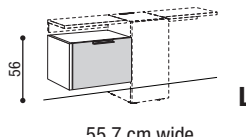
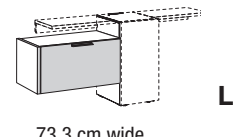
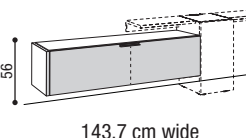
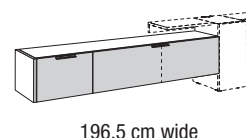

Cover shelf of lowboards optionally available in **concrete grey** version (without surcharge). Please state clearly in the order!

<p>Extendable wall lowboards for 4 Raster TV centre 36.6 cm high 45.0 cm deep</p> <p>incl. cable aperture K20 on the side which is fitted to the TV centre. Further cable apertures K20 are possible.</p> <p>Handles: See here the information on page 3</p> <p>TV centre and extendable wall lowboards must be ordered in combination.</p> <p>L/R = Extendable on the left/right side of the TV centre</p> <p>Max. load: 55.7 cm width: 7.5 kg 73.3 cm width: 10.0 kg 143.7 cm width: 20.0 kg 196.5 cm width: 27.5 kg</p>	 <p>55.7 cm wide</p>		 <p>73.3 cm wide</p>	
	1 drawer		1 flap	
	<p>Ext. left Ext. right</p> <p>25011 L 25012 R</p>		<p>25081 L 25082 R</p>	
	<p>Price gr. I II</p>		-	
 <p>143.7 cm wide</p>		 <p>196.5 cm wide</p>		
1 drawer		1 flap		
<p>Ext. left Ext. right</p> <p>214011 L 214012 R</p>		<p>214081 L 214082 R</p>		
<p>Price gr. I II</p>		-		

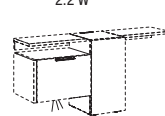
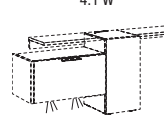
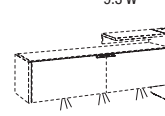
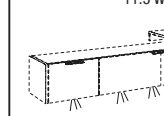

Lamps for extendable wall lowboards for 4 Raster TV centre

<p>LED light strip flush mounted</p> <p>This luminaire contains built-in LED lamps of the energy classes A+++ to A. The lamps cannot be changed in the luminaire. 12 V</p>	<p>2.2 W</p>  <p>for 55.7 cm width</p>	<p>4.1 W</p>  <p>for 73.3 cm width</p>	<p>9.3 W</p>  <p>for 143.7 cm width</p>	<p>11.5 W</p>  <p>for 196.5 cm width</p>
	522	702	1402	1902
	-			

4 Raster sideboards

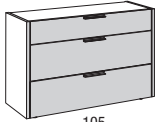
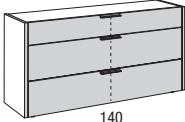
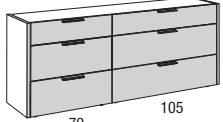
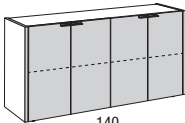
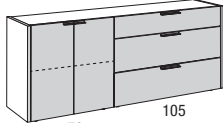
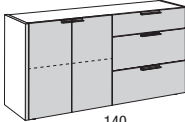
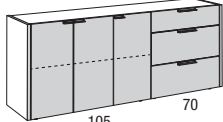

Cover shelf of sideboards optionally available in **concrete grey** version (without surcharge). Please state clearly in the order!

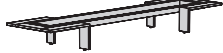
<p>4 Raster sideboards 71.8 cm high (73.6 cm high incl. 1.8 cm high plinth adjusters), 45.0 cm deep</p> <p>Interior fittings, knobs: See here the information on page 3</p> <p>Accessories: see pages 18-19</p>	 105 111.0 cm wide		 140 146.2 cm wide		 70 105 181.4 cm wide	
	3 drawers		1 flap (centre) and 2 drawers		2 flaps (centre) and 4 drawers	
	as illustr. v. versa		41111		41118	
	Price gr.		-		-	
	I		-		-	
	II		-		-	
			 140 146.2 cm wide		 70 105 181.4 cm wide	
			4 doors		4 folding-doors	
	as illustr. v. versa		41413		41414	
	Price gr.		-		-	
I		-		-		
II		-		-		
		 140 146.2 cm wide		 105 70 181.4 cm wide		
		2 doors and 3 drawers		2 doors and 1 flap (centre) and 2 drawers		
as illustr. v. versa		414131		414231		
Price gr.		414132		414232		
I		-		-		
II		-		-		
Metal substructure 19.4 cm high		 for 111.0 cm width		 for 146.2 cm width		
Units can be placed optionally on a metal substructure. In this case the plinth adjusters are omitted.						
Metal substructure optionally in high-gloss chrome or antique silver. Please state the required version clearly in the order!		2101		2141		
		-		-		
				 for 181.4 cm width		
				2181		
		-		-		

Notes on delivery:
Please see here the information on range introduction pages.

1
2

4 Raster sideboards

FENA

4 Raster sideboards
71.8 cm high
(73.6 cm high incl. 1.8 cm high plinth adjusters),
45.0 cm deep

Interior fittings, knobs:
See here the information on page 3

Accessories: see pages 18-19

<p>216.6 cm wide</p>	<p>251.8 cm wide</p>	2 doors and 3 drawers		2 doors and 1 flap (centre) and 2 drawers		6 drawers and 2 doors		2 flaps (centre) and 4 drawers and 2 doors							
		as illustr. v. versa		421141	421241	425131	425231	-		-					
<p>216.6 cm wide</p>		<p>251.8 cm wide</p>		3 doors and 3 drawers		3 doors and 1 flap (centre) and 2 drawers		4 doors and 3 drawers		4 doors and 1 flap (centre) and 2 drawers		4 folding-doors and 3 drawers		4 folding-doors and 1 flap (centre) and 2 drawers	
as illustr. v. versa		421341	421441	425141	425341	425241	425441	-		-		-		-	
<p>216.6 cm wide</p>		<p>251.8 cm wide</p>		4 doors and 3 drawers		4 doors and 1 flap (centre) and 2 drawers		4 doors and 3 drawers		4 doors and 1 flap (centre) and 2 drawers		-		-	
as illustr. v. versa		42113	42123	42513	42523	-		-		-		-		-	
<p>Metal substructure 19.4 cm high</p> <p>Units can be placed optionally on a metal substructure. In this case the plinth adjusters are omitted.</p> <p>Metal substructure optionally in high-gloss chrome or antique silver. Please state the required version clearly in the order!</p>		<p>for 216.6 cm width</p> <p>2211</p>		<p>for 251.8 cm width</p> <p>2251</p>		-		-		-		-		-	
Price gr.		-		-		-		-		-		-		-	



Carcass of rotary bar optionally available in **concrete grey** version (without surcharge). Please state clearly in the order!

6 Raster rotary bar

6 Raster rotary bar

128.9 cm high;
on plinth shelf, 2.6 cm thick
(4.4 cm high incl. 1.8 cm high
plinth adjusters);
65.0 cm wide, 45.0 cm deep;
rotary cabinet with bar
function 124.5 cm high,
35.2 cm wide, 35.1 cm deep

Inside drawers, shelves and
plinth shelf not available in
concrete grey version. In this
case please state the required
version clearly in the order!

Door and inside drawer with
hülsta-Push-to-open

Integrated LED spotlight

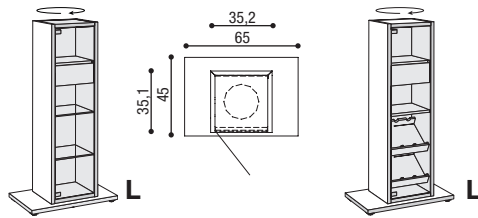

max. 65.0 cm wide

Integrated LED spotlight (set of 2)

Ø 4.8 cm;
for fitting in plinth shelf of rotary bar, optionally at front and/or at
rear and left and/or right. A maximum of two sets can be fitted
in the plinth shelf (see sketch). Please state the required position
clearly in the order! Integrated LED spotlight incl. footswitch.

This luminaire contains built-in LED lamps of the energy classes A++ to A.
The lamps cannot be changed in the luminaire. 12 V; 2x 2.0 W

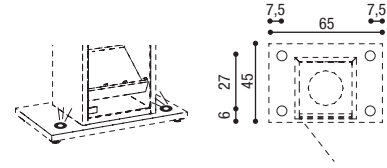

	1 glass door		
	Bar interior fittings: 1 inside drawer 2 glass shelves Rear wall mirror	Bar interior fittings: 1 inside drawer 2 bottle shelves 1 wooden shelf Rear wall mirror	
	65441 L 65442 R	65341 L 65342 R	7942
Price gr. I II	- -	- -	-

8 Raster highboard

8 Raster highboard

143.8 cm high
(145.6 cm high incl. 1.8 cm
high plinth adjusters),
45.0 cm deep

Handles:

See here the information
on page 3

Metal substructure

19.4 cm high

Units can be placed optionally
on a metal substructure. In this
case the plinth adjusters are
omitted.

Metal substructure optionally
in high-gloss chrome or
antique silver. Please state
the required version clearly in
the order!

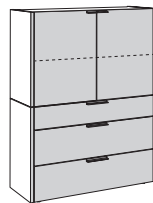

111.0 cm wide



for 111.0 cm width

	2 doors and 3 drawers	2 doors and 1 flap (centre) and 2 drawers	
	8103	8108	2101
Price gr. I II	- -	- -	-

10 Raster cabinet



Carcass of cabinet optionally available in **concrete grey** version (without surcharge). Please state clearly in the order!

10 Raster cabinet

184.4 cm high;
on plinth shelf, 2.6 cm thick
(4.4 cm high incl. 1.8 cm high
plinth adjusters);
65.0 cm wide, 45.0 cm deep;
cabinet 180.0 cm high,
40.2 cm wide, 43.0 cm deep

Inside drawers, shelves and
plinth shelf not available in
concrete grey version. In this
case please state the required
version clearly in the order!

Door and inside drawers with
hülsta-Push-to-open

Integrated LED spotlight

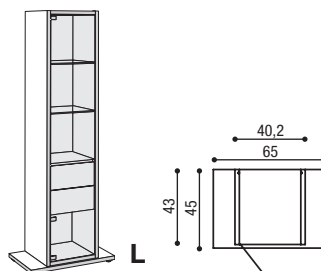

max. 65.0 cm wide

Integrated LED spotlight (set of 2)

Ø 4.8 cm;
for fitting in plinth shelf of cabinet, optionally at front and/or at
rear and left and/or right. A maximum of two sets can be fitted
in the plinth shelf (see sketch). Please state the required position
clearly in the order! Integrated LED spotlight incl. footswitch.

This luminaire contains built-in LED lamps of the energy classes A++ to A.
The lamps cannot be changed in the luminaire. 12 V; 2x 2.0 W

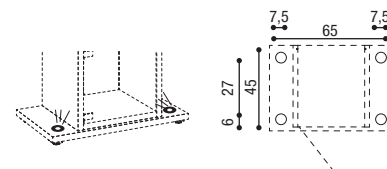



	1 glass door		
	105341 L 105342 R		7942
Price gr. I II	- -		-

Wall units

Notes on delivery:
Please see here the information on range introduction pages.

Assembly notes for wall units:
Please be sure to note here the information and notes in the "Wall composition" chapter!

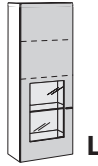
FENA

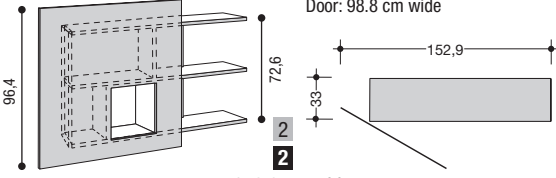
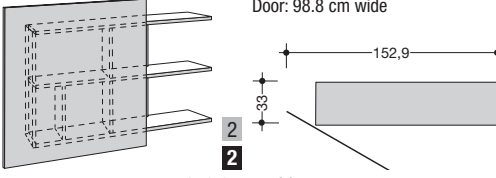
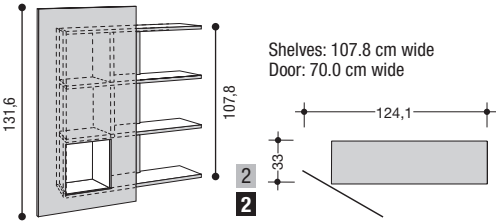
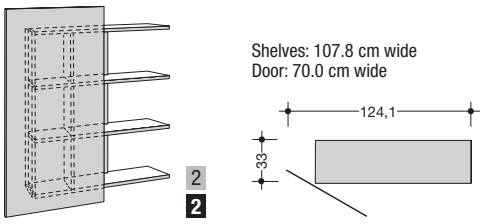
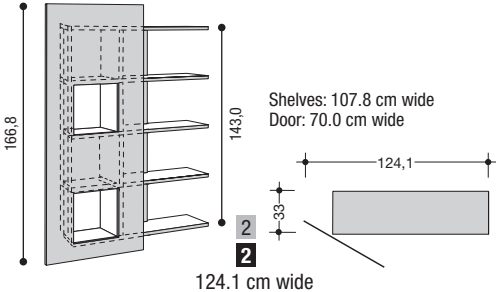
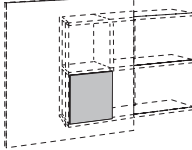
<p>6 Raster wall unit 105.6 cm high; 32.8 cm deep</p> <p>8 Raster wall unit 140.8 cm high; 32.8 cm deep</p> <p>Max. load: 40 kg</p> <p>Wall units or wall assembly: See here the information on page 3</p>	<p>6 Raster wall unit</p> <p style="text-align: center;">NEW</p>  <p>105.6 cm wide</p> <p>2 doors; 1 glass door</p>	<p>8 Raster wall unit</p> <p style="text-align: center;">NEW</p>  <p>52.8 cm wide</p> <p>1 door with glass inset</p>
	<p>as illustr. v. versa</p> <p>Price gr.</p> <p>I -</p> <p>II -</p>	<p>610241 610242</p> <p>-</p> <p>-</p>
<p>4 Raster wall units max. 96.4 cm high; 33.0 cm deep</p> <p>Consisting of 1 hinge-door, 1 rear wall panel, 3 shelves, 1 outer side section and 3 centre partitions</p> <p>Max. load: 25 kg</p> <p>Wall units or wall assembly: See here the information on page 3</p>	<p> Hinge-door and door panel of wall units optionally available in concrete grey version (without surcharge). Please state clearly in the order!</p>	
	 <p>Shelves: 125.4 cm wide Door: 98.8 cm wide</p> <p>152.9 cm wide</p> <p>1 door with cut-out section</p>	 <p>Shelves: 125.4 cm wide Door: 98.8 cm wide</p> <p>152.9 cm wide</p> <p>1 door</p>
<p>as illustr. v. versa</p> <p>Price gr.</p> <p>I -</p> <p>II -</p>	<p>41511 41512</p> <p>-</p> <p>-</p>	<p>41501 41502</p> <p>-</p> <p>-</p>
<p>6 Raster wall units max. 131.6 cm high; 33.0 cm deep</p> <p>Consisting of 1 hinge-door, 1 rear wall panel, 4 shelves, 1 outer side section and 3 centre partitions</p> <p>Max. load: 25 kg</p> <p>Wall units or wall assembly: See here the information on page 3</p>	 <p>Shelves: 107.8 cm wide Door: 70.0 cm wide</p> <p>124.1 cm wide</p> <p>1 door with cut-out section</p>	 <p>Shelves: 107.8 cm wide Door: 70.0 cm wide</p> <p>124.1 cm wide</p> <p>1 door</p>
	<p>as illustr. v. versa</p> <p>Price gr.</p> <p>I -</p> <p>II -</p>	<p>61211 61212</p> <p>-</p> <p>-</p>
<p>8 Raster wall unit max. 166.8 cm high; 33.0 cm deep</p> <p>Consisting of 1 hinge-door, 1 rear wall panel, 5 shelves, 1 outer side section and 4 centre partitions</p> <p>Max. load: 25 kg</p> <p>Wall units or wall assembly: See here the information on page 3</p>	 <p>Shelves: 107.8 cm wide Door: 70.0 cm wide</p> <p>124.1 cm wide</p> <p>1 door with 2 cut-out sections</p>	 <p>33.5 x 33.5 cm</p> <p>Panel for door cut-out section</p>
	<p>as illustr. v. versa</p> <p>Price gr.</p> <p>I -</p> <p>II -</p>	<p>81211 81212</p> <p>-</p> <p>-</p>
<p>Panel for door cut-out section For placing in the door</p>		

Media accessories for lowboards

IR repeater set

IR repeater set

Infrared signal transmission set for operating media units behind wooden/lacquered fronts. You can operate all the units in one compartment with one set. The following applies:

- One set must be used in each compartment. 2 transmitters can also be installed in large compartments in order to increase performance. In this case only one additional transmitter needs to be ordered.
- The transmitter must be placed in the direct vicinity of the receiver eye.
- Transmittable IR frequency band 20 – 60 kHz
- Up to 3 transmitters can be combined with one receiver.

It is possible to use 3 transmitters via 1 receiver including Master box. This enables simultaneous operation of 3 different furniture compartments or in critical situations it allows fitting out one furniture compartment with several transmitters in order to increase the performance in this compartment or to operate 2 end units placed next to one another.

The IR repeater set consists of:

- 1 receiver eye (Ø 3.0 cm) incl. standing bracket
- 1 electrical transmitter
- 1 plug EVG 12 V
- Cable clips

Please note the details stated in the operating instructions!

IR repeater set 1 receiver eye and 1 transmitter incl. standing bracket
2001 -
Extra transmitter 2003 -

Cable apertures / subwoofer base cut-out section

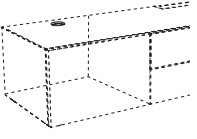
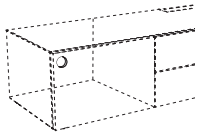
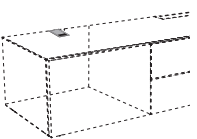
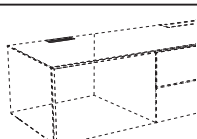
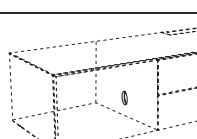
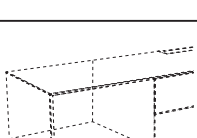
 <p>Cable aperture K1 Silver coloured; Ø 8.0 cm; It is possible to fit a cable aperture in the cover shelf of lowboards. The cable aperture can be made at the rear of the top shelf. The position is in the centre of the compartment, distance from centre of aperture to rear edge of unit: 10.0 cm</p>	K1 -
 <p>Cable aperture K2 Silver coloured; Ø 8.0 cm; It is possible to fit a cable aperture in the rear wall of the lowboard. Positioned at centre of compartment.</p>	K2 -
 <p>Cable aperture K7 Silver coloured; 7.0 x 12.0 cm; It is possible to fit a cable aperture in the cover shelf of lowboards. The position is in the centre of the compartment, flush with the rear edge of the unit.</p>	K7 -
 <p>Cable aperture K8 Silver-coloured; 12.8 x 3.2 cm; It is possible to fit a cable aperture in the cover shelf of lowboards. The cable aperture is possible in the rear edge of the cover shelf. The position is in the centre of the compartment.</p>	K8 -
 <p>Cable aperture K20 Silver coloured; Ø 8.0 cm; It is possible to fit a cable aperture in the partitions of the lowboard.</p>	K20 -
 <p>Subwoofer shelf aperture Oval base cut-out section 12 x 23.2 cm; The sounds from the subwoofer pass out through the base cut-out section in the lowboard without hindrance. The exact position in the carcass is predetermined ex-works and cannot be altered.</p>	14 -

TV columns

TV columns can be rotated and adjusted in angle, for fitting on **floor lowboards with partition** (not possible with 2 Raster lowboards with 2 drawers on top of one another and wall lowboards). The TV column can only be fitted above a partition. The partition is provided with a cut-out section for cables (no surcharge). No drawers are possible below the TV column.

The revolving TV column 52 is suitable for flat screens with a screen diagonal of 38"-52" (96-132 cm), max. load: 35 kg
TV revolving column 52 compatible with VESA Norm standard:
min. 75 x 75 mm, max. 400 x 400 mm

The revolving TV column 65 is suitable for flat screens with a screen diagonal of 38"-65" (96-165 cm), max. load: 40 kg
TV revolving column 65 compatible with VESA Norm standard:
min. 75 x 75 mm, max. 800 x 400 mm

TV column 52

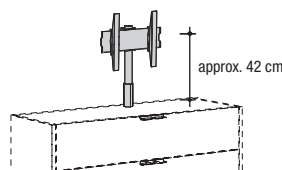

TV column 65

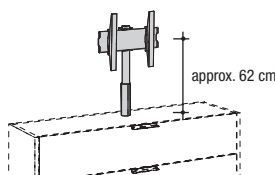

TV column 52	TV column 65
9404	9403
-	-

Column system, flat screen supports

Column system

consisting of a metal column (for fitting anywhere on wall) and of audio/DVD support(s), for fitting anywhere on column.

Example of use:

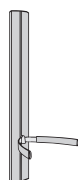

Columns

of metal; for fitting anywhere on walls above top rim of plinth slot; cables can be laid and hidden at any height; audio/DVD supports can be fitted anywhere on the column.



36.8 cm high	64.1 cm high
9201	9202
-	-

Audio/DVD support

of metal; can be positioned at any height on the column and be adjusted to suit audio/DVD players of any size; with rubber padding at front to prevent units from slipping; max. load: 10 kg



9203
-

Flat screen support WTL6

The flat screen support can be adjusted 3-dimensionally. It is suitable for flat screens with a screen diagonal of 102-216 cm (40"-85"); max. load: 45 kg.
Suitable for Curved TV's.
Flat screen support compatible with VESA Norm standard:
min.: 200 x 200 mm
max.: 600 x 400 mm



for fitting anywhere on wall
9704
-

Flat screen support THIN 345, ideally adaptable

The flat screen support can be adjusted 3-dimensionally. It is suitable for flat screens with a screen diagonal of 102-165 cm (40"-65") and a maximum depth of 5.0 cm; max. load: 25 kg.
Go to www.vogels.com to check if your flat screen can be fitted on this flat screen support. Enter the name THIN 345. After a few steps you can see if your flat screen TV is compatible with the flat screen support.
Not suitable for Curved TV's.
Flat screen support compatible with VESA Norm standard:
min.: 100 x 100 mm
max.: 600 x 400 mm

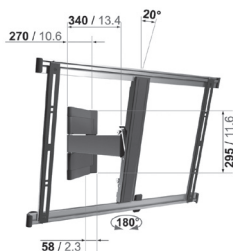

for fitting anywhere on wall
9304
-

Flat screen support THIN 315



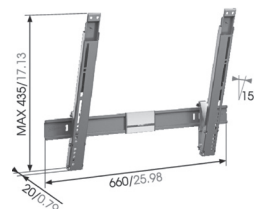



The flat screen support can be angled up to a max. 15°. It is suitable for flat screens with a screen diagonal of 102-165 cm (40"-65") and a maximum depth of 5.0 cm; max. load: 25 kg.
Go to www.vogels.com to check if your flat screen can be fitted on this flat screen support. Enter the name THIN 315. After a few steps you can see if your flat screen TV is compatible with the flat screen support.
Not suitable for Curved TV's.
Flat screen support compatible with VESA Norm standard:
min.: 100 x 100 mm
max.: 600 x 400 mm











for fitting anywhere on wall
9504
-

Accessories for units



Accessories for drawers

		for 35 cm front width	for 52 cm front width	for 70 cm front width	for 105 cm front width	for 1/2 drawer, 140 cm wide
	Tableau lined with grey fabric	8624 -	8625 -	8626 -	8627 -	8626 -
	CD holder for drawers Please state exactly in your order and drawing in which 2 Raster drawer the CD holder is to be fitted.	X		for 54 CD's 8425 -	for 72 CD's 8426 -	for 126 CD's 8427 -
	DVD/Blu-Ray holder for drawers Please state exactly in your order and drawing in which 2 Raster drawer the DVD/Blu-Ray holder is to be fitted.	X		for 24 DVD's 8325 -	for 36 DVD's 8326 -	for 48 DVD's 8327 -
 	Cutlery box of metal, lined with grey fabric inside; incl. compartments				17.6 cm wide	35.2 cm wide
					855 -	856 -
	Cutlery holder lined with grey fabric, for fitting in drawers Set 1: for 60 pcs of cutlery Set 2: for 17 serving utensils				Set 1: for standard cutlery like spoons, forks, knives, etc.	Set 2: for sauce ladles, cake forks, cake servers, etc.
					116 -	117 -

Fitted shelves

 <p>Fitted shelf 1.9 cm thick</p>	for 35 cm front width	for 52 cm front width	for 70 cm front width and 1/2 compartment of 140 cm front width	for 105 cm front width (not possible behind flaps)
	134 -	154 -	174 -	1104 -
<p>NEW</p>  <p>Fitted shelf for 6 and 8 Raster wall unit 1.9 cm thick</p>	 <p>wide fitted shelf</p>		 <p>short fitted shelf</p>	
	 <p>Wooden shelf</p>		 <p>Glass shelf</p>	
	 <p>Wooden shelf</p>		 <p>Glass shelf</p>	
	Price gr.	173	333	Price gr.
II	-	-	II	-

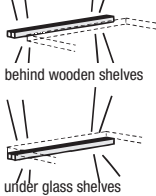
Lamps

<p>This luminaire contains built-in LED lamps of the energy classes A++ to A. The lamps cannot be changed in the luminaire. 12 V</p>		<p>LED lamps incl. footswitch. A remote control unit is possible for operating the LED lamps (against a surcharge; see below).</p>	
<p>NEW</p>  <p>LED light panel 1.9 cm thick, 3.0 cm deep; for fitting in units</p> <p>behind wooden shelves</p> <p>under glass shelves</p>	for 35 cm front width	for 52 cm front width	
	2.4 W	3.5 W	
<p>NEW</p>  <p>Glass rim lamp 1.0 cm thick, 1.1 cm deep; LED light strip in aluminium profile, for fitting behind fitted glass shelves</p>	2.4 W	3.5 W	
	363	523	
 <p>Integrated LED spotlamp Ø 7.1 cm</p>	2.9 W		
	7941		

Remote control unit with changing colours

The lamps are normally operated by an external footswitch. The colour temperature of the LED lamps is cold white if a footswitch is used. A 4-channel remote control unit is also available as an alternative, which is charged extra. Several lamps can be operated with each of the 4 channels. All 4 channels can be dimmed separately at the push of a button. The colour temperature of all 4 channels can be set to any level from cold white (approx. 6500 kelvin = the basic setting of the LED lamps) to warm white (approx. 2700 kelvin). If warm white is required, a remote control unit must be ordered. It is also possible to switch all channels on and off simultaneously with the "all on" or "all off" buttons. Up to 4 transmitters can operate as many receivers as required. The remote control unit consists of one transmitter and one receiver. If several receivers are required because of the arrangement of the units, these and the corresponding cables are provided ex-works (no surcharge). The footswitch is omitted when the remote control unit is used.



2019

DINING Dining tables and chairs

DINING

hülsta offers a room concept to meet all requirements in comfort, beauty of form and attractiveness with a comprehensive collection of dining room tables and chairs.

The **dining tables** in a wide variety of sizes (with and without pullout function) in all wood surface versions and in contemporary designs, as well as the **dining chairs** that can be combined individually using different armrests, comfort features, high-grade cover fabrics (leather, textiles) and metal surfaces can all be found in the “**DINING**” type list.



Coffee tables CT 180

Coffee tables CT 180

The **CT 180** coffee table in sizes of 111 x 47.6 cm and 111 x 111 cm provides one or two drawers which are opened in opposite directions.

You will find the CT 180 coffee table as well as other coffee tables in the “**Coffee tables**” type list.



Coffee tables

Coffee tables

hülsta offers a comprehensive **collection of coffee tables**, which not only match the hülsta furniture ranges perfectly but can also be combined with other products that are available on the market. You will find these coffee tables in a number of designs, sizes and versions in the “**Coffee tables**” type list.

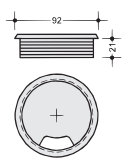
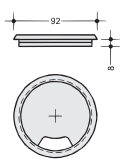
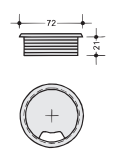
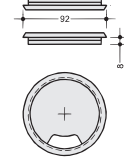

It is possible to provide the cover shelves, side sections, shelves, etc, in units from nearly all the hülsta living room ranges with cable apertures so it is easier to feed cables of electronic equipment through these units. There are four different types of cable apertures to choose from, as listed here. **Please be sure to follow the important notes.**

<p>Cable aperture K1</p> <p>Cable aperture for 80 mm hole, silver colour Standard cable aperture; particularly suitable for cover shelves, side sections and shelves</p> <p>Sizes: Assembly height: 21 mm Outside diameter: 92 mm Inside diameter: 74 mm Diameter of hole: 80 mm</p>  <p style="text-align: center;">K1</p>	<p>Cable aperture K2</p> <p>Cable aperture for 80 mm hole, silver colour particularly suitable for rear walls and side sections</p> <p>Sizes: Assembly height: 8 mm Outside diameter: 92 mm Inside diameter: 74 mm Diameter of hole: 80 mm</p>  <p style="text-align: center;">K2</p>	<p>Cable aperture K3</p> <p>Cable aperture for 60 mm hole, silver colour particularly suitable for shelves and constructional shelves (suitable to an extent for scart cables)</p> <p>Sizes: Assembly height: 21 mm Outside diameter: 72 mm Inside diameter: 54 mm Diameter of hole: 60 mm</p>  <p style="text-align: center;">K3</p>	<p>Cable aperture K20</p> <p>Cable aperture for 80 mm hole, silver colour particularly suitable for side-panels and centre partitions</p> <p>Sizes: Assembly height: 2x 8 mm Outside diameter: 92 mm Inside diameter: 74 mm Diameter of hole: 80 mm</p>  <p style="text-align: center;">K20</p>
--	--	--	--

IMPORTANT NOTES Please be sure to note!
Please be sure to state the **exact position** of the cable aperture in your order (always measure distances from the centre of the cable aperture). For **wall units** the cable aperture is only possible in the bottom position (due to the suspension brackets). With **cover shelves**, the position of the cable aperture is determined in the factory, in accordance with factors specific to the given range. The same applies to technical exceptions because of custom-based planning. The K 20 is positioned in the centre (depthwise) in the **side-panel**. Please state the exact height (centre of hole of cable aperture from bottom rim of side-panel)! Subject to technical progress.

The **minimum distance** for the cable aperture (measured from the inside): 100 mm from the side and 70 mm from the rear (for horizontal surfaces) or 100 mm from the side and 70 mm from the base (for vertical surfaces). Please state if the aperture is to be fitted at the left, at the right or in the centre.

Standard position: If no details of the exact position of the cable aperture are given in your order, the cable aperture is always fitted at the bottom centre or at the rear centre of the relevant surface, whereby the distances stated above still apply.

Caution! Please note that the cable aperture can not be fitted where there is an integrated or front spotlight, centre partitions or a split rear wall. **Please be sure to observe the following explanatory diagrams!**

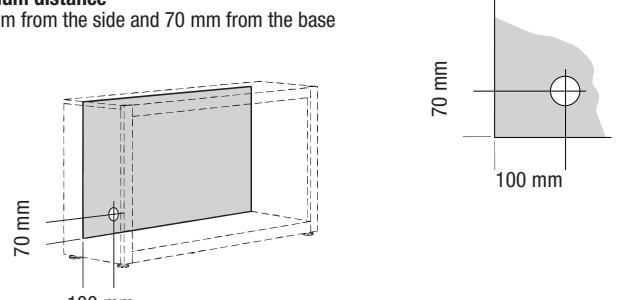
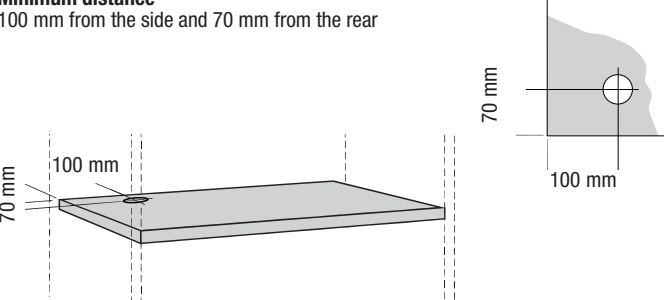
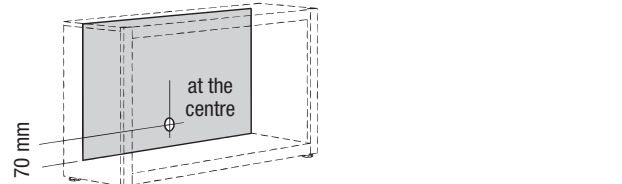
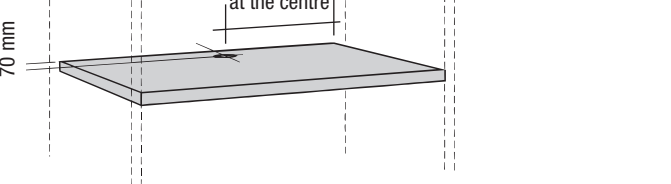
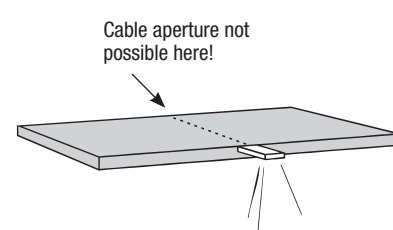
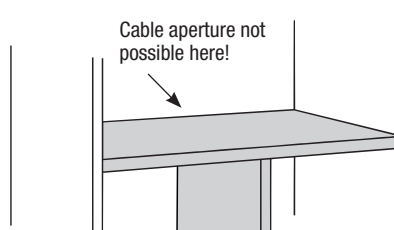
for vertical surfaces	for horizontal surfaces
<p>Minimum distance 100 mm from the side and 70 mm from the base</p> 	<p>Minimum distance 100 mm from the side and 70 mm from the rear</p> 
<p>Standard position at the centre of the surface and 70 mm from the base</p> 	<p>Standard position at the centre of the surface and 70 mm from the rear</p> 
<p>Please note! If there is an integrated or front spotlight in a shelf, for example, the cable aperture cannot be fitted at this position!</p> 	<p>Please note! If there is a centre partition, for example, between two shelves, the cable aperture cannot be fitted at this position!</p> 

Remote control unit with changing colours

The lamps are normally operated by an external footswitch. The colour temperature of the LED lamps is cold white if a footswitch is used. A 4-channel remote control unit is also available as an alternative, which is charged extra. Several lamps can be operated with each of the 4 channels. All 4 channels can be dimmed separately at the push of a button. The colour temperature of all 4 channels can be set to any level from cold white (approx. 6500 kelvin = the basic setting of the LED lamps) to warm white (approx. 2700 kelvin). If warm white is required, a remote control unit must be ordered. It is also possible to switch all channels on and off simultaneously with the "all on" or "all off" buttons. Up to 4 transmitters can operate as many receivers as required. The remote control unit consists of one transmitter and one receiver. If several receivers are required because of the arrangement of the units, these and the corresponding cables are provided ex-works (no surcharge). The footswitch is omitted when the remote control unit is used.

The following points must be noted with the radio remote control unit:

- The receiver must be positioned behind a rear wall or under plinth shelves (at least 20 mm space required under plinth shelves).
- The total wattage power of all lamps included per power supply unit/receiver must not exceed 30 W.
- 4 channels = 4 light groups
- 1 light group = x lights
- All lamps within a light group can be dimmed to the same brightness.
- The same light colour can be set for all lamps in all the light groups. This light colour is then valid for all the lamps.

Please be sure to note the operating and programming instructions!

4-channel remote control unit with changing colours

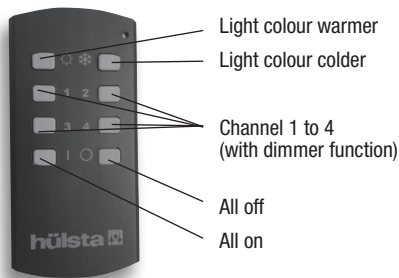

4-channel remote control unit with changing colours

type	2019	-
------	------	---

Examples of use (schematic diagrams)

Example 1

Lights inside a unit

Channel 1 operates (and dims) all the lights in light group 1, i.e. the LED spotlamp in the left cabinet

Channel 2 operates (and dims) all the lights in light group 2, i.e. the LED spotlamps in the open compartment

Channel 3 operates (and dims) all the lights in light group 3, i.e. the LED spotlamp in the right cabinet

Notes:

The total wattage power of all lamps included per power supply unit/receiver must not exceed 30 W. The same light colour can be set for all lamps in all the light groups. This light colour is then valid for all the lamps.

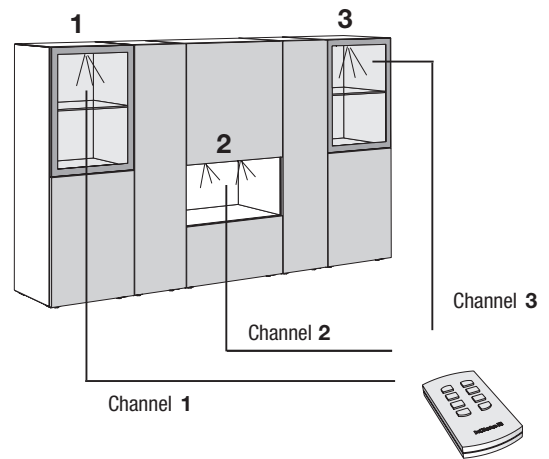

Example 2

Lights in units set apart

Channel 1 operates (and dims) all the lights in light group 1, i.e. the LED spotlamp and the LED light panels in the left cabinet

Channel 2 operates (and dims) all the lights in light group 2, i.e. the LED spotlamps and the LED light panels in the centre cabinet

Channel 3 operates (and dims) all the lights in light group 3, i.e. the LED spotlamp and the LED light panels in the right cabinet

Notes:

The total wattage power of all lamps included per power supply unit/receiver must not exceed 30 W. The same light colour can be set for all lamps in all the light groups. This light colour is then valid for all the lamps.

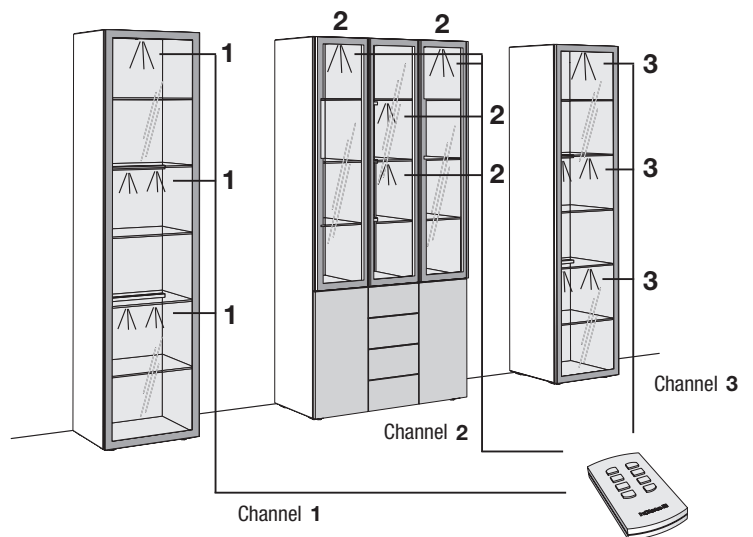

Example 3

Lights in units set apart

Channel 1 operates (and dims) all the lights in light group 1, i.e. the LED spotlamps in the left, centre and right cabinet

Channel 2 operates (and dims) all the lights in light group 2, i.e. the top LED light panels in the left, centre and right cabinet

Channel 3 operates (and dims) all the lights in light group 3, i.e. the bottom LED light panels in the left, centre and right cabinet

Notes:

The total wattage power of all lamps included per power supply unit/receiver must not exceed 30 W. The same light colour can be set for all lamps in all the light groups. This light colour is then valid for all the lamps.

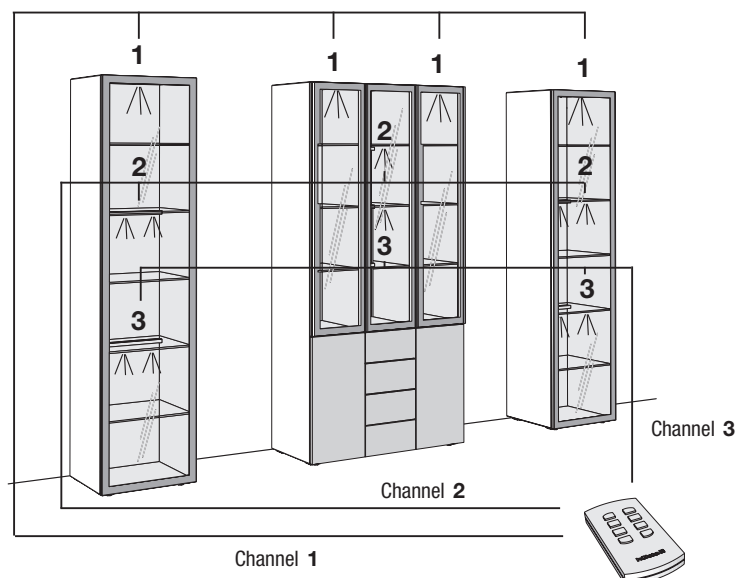

Special-sized products

FENA

Special-sized products are possible on request.
Please get in touch with your customer advisor.

Special articles

Cover panels

for side and top panelling of fitted wardrobes (support construction and fitting materials must be acquired on site).

Basic price per order	9901	-
+ price per m ² lacquer or veneer	990	-

Veneer match with fronts can not be guaranteed.

Individual special-sized products

If the special-sized product that you require is so unusual that it cannot be illustrated with the many special sized products that we already provide and charge for, then we will quote you the price using a HK unit type factor. In your order please state for us the relevant enquiry number and the HK unit type factor stated.

HK -

Special colours; Note on „Blue Angel“ / Emissions label of DGM

Special colours

All the hülsta lacquer colours are possible for nearly all the hülsta ranges.
Availability and prices on request.

Note on „Blue Angel“ (RAL-UZ 38) and Emissions label of DGM (Class A)

It is possible that the requirements of the „Blue Angel“ and the DGM Emissions Label cannot be met by some of the lacquer colours in price groups II and III (see here the different lacquer versions in the NURIA range), depending on the colour mix (surface ratio of these colours in the corresponding order). However, the legal requirements are definitely met in all cases!

Wall composition / assembly instruction

Important notes:

The composition of walls must be ascertained before concluding a contract and be checked by a qualified fitter before assembly takes place.







Assembly may only be carried out by a qualified fitter under careful observation of the assembly instructions.

The plastic Rawl plugs with the type name SX 8 x 65 from the Fischer Company supplied by hülsta as a standard set are only suitable for concrete \geq C12/15, if the wall composition and compression strength corresponds to the table below. Under no circumstances must a unit be assembled on light masonry.

Furthermore, we provide a mounting set with assembly mortar from the Fischer Company for the types of walls listed below (see assembly mortar set below). Again, assembly must be carried out by a qualified fitter under careful observation of the wall composition and assembly instruction. The compression strength levels stated below must be met under all circumstances.

Materials table

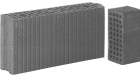
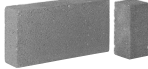
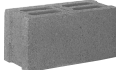
with a description of which sets are to be used with the following types of walls:

Standard set (SX 8 x 65)	Assembly mortar set only suitable for the materials stated below!	
Concrete C12/15 Compression strength \geq 15 N/mm ² 	 Building bricks Mz 12 Compression strength \geq 12 N/mm ²  Limestone blocks KS 12 Compression strength \geq 12 N/mm ²  Perforated sand lime bricks KSL12 Compression strength \geq 12 N/mm ²  Vertically perforated bricks HLz 12 Compression strength \geq 12 N/mm ² Bulk density \geq 1.0 kg/dm ³	 Solid blocks of light concrete V2 Compression strength \geq 2 N/mm ²  Perforated blocks of light concrete Hbl 2 Compression strength \geq 2 N/mm ²  Aerated concrete PP2 Compression strength \geq 2 N/mm ²

A different and more suitable type of mounting must be chosen by a qualified fitter in all other cases. hülsta cannot accept any responsibility for the choice of any other types of mounting! Please note that if the units are not mounted properly on the wall, there is a risk of the units falling down or tipping over – especially when alternative mounting materials acquired on site have been used. Generally speaking, you as a dealer/qualified fitter are responsible for the correct wall mounting of the units.



Mounting sets

Labelling in type list drawings / assembly notes for wall units

The majority of units have two wall mounting points (= number of support boards), if these are to be fitted as wall units. This is not explicitly mentioned in the type list. If a different number of wall mounting points (= support boards) is required, this is marked in the drawings in the type list with numbers in black boxes. Every support board requires four mounting screws.

- 3 = 3 support boards
- 4 = 4 support boards, etc.

One **assembly mortar set** is sufficient for up to a maximum of 3 support boards or 4 wall side-panels.

Important note: Depending on the composition of the wall (see wall types illustrated above), assembly must be carried out using the special assembly mortar set and a standard trade mastic tool which are the basic essentials for safe and clean workmanship.

Standard set

The standard set consists of 4 plastic Rawl plugs (SX 8 x 65) and 4 mounting screws and is sufficient for 1 support board. The standard sets are included in the packet of fittings to match the number of support boards.

Assembly mortar set for up to a maximum of 3 support boards consisting of:

- 9x injection retaining sleeve
- 9x screw-in sleeve
- 1x injection cartridge
- 2x static mixer
- 1x assembly instructions

Please use the mounting screws from the standard set (supplied free of charge).

Example of order:

- Add up number of support boards for all existing unit types
 - Divide the sum by “3”
 - Round up the result to a full number
- = Number of assembly mortar sets required

M2

-

Your Hotline to hülsta

Do you have any questions or require any alterations to your order confirmation?
Do you have any questions on our products or your current order?
Do you have any complaints about supplied goods or required replacement parts?
Contact Telephone: +49 (0) 2563 / 86-1144 • email: orders@huelsta.com

Do you have any questions, suggestions or wishes for the **hülsta Marketing team**
or the **hülsta product seminars**?
Contact Telephone: +49 (0) 2563 / 86-1611 • email: marketing@huelsta.com

hülsta Planning Service

Lots to do? A customer wants his project finished and you haven't got enough time? Or the project is so complex that it will take too much time?

This is exactly the kind of situation we created the hülsta Planning Service for. hülsta's employees create the required project for you at short notice. Based on your information, we implement the project perfectly with all views and a complete order list ready for immediate forwarding to the customer.

The hülsta check list (available at <https://hulsta.com/de/service/showroom/>) makes it all really easy for you. You won't forget anything with this list and the customer receives a project he will be thrilled about as quickly as possible.

hülsta Planning Service

Tel.: +49 (0) 2563 / 86-0

Fax: +49 (0) 2563 / 86-2666

Mail: Planungsservice-Handel@huelsta.de

Workdays from 8.00 a.m. until 6.00 p.m.

Special wishes? Come to us!

Maximum individuality! – Maximal flexibility! – hülsta makes most of your special wishes possible.
And if you do have a wish which is not quite so easy to implement, just give us a call or send us a mail or a fax. We have our own hülsta "Special Wishes Team" who are there to help you realise just these customer requests. These colleagues are professionals when it comes to special products. They plan and calculate the products possible for you and even develop an alternative suggestion if the idea should turn out to be technically impossible.

Here is an overview of the hülsta range of special wishes:

- A lot of special products can be ordered simply via the type list
- Special-sized products are planned simply and professionally
- Competent colleagues advise you by phone, by fax and by mail
- You will be sent alternative suggestions if the idea is technically impossible
- Many special-sized products are available without a surcharge
- Specially qualified carpenters and technicians implement your plans perfectly

hülsta Special Wishes Team

Tel.: +49 (0) 2563 / 86-0

Fax: +49 (0) 2563 / 86-1417

Mail: Sonderwunsch@huelsta.com

We are open Saturdays for you, too!

Our **Saturday hotline** is available all day from **10.00 a.m. until 6.00 p.m.**

Telephone: +49 (0) 2563 / 86-1800

On **working days** the hülsta Sales Department is available all day from **8.00 a.m. until 6.00 p.m.**

hülsta FENA Wohnen

Stand: E 5.2018

Design and concept legally protected, subject to error and alterations to construction, colour and materials by way of technological progress.

hülsta-werke · Karl-Hüls-Straße 1 · D-48703 Stadtlohn
Tel. +49 (0) 2563 / 86-0 · Fax +49 (0) 2563 / 86-1000
www.huelsta.com

hülsta 
Die Möbelmarke.