

Aunis

6/19

E

Type list

LIVING



AUNIS

NEW range

Contents

	Page
Range introduction, lists of versions, important notes	2-3
Suggested combinations	4-5
Lowboards	6-7
Media accessories for lowboards	8-9
Sideboards, highboards, cabinet	10-11
Wall units	12
Glass rear walls for low-, side-, highboards, cabinet and wall units	13
Bookshelves, glass rear walls for bookshelves	14
Accessories for units, lamps	16-17
Dining, coffee tables	18
General information:	
Special-sized products, special articles	19
Switch options for lamps	20-21
Important notes: quality of walls / assembly instruction	22

Urban nature

AUNIS follows an exciting concept: it combines urbanity and natural in a stunning designer line. Simplistic yet sophisticated, this ground-breaking design sets the benchmark for clever space optimisation with a stylish look. AUNIS is made for living, dining and life.

Efficient design

Its compact yet elegant shape featuring a tapered carcass gives AUNIS its unmistakable look. It effortlessly masters architectural challenges, as this concept makes the most of limited space. Smart sliding-doors add to the efficient use of the available space.

Beautiful solid wood

The charismatic design combines the elegant solid wood fronts with stunning glass inserts and distinctive lacquer accents. Depending upon personal taste, simply combine the warmth of natural oak or the elegance of walnut with cool anthracite structured lacquer.

Great variety

AUNIS places chests featuring asymmetrically positioned glass next to generous glass cabinets and wall-mounted units that are true eye-catchers. The concept also includes an interesting interlinking between units, such as the lines of the glass cabinet compartments, which are cleverly repeated in the shape of the fitted shelves.

Plenty of comfort

As an urban range, the multi-functional AUNIS offers sophisticated technical equipment such as the practical IR-repeater. LED lighting with colour change, which can be integrated and remote controlled, creates the perfect ambience for every mood.

Lists of versions

Model no.	Exterior carcass and front / cover shelf	Price group	Model no.	Accent front, cover shelf
801	Solid natural oak rough look / Natural oak rough look	I	665	Anthracite structured lacquer
803	Solid walnut / Core walnut	II		

Interior carcass, interior fittings and bookshelf rear wall always in grey lacquer

Important notes

Glass versions:

Glass fronts and fitted glass shelves behind fronts of grey stained glass.
Optional glass rear wall of low-, side-, highboards, cabinet, wall units and bookshelves of satinised glass, anthracite rear-lacquered.

Rear walls:

Rear walls of low-, side-, highboards, cabinet, wall units and bookshelves in grey lacquer.
Units with glass section and bookshelves optionally available with glass rear walls (of satinised glass, anthracite rear-lacquered).

Cover shelves:

Cover shelves optionally in wooden version (veneer) or in anthracite structured lacquer.

Standard interior fittings:

Fitted wooden shelves are fitted behind doors at 2 Raster intervals and fitted glass shelves are fitted behind glass doors.

Wall units:

If units are planned as wall units, a wall bracket must be ordered.
Wall units always incl. wall bracket.

Drawer frames in grey

Combinations of floor and wall units:

If floor and wall units are combined within an arrangement, there must not be any skirting boards in the room near the floor units, otherwise they must be removed.

Max. load:

Max. load of wooden and glass shelves (up to 70.4 cm width) as well as drawers: 25 kg
Max. load of wooden and glass shelves (between 70.4 and 105.6 cm width): 15 kg;
from 105.6 cm width: 10 kg
Max. load of cover shelves: 35 kg per metre length for floor units. Please also note any maximum loads which may be stated in the type list for the individual units!

hülsta-SoftFlow: Drawers on hidden bearings incl. auto pull-in feature with brake as fully pull-out units

hülsta-MagicClose: All wooden hinge-doors with door cushioning system

Interior fittings of low- and sideboards

Interior fittings of low- and sideboards:

Behind the outer hinge-door of low- and sideboards there is 1 fitted shelf and in the compartment behind the glass sections of the drawers there is 1 metal support, 1 partition as well as 1 constructional shelf, resp. behind the sliding-door there is 1 constructional shelf.

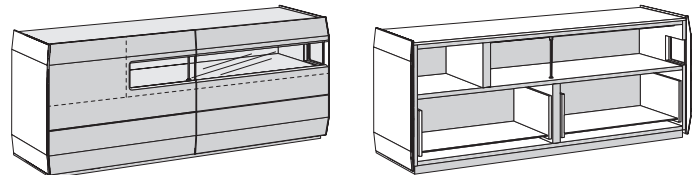

Wall units

If lowboards are included as wall units, a maximum load per unit of 15 kg per metre must not be exceeded for reasons of stability! Max. load 15 kg per metre:

144.6 cm width: 20 kg
179.8 cm width: 25 kg
215.0 cm width: 30 kg
232.6 cm width: 30 kg
267.8 cm width: 35 kg

The wall units can only be fitted on absolutely solid walls. Light masonry is not suitable for this purpose.

For each project please remember to leave a 2.0 cm gap at the top to be able to mount units.

Labelling in type list drawings / assembly notes for wall units

Labelling in type list drawings / assembly notes for wall units

The majority of units have two wall mounting points (= number of base plates), if these are to be fitted as wall units. This is not explicitly mentioned in the type list. If a different number of wall mounting points (= base plates) is required, this is marked in the drawings in the type list with numbers in black boxes. Please be sure to note here the information and notes in the "Wall composition" chapter!

3
4

Notes on delivery

Notes on delivery:

The majority of the units are delivered standard as **fully connected units (glued)** so that the carcass **cannot be disassembled**. There are however some **exceptions** to this rule:

Some carcasses are delivered as complete units but can be **disassembled into individual sections** in the final customer's home. These types are marked with a **1** in the type list.

Some carcasses are delivered **in individual sections** because of their size. These types are marked with a **2** in the type list.

The fronts with the number **2** are delivered separately and can therefore always be (dis-) assembled.

Wall fitting

Important notes: Generally speaking, you as a dealer/qualified fitter are responsible for the correct wall mounting of the units. That is why wall mounting should only be carried out by properly trained and qualified fitters. hülsta supplies materials for mounting units on walls for nearly all the units and which should be used for safety and for constructional reasons. The assembly materials supplied by hülsta (plugs, screws) are only suitable for fitting components on to concrete in firmness class C12/15.

For other materials (please see separate materials table in the wall composition chapter) we provide you with an assembly mortar set as an extra order. Please note that this assembly mortar set is also only suitable for the materials listed in the materials table. If walls are made up of other materials (e.g. plastered or lighter wall materials), one should use another method of mounting better suited to the load on site. Please note that if the units are not mounted properly on the wall, there is a risk of the units falling down or tipping over – especially when alternative mounting materials acquired on site have been used. For the reasons stated above it is absolutely essential to enquire about the composition of any walls before signing any contracts.

Suggested combinations

Dark grey shading in the sketches = Components in accent versions

As an alternative to planning an individual unit from the complete range there is the possibility of choosing from specially suggested combinations. This eases planning. Incorporating accessories can enhance the suggested combinations. These are charged extra.

<p>as illustr. v. versa</p> <p>Price gr. I II</p>	<p>980001 980101</p> <p>-</p>	<p>980002 980102</p> <p>-</p>
<p>as illustr. v. versa</p> <p>Price gr. I II</p>	<p>980003</p> <p>-</p>	<p>980004 980104</p> <p>-</p>
<p>as illustr. v. versa</p> <p>Price gr. I II</p>	<p>980005 980105</p> <p>-</p>	<p>980006 980106</p> <p>-</p>

Suggested combinations

As an alternative to planning an individual unit from the complete range there is the possibility of choosing from specially suggested combinations. This eases planning. Incorporating accessories can enhance the suggested combinations. These are charged extra.

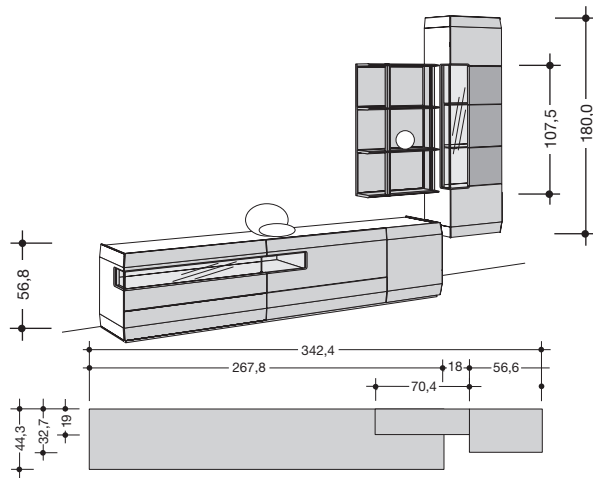

as illustr.
v. versa

980007
980107

Price gr.

-
-

Lowboards

Dark grey shading in the sketches = Components in accent versions

Lowboards
56.8 cm high
(58.6 cm high incl. 1.8 cm high plinth),
44.3 cm deep

Bottom drawers with handle recess

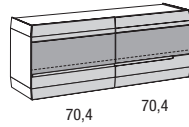

144.6 cm wide

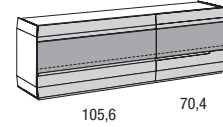

179.8 cm wide

	4 drawers	4 drawers	
as illustr. v. versa	314111 314112	317111 317112	
Price gr. I	-	-	
II	-	-	

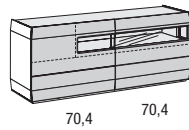

144.6 cm wide

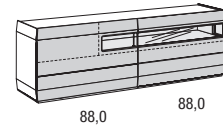

179.8 cm wide

	2 drawers with glass section	2 drawers with glass section	
as illustr. v. versa	314211 314212	317211 317212	
Price gr. I	-	-	
II	-	-	

When used as wall units:
Max. load per unit: 40 kg

Wall bracket
If units are planned as wall units, a wall bracket must be ordered.

	4144	4179	
	-	-	

Notes on delivery:
Please see here the information on range introduction pages.

Assembly notes for wall units:
Please be sure to note here the information and notes in the "Wall composition" chapter!

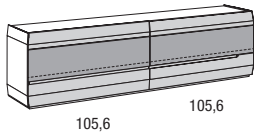

215.0 cm wide

4 drawers

321111
321112

-
-

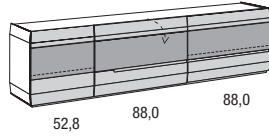

232.6 cm wide

1 door; 1 flap; 3 drawers

323111
323112

-
-

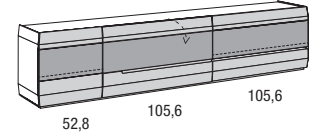

267.8 cm wide

1 door; 1 flap; 3 drawers

326111
326112

-
-

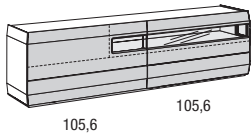

215.0 cm wide

2 drawers with glass section

321211
321212

-
-

4215

-

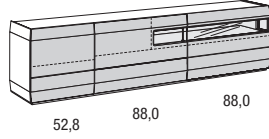

232.6 cm wide

1 door; 2 drawers with glass section

323211
323212

-
-

4232

-

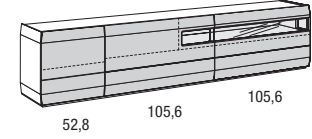

267.8 cm wide

1 door; 2 drawers with glass section

326211
326212

-
-

4267

-

Media accessories for lowboards

IR repeater set

IR repeater set

Infrared signal transmission set for operating media units behind wooden/lacquered fronts. You can operate all the units in one compartment with one set. The following applies:

- One set must be used in each compartment. 2 transmitters can also be installed in large compartments in order to increase performance. In this case only one additional transmitter needs to be ordered.
- The transmitter must be placed in the direct vicinity of the receiver eye.
- Transmittable IR frequency band 20 – 60 kHz
- Up to 3 transmitters can be combined with one receiver.

It is possible to use 3 transmitters via 1 receiver including Master box. This enables simultaneous operation of 3 different furniture compartments or in critical situations it allows fitting out one furniture compartment with several transmitters in order to increase the performance in this compartment or to operate 2 end units placed next to one another.

The IR repeater set consists of:

- 1 receiver eye (Ø 3.0 cm) incl. standing bracket
- 1 electrical transmitter
- 1 plug EVG 12 V
- Cable clips

Please note the details stated in the operating instructions!

IR repeater set
1 receiver eye and 1 transmitter incl. standing bracket

2001

-

Extra transmitter

2003



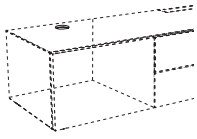
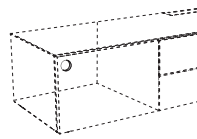
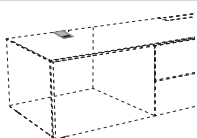
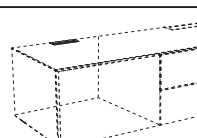
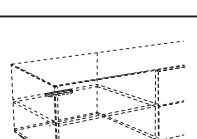
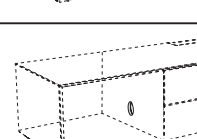

-

Cable apertures

The cable apertures K2 and K8 are not possible, when glass rear walls are fitted in the lowboards!

	<p>Cable aperture K1 silver-coloured; Ø 8.0 cm; It is possible to fit a cable aperture in the top shelf of the lowboard. The cable aperture can be made at the rear of the top shelf. The position is in the centre of the compartment, distance from centre of aperture to rear edge of unit: 10.0 cm.</p>	<p>K1 -</p>
	<p>Cable aperture K2 silver-coloured; Ø 8.0 cm; It is possible to fit a cable aperture in the rear wall of the lowboard. Positioned at centre of compartment.</p>	<p>K2 -</p>
	<p>Cable aperture K7 silver-coloured; 7.0 x 12.0 cm; It is possible to fit a cable aperture in the top shelf of the lowboard. The position is in the centre of the compartment, flush with the rear edge of the unit.</p>	<p>K7 -</p>
	<p>Cable aperture K8 silver-coloured; 12.8 x 3.2 cm; It is possible to fit a cable aperture in the top shelf of the lowboard. The cable aperture can be made at the rear rim of the top shelf. Positioned in centre of compartment.</p>	<p>K8 -</p>
	<p>Cable aperture K9 13.0 x 1.6 cm; It is possible to fit a cable aperture in a fitted shelf. The cable aperture can be made at the rear rim of the fitted shelf. Positioned in centre of compartment.</p>	<p>K9 -</p>
	<p>Cable aperture K20 silver-coloured; Ø 8.0 cm; It is possible to fit a cable aperture in the partitions of the lowboard.</p>	<p>K20 -</p>

Column system, flat screen supports

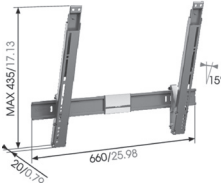
<p>Column system consisting of a metal column (for fitting anywhere on wall) and of audio/DVD support(s), for fitting anywhere on column.</p> <p>Example of use:</p> 	<p>Columns of metal; for fitting anywhere on walls above top rim of plinth slot; cables can be laid and hidden at any height; audio/DVD supports can be fitted anywhere on the column.</p>  <table border="1" data-bbox="574 553 1050 668"> <tr> <td>36.8 cm high</td> <td>64.1 cm high</td> </tr> <tr> <td>9201</td> <td>9202</td> </tr> <tr> <td>-</td> <td>-</td> </tr> </table>	36.8 cm high	64.1 cm high	9201	9202	-	-	<p>Audio/DVD support of metal; can be positioned at any height on the column and be adjusted to suit audio/DVD players of any size; with rubber padding at front to prevent units from slipping; max. load: 10 kg</p>  <p style="text-align: center;">9203</p> <p style="text-align: center;">-</p>
36.8 cm high	64.1 cm high							
9201	9202							
-	-							
<p>Flat screen support WTL6 The flat screen support can be adjusted 3-dimensionally. It is suitable for flat screens with a screen diagonal of 102-216 cm (40"-85"); max. load: 45 kg. Suitable for Curved TV's. Flat screen support compatible with VESA Norm standard: min.: 200 x 200 mm max.: 600 x 400 mm</p> 	<p>Flat screen support THIN 345, ideally adaptable The flat screen support can be adjusted 3-dimensionally. It is suitable for flat screens with a screen diagonal of 81-140 cm (32"-55") and a maximum depth of 4.5 cm; max. load: 25 kg. Go to www.vogels.com to check if your flat screen can be fitted on this flat screen support. Enter the name THIN 345. After a few steps you can see if your flat screen TV is compatible with the flat screen support. Not suitable for Curved TV's. Flat screen support compatible with VESA Norm standard: min.: 100 x 100 mm max.: 600 x 400 mm</p> 	<p>Flat screen support THIN 315 The flat screen support can be angled up to a max. 15°. It is suitable for flat screens with a screen diagonal of 102-165 cm (40"-65") and a maximum depth of 5.0 cm; max. load: 25 kg. Go to www.vogels.com to check if your flat screen can be fitted on this flat screen support. Enter the name THIN 315. After a few steps you can see if your flat screen TV is compatible with the flat screen support. Not suitable for Curved TV's. Flat screen support compatible with VESA Norm standard: min.: 100 x 100 mm max.: 600 x 400 mm</p> 						
<p style="text-align: center;">for fitting anywhere on walls</p>	<p style="text-align: center;">for fitting anywhere on walls</p>	<p style="text-align: center;">for fitting anywhere on walls</p>						
<p style="text-align: center;">9704</p> <p style="text-align: center;">-</p>	<p style="text-align: center;">9304</p> <p style="text-align: center;">-</p>	<p style="text-align: center;">9504</p> <p style="text-align: center;">-</p>						

Sideboards

Dark grey shading in the sketches = Components in accent versions

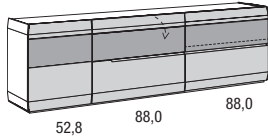
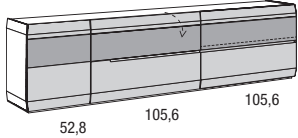
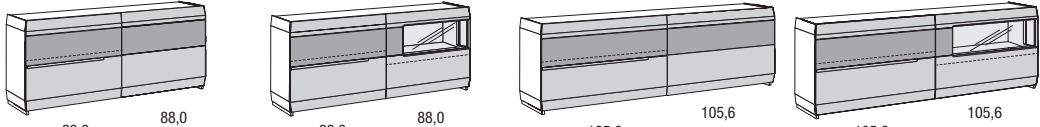
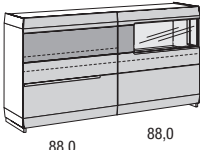
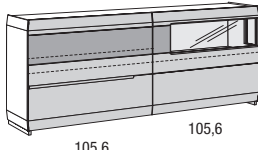
<p>Sideboards 76.2 cm high (incl. 1.8 cm high plinth), 44.3 cm deep</p> <p>Bottom drawers with handle recess</p>	 <p>232.6 cm wide</p>		 <p>267.8 cm wide</p>					
	<p>1 door; 1 flap; 3 drawers</p>		<p>1 door; 1 flap; 3 drawers</p>					
<p>as illustr. v. versa</p> <p>Price gr. I II</p>	<p>423111 423112</p> <p>- -</p>		<p>426111 426112</p> <p>- -</p>					
<p>Sideboards with sliding-door 77.9 cm high (incl. 3.5 cm high plinth), 44.3 cm deep</p> <p>Bottom drawer with handle recess</p>								
	<p>2 drawers; 1 sliding-door</p>		<p>2 drawers; 1 sliding-door with glass section</p>		<p>2 drawers; 1 sliding-door</p>		<p>2 drawers; 1 sliding-door with glass section</p>	
<p>as illustr. v. versa</p> <p>Price gr. I II</p>	<p>417111 417112</p> <p>- -</p>		<p>417211 417212</p> <p>- -</p>		<p>421111 421112</p> <p>- -</p>		<p>421211 421212</p> <p>- -</p>	
<p>Sideboards with sliding-door 95.5 cm high (incl. 3.5 cm high plinth), 44.3 cm deep</p> <p>Bottom two drawers with handle recess</p>	 <p>179.8 cm wide</p>		 <p>215.0 cm wide</p>					
	<p>3 drawers; 1 sliding-door with glass section</p>		<p>3 drawers; 1 sliding-door with glass section</p>					
<p>as illustr. v. versa</p> <p>Price gr. I II</p>	<p>517211 517212</p> <p>- -</p>		<p>521211 521212</p> <p>- -</p>					

Highboards

AUNIS

<p>Highboards 146.6 cm high (incl. 1.8 cm high plinth), 44.3 cm deep</p>				
	<p>Illustr.: </p>			
	<p>1 door; 1 door with glass section 2 doors with glass section 2 doors; 1 door with glass section 1 door with glass section left and right; 1 door</p>			
	<p>as illustr. v. versa</p>	<p>810211 810212</p>	<p>81031</p>	<p>814211 814212</p>
<p>Price gr. I II</p>	<p>- -</p>	<p>- -</p>	<p>- -</p>	<p>- -</p>

Cabinet

<p>Cabinet 199.4 cm high (incl. 1.8 cm high plinth), 44.3 cm deep</p> <p>Door with handle in anthracite structured lacquer</p>				
	<p>1 door with glass section</p>			
	<p>Price gr. I II</p>	<p>115111 L 115112 R</p> <p>- -</p>		

Assembly notes for wall units:
Please be sure to note here the information and notes in the "Wall composition" chapter!

3
4

Dark grey shading in the sketches = Components in accent versions

Wall units

Wall units
74.4 cm high,
32.3 cm deep

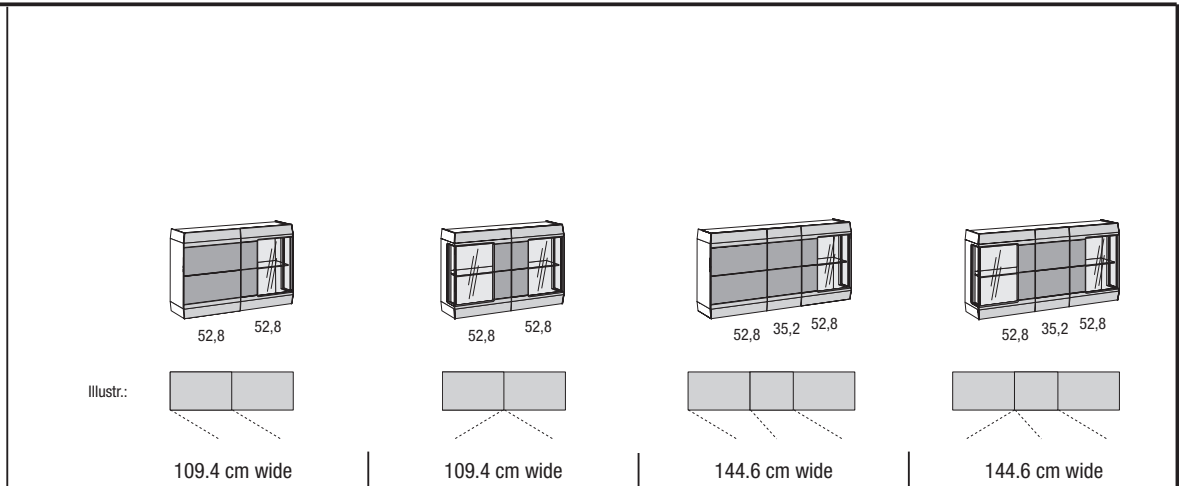

	109.4 cm wide	109.4 cm wide	144.6 cm wide	144.6 cm wide
as illustr. v. versa	1 door; 1 door with glass section	2 doors with glass section	2 doors; 1 door with glass section	1 door with glass section left and right; 1 door
	310511 310512	31061	314511 314512	314611 314612
Price gr.	-	-	-	-
I	-	-	-	-
II	-	-	-	-

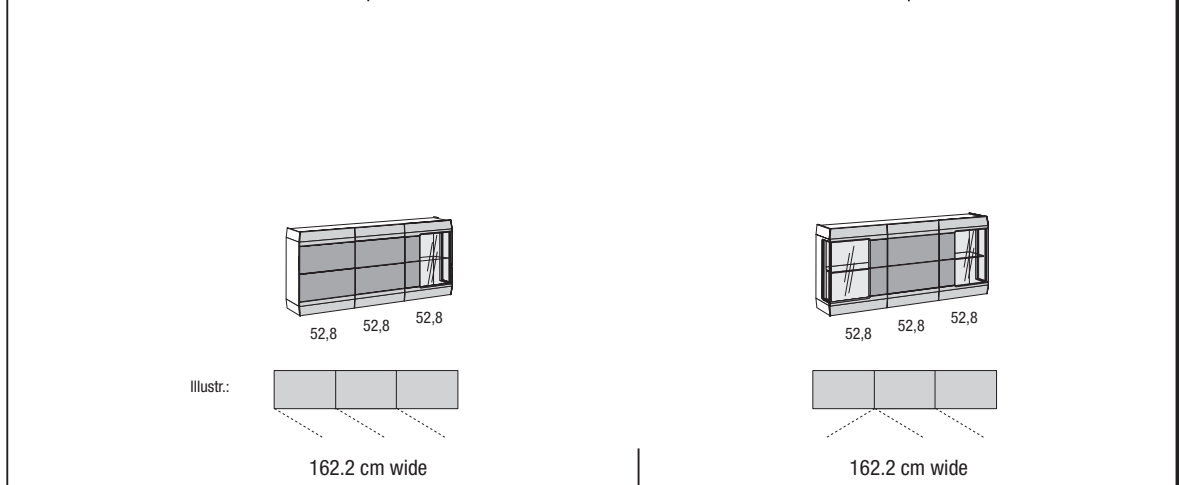

	162.2 cm wide	162.2 cm wide
as illustr. v. versa	2 doors; 1 door with glass section	1 door with glass section left and right; 1 door
	416511 416512	416611 416612
Price gr.	-	-
I	-	-
II	-	-

Max. load: 40 kg

Wall units
144.8 resp. 180.0 cm high,
32.3 cm deep

Door with handle in anthracite structured lacquer

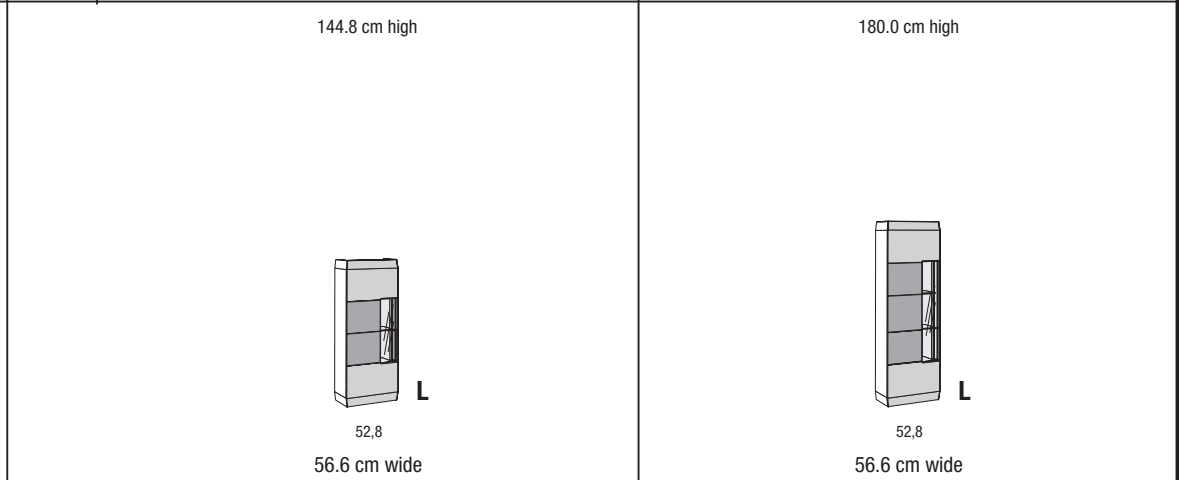

	144.8 cm high	180.0 cm high
Price gr.	1 door with glass section	1 door with glass section
	85511 L 85512 R	105511 L 105512 R
I	-	-
II	-	-

Max. load: 40 kg

Rear wall behind glass section in glass version

Rear wall behind glass section in glass version

The rear walls behind the glass sections of low-, side-, highboards, cabinet and wall units are optionally available in glass version (satinised glass, anthracite rear-lacquered).

Later fitting is possible.

for lowboards

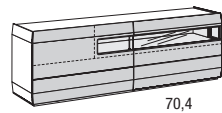

70,4

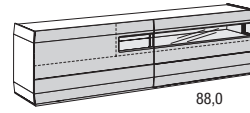

88,0

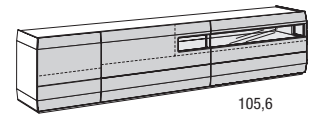

105,6

119

-

129

-

139

-

for sideboards

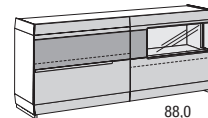

88,0

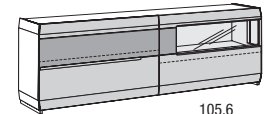

105,6

219

-

229

-

for highboards and wall units



52,8

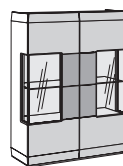

52,8 52,8

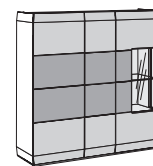

52,8

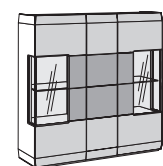

52,8 52,8

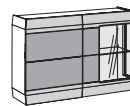

52,8

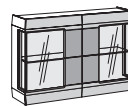

52,8 52,8

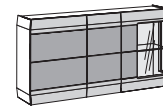

52,8

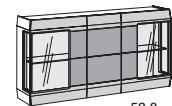

52,8 52,8

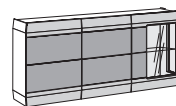

52,8

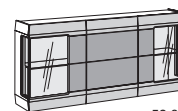

52,8 52,8



52,8

419

-

for cabinet type 115111 L / 115112 R



52,8

429

-

for wall unit type 105511 L / 105512 R



52,8

619

-

Assembly notes for wall units:
 Please be sure to note here the information and notes in the "Wall composition" chapter!

3
4

Dark grey shading in the sketches = Components in accent versions

Bookshelves

<p>Extension bookshelves 72.3 resp. 107.5 cm high, 19.0 cm deep</p> <p>Bookshelves for extending other (wall) units at one side</p> <p>with shelves in wood version and rear wall in grey lacquer; with metal supports in anthracite structured lacquer on the outer side</p> <p>Wall fitting absolutely necessary</p>	72.3 cm high		107.5 cm high	
	70.4 cm wide	105.6 cm wide	70.4 cm wide	105.6 cm wide
as illustr. v. versa	47011 47012	41011 41012	67011 67012	61011 61012
Price gr.	-	-	-	-
I	-	-	-	-
II	-	-	-	-
Max. load: 15 kg				
<p>Free-hanging bookshelves 72.3 resp. 107.5 cm high, 19.0 cm deep</p> <p>Bookshelves for fitting anywhere on walls</p> <p>with shelves in wood version and rear wall in grey lacquer; with metal supports in anthracite structured lacquer on both outer sides</p>	72.3 cm high		107.5 cm high	
	105.6 cm wide	140.8 cm wide	140.8 cm wide	
Price gr.	4102	4142	6142	
I	-	-	-	
II	-	-	-	
Max. load: 15 kg				



Bookshelf rear wall in glass version

<p>Bookshelf rear wall in glass version</p> <p>The bookshelf rear walls are optionally available in glass version (satinised glass, anthracite rear-lacquered).</p> <p>Later fitting is not possible.</p>				
	for 70.4 cm width	for 105.6 cm width	for 70.4 cm width	for 105.6 cm width
	4719	4119	6719	6119
	-	-	-	-
	for 105.6 cm width	for 140.8 cm width	for 140.8 cm width	
	4729	4129	6129	
	-	-	-	



Accessories for units

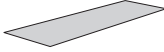

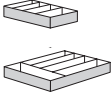
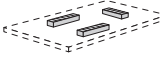

Accessories for drawers

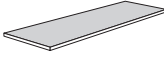
		for 70.4 cm width	for 88.0 cm width	for 105.6 cm width
 <p>Tableau lined with grey fabric</p>				
		8620 -	8621 -	8622 -
 <p>CD holder for drawers Please state exactly in your order and drawing in which 2 Raster drawer the CD holder is to be fitted.</p>				
		8420 -	8421 -	8422 -
 <p>DVD/Blu-Ray holder for drawers Please state exactly in your order and drawing in which 2 Raster drawer the DVD/Blu-Ray holder is to be fitted.</p>				
		8320 -	8321 -	8322 -
 <p>Cutlery box of metal, lined with grey fabric inside; incl. compartments</p>		17.6 cm wide	35.2 cm wide	
		855 -	856 -	
 <p>Cutlery holder lined with grey fabric, for fitting in drawers</p> <p>Set 1: for 60 pieces of cutlery Set 2: for 17 serving utensils</p>		Set 1: for standard cutlery like spoons, forks, knives, etc.	Set 2: for sauce ladles, cake forks, cake servers, etc.	
		116 -	117 -	

Fitted shelves

		for 35.2 cm width	for 52.8 cm width	for 88.0 cm width	for 105.6 cm width
 <p>Fitted shelf 1.9 cm thick</p>	for 32.7 cm depth	133 -	153 -	X	X
	for 44.3 cm depth	134 -	154 -	184 -	1104 -

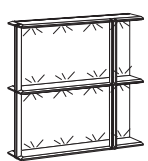
Lamps

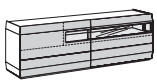
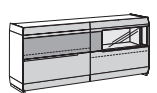
This luminaire contains built-in LED lamps of the energy classes A++ to A. The lamps cannot be changed in the luminaire. 12 V		LED lamps incl. footswitch. A remote control unit is possible for operation (against a surcharge).								
 <p>Integrated LED spotlight Ø 7.1 cm; for fitting in units Later fitting is not possible.</p>	2.9 W									
	7941 -									
 <p>LED light panel 1.9 cm thick, 3.0 cm deep; for fitting under glass shelves Later fitting is not possible.</p> <p>under glass shelves</p>	for 52.8 cm width									
	3.5 W									
 <p>LED bookshelf lamps Later fitting is not possible.</p>		for 70.4 cm width		for 105.6 cm width		for 140.8 cm width				
		5.1 W		7.9 W		10.3 W				
		475 -		4105 -		4145 -				
		5.1 W		7.9 W		10.3 W				
for 105.6 cm height		675 -		6105 -		6145 -				
 <p>LED light strip for fitting in the compartment behind the glass section of drawers resp. sliding-door Later fitting is not possible.</p>  	for 144.6 cm width		for 179.8 cm width		for 215.0 cm width		for 232.6 cm width		for 267.8 cm width	
	7.1 W		8.2 W		9.8 W		8.2 W		9.8 W	
	4106 -		4186 -		4136 -		4186 -		4136 -	
	for fitting in the compartment behind sliding-door		5.9 W		7.1 W		-		-	
for fitting in the compartment behind sliding-door		486 -		4106 -		-		-		

Radio remote control with change of colour temperature

The lamps are normally operated by an external foot switch. The colour temperature of the LED lamps is cold white if a foot switch is used. A 4-channel radio remote control is also available as an alternative, which is charged extra. Several lamps can be operated with each of the 4 channels. All 4 channels can be dimmed separately at the push of a button. The colour temperature of all 4 channels can be set to any level from cold white (approx. 6500 kelvin = the basic setting of the LED lamps) to warm white (approx. 2700 kelvin). If warm white is required, a radio remote control must be ordered. It is also possible to switch all channels on and off simultaneously with the "all on" or "all off" buttons. The radio remote control consists of one transmitter and one receiver. If several receivers are required because of the arrangement of the units, these and the corresponding cables are provided ex-works (no surcharge). The foot switch is omitted when the radio remote control is used.



2119

-

DINING Dining tables and chairs

DINING

hülsta offers a room concept to meet all requirements in comfort, beauty of form and attractiveness with a comprehensive collection of dining room tables and chairs.

The **dining tables** in a wide variety of sizes (with and without pullout function) in all wood surface versions and in contemporary designs, as well as the **dining chairs** that can be combined individually using different armrests, comfort features, high-grade cover fabrics (leather, textiles) and metal surfaces can all be found in the **"DINING"** type list.



Coffee tables CT 220

Coffee tables CT 220

The diagonal millings of the CT 220 create a dynamic overall look. The solid wooden versions natural oak and walnut highlight the natural yet elegant feel. Strong accents in anthracite structured lacquer provide an excellent contrast.

You will find the coffee table CT 220 as well as other coffee tables in the **"Coffee tables"** type list.



Coffee tables

Coffee tables

hülsta offers a comprehensive **collection of coffee tables**, which not only match the hülsta furniture ranges perfectly but can also be combined with other products that are available on the market. You will find these coffee tables in a number of designs, sizes and versions in the **"Coffee tables"** type list.



AUNIS

Special-sized products are possible on request.
Please get in touch with your customer advisor.

Special articles

Cover panels

for side and top panelling of fitted wardrobes (support construction and fitting materials must be acquired on site).

Basic price per order	9901	-
+ price per m ² lacquer or veneer	990	-

Veneer match with fronts can not be guaranteed.

Individual special-sized products

If the special-sized product that you require is so unusual that it cannot be illustrated with the many special sized products that we already provide and charge for, then we will quote you the price using a HK unit type factor. In your order please state for us the relevant enquiry number and the HK unit type factor stated.

HK -

Special colours; Note on „Blue Angel“ / Emissions label of DGM

Special colours

All the hülsta lacquer colours are possible for nearly all the hülsta ranges.
Availability and prices on request.

Note on „Blue Angel“ (RAL-UZ 38) and Emissions label of DGM (Class A)

It is possible that the requirements of the „Blue Angel“ and the DGM Emissions Label cannot be met by some of the lacquer colours in price groups II and III (see here the different lacquer versions in the NURIA range), depending on the colour mix (surface ratio of these colours in the corresponding order). However, the legal requirements are definitely met in all cases!

Switch options for lamps: Radio remote control with change of colour temperature

Radio remote control with change of colour temperature

The lamps are normally operated by an external foot switch. The colour temperature of the LED lamps is cold white if a foot switch is used. A 4-channel radio remote control is also available as an alternative, which is charged extra. Several lamps can be operated with each of the 4 channels. All 4 channels can be dimmed separately at the push of a button. The colour temperature of all 4 channels can be set to any level from cold white (approx. 6500 kelvin = the basic setting of the LED lamps) to warm white (approx. 2700 kelvin). If warm white is required, a radio remote control must be ordered. It is also possible to switch all channels on and off simultaneously with the "all on" or "all off" buttons. The radio remote control consists of one transmitter and one receiver. If several receivers are required because of the arrangement of the units, these and the corresponding cables are provided ex-works (no surcharge). The foot switch is omitted when the radio remote control is used.

The following points must be noted with the radio remote control:

- The receiver must be positioned behind a rear wall or under plinth shelves (at least 20 mm space required under plinth shelves).
- The total wattage power of all lamps included per receiver must not exceed 30 W.
- 4 channels = 4 light groups
- 1 light group = x lights
- All lamps within a light group can be dimmed to the same brightness.
- The change of the colour temperature takes place for all lamps in all light groups.
- The radio remote control is not suitable for equipment operating on 110 V.

Please be sure to note the operating and programming instructions!

4-channel radio remote control with change of color temperature



4-channel radio remote control with change of color temperature

Type	2119	-
------	------	---

Examples of use (schematic diagrams)

Example 1

Lights inside a unit

Channel 1 operates (and dims) all the lights in light group 1, i.e. the LED spotlamp in the left cabinet

Channel 2 operates (and dims) all the lights in light group 2, i.e. the LED spotlamps in the open compartment

Channel 3 operates (and dims) all the lights in light group 3, i.e. the LED spotlamp in the right cabinet

Notes:

The total wattage power of all lamps included per receiver must not exceed 30 W. The change of the colour temperature takes place for all lamps in all light groups.

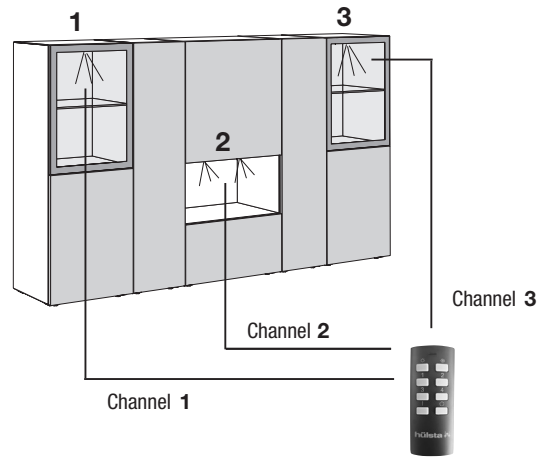

Example 2

Lights in units set apart

Channel 1 operates (and dims) all the lights in light group 1, i.e. the LED spotlamp and the LED light panels in the left cabinet

Channel 2 operates (and dims) all the lights in light group 2, i.e. the LED spotlamps and the LED light panels in the centre cabinet

Channel 3 operates (and dims) all the lights in light group 3, i.e. the LED spotlamp and the LED light panels in the right cabinet

Notes:

The total wattage power of all lamps included per receiver must not exceed 30 W. The change of the colour temperature takes place for all lamps in all light groups.

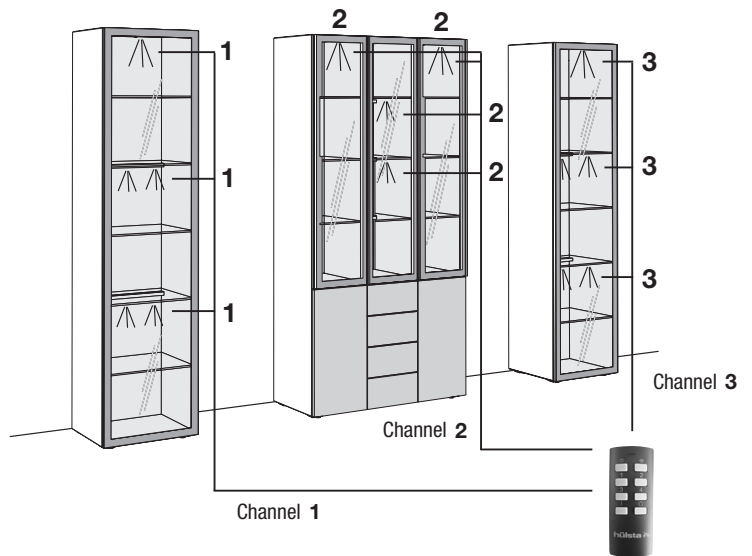

Example 3

Lights in units set apart

Channel 1 operates (and dims) all the lights in light group 1, i.e. the LED spotlamps in the left, centre and right cabinet

Channel 2 operates (and dims) all the lights in light group 2, i.e. the top LED light panels in the left, centre and right cabinet

Channel 3 operates (and dims) all the lights in light group 3, i.e. the bottom LED light panels in the left, centre and right cabinet

Notes:

The total wattage power of all lamps included per receiver must not exceed 30 W. The change of the colour temperature takes place for all lamps in all light groups.

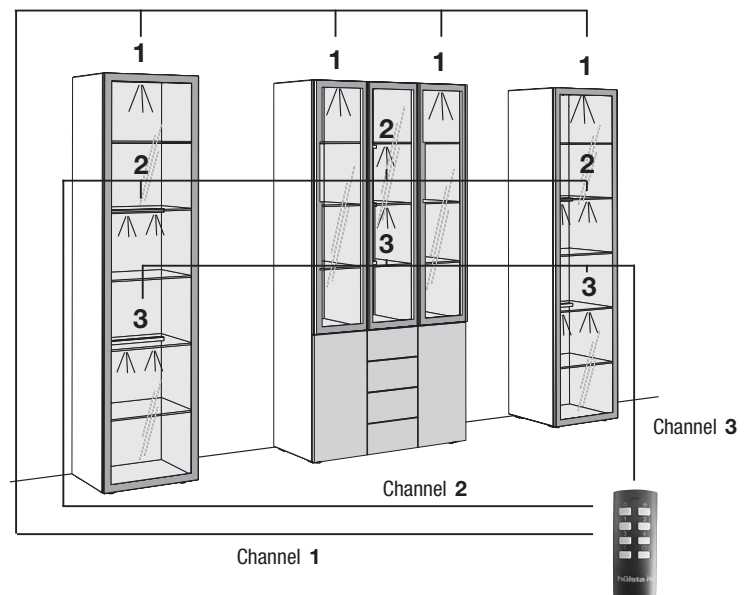

Important notes

Wall composition / assembly instruction

Important notes:

The composition of walls must be ascertained before concluding a contract and be checked by a qualified fitter before assembly takes place.







Assembly may only be carried out by a qualified fitter under careful observation of the assembly instructions.

The plastic Rawl plugs supplied by hülsta as a standard set are only suitable for concrete $\geq C12/15$, if the wall composition and compression strength corresponds to the table below. Under no circumstances must a unit be assembled on light masonry.

Furthermore, we provide a mounting set with assembly mortar for the types of walls listed below (see assembly mortar set below). Again, assembly must be carried out by a qualified fitter under careful observation of the wall composition and assembly instruction. The compression strength levels stated below must be met under all circumstances.

Materials table

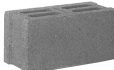
with a description of which sets are to be used with the following types of walls:

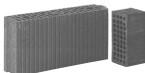
Standard set	Assembly mortar set only suitable for the materials stated below!	
Concrete C12/15 Compression strength $\geq 15 \text{ N/mm}^2$ 	 Building bricks Mz 12 Compression strength $\geq 12 \text{ N/mm}^2$	 Solid blocks of light concrete V2 Compression strength $\geq 2 \text{ N/mm}^2$
	 Limestone blocks KS 12 Compression strength $\geq 12 \text{ N/mm}^2$	 Perforated blocks of light concrete Hbl 2 Compression strength $\geq 2 \text{ N/mm}^2$
	 Perforated sand lime bricks KSL12 Compression strength $\geq 12 \text{ N/mm}^2$	 Aerated concrete PP2 Compression strength $\geq 2 \text{ N/mm}^2$
	 Vertically perforated bricks HLz 12 Compression strength $\geq 12 \text{ N/mm}^2$ Bulk density $\geq 1.0 \text{ kg/dm}^3$	

A different and more suitable type of mounting must be chosen by a qualified fitter in all other cases. hülsta cannot accept any responsibility for the choice of any other types of mounting! Please note that if the units are not mounted properly on the wall, there is a risk of the units falling down or tipping over – especially when alternative mounting materials acquired on site have been used. Generally speaking, you as a dealer/qualified fitter are responsible for the correct wall mounting of the units.



Mounting sets

Labelling in type list drawings / assembly notes for wall units

The majority of units have two wall mounting points (= number of support boards), if these are to be fitted as wall units. This is not explicitly mentioned in the type list. If a different number of wall mounting points (= support boards) is required, this is marked in the drawings in the type list with numbers in black boxes. Every support board requires four mounting screws.

- 3** = 3 support boards
- 4** = 4 support boards, etc.

One **assembly mortar set** is sufficient for up to a maximum of 3 support boards or 4 wall side-panels.

Important note: Depending on the composition of the wall (see wall types illustrated above), assembly must be carried out using the special assembly mortar set and a standard trade mastic tool which are the basic essentials for safe and clean workmanship.

Standard set

The standard set consists of 4 plastic Rawl plugs and 4 mounting screws and is sufficient for 1 support board. The standard sets are included in the packet of fittings to match the number of support boards.

Assembly mortar set for up to a maximum of 3 support boards consisting of:

- 9x injection retaining sleeve
- 9x screw-in sleeve
- 1x injection cartridge
- 2x static mixer
- 1x assembly instructions

Please use the mounting screws from the standard set (supplied free of charge).

Example of order:

- Add up number of support boards for all existing unit types
 - Divide the sum by “3”
 - Round up the result to a full number
- = Number of assembly mortar sets required

M2

-

Your Hotline to hülsta

Do you have any questions or require any alterations to your order confirmation?
Do you have any questions on our products or your current order?
Do you have any complaints about supplied goods or required replacement parts?
Contact Telephone: +49 (0) 2563 / 86-1144 • email: orders@huelsta.com

Do you have any questions, suggestions or wishes for the **hülsta Marketing team**
or the **hülsta product seminars**?
Contact Telephone: +49 (0) 2563 / 86-1611 • email: marketing@huelsta.com

hülsta Planning Service

Lots to do? A customer wants his project finished and you haven't got enough time? Or the project is so complex that it will take too much time?

This is exactly the kind of situation we created the hülsta Planning Service for. hülsta's employees create the required project for you at short notice. Based on your information, we implement the project perfectly with all views and a complete order list ready for immediate forwarding to the customer.

The hülsta check list (available at <https://hulsta.com/de/service/showroom/>) makes it all really easy for you. You won't forget anything with this list and the customer receives a project he will be thrilled about as quickly as possible.

hülsta Planning Service

Tel.: +49 (0) 2563 / 86-0

Fax: +49 (0) 2563 / 86-2666

Mail: Planungsservice-Handel@huelsta.de

Workdays from 8.00 a.m. until 6.00 p.m.

Special wishes? Come to us!

Maximum individuality! – Maximal flexibility! – hülsta makes most of your special wishes possible.
And if you do have a wish which is not quite so easy to implement, just give us a call or send us a mail or a fax. We have our own hülsta "Special Wishes Team" who are there to help you realise just these customer requests. These colleagues are professionals when it comes to special products. They plan and calculate the products possible for you and even develop an alternative suggestion if the idea should turn out to be technically impossible.

Here is an overview of the hülsta range of special wishes:

- A lot of special products can be ordered simply via the type list
- Special-sized products are planned simply and professionally
- Competent colleagues advise you by phone, by fax and by mail
- You will be sent alternative suggestions if the idea is technically impossible
- Many special-sized products are available without a surcharge
- Specially qualified carpenters and technicians implement your plans perfectly

hülsta Special Wishes Team

Tel.: +49 (0) 2563 / 86-0

Fax: +49 (0) 2563 / 86-1417

Mail: Sonderwunsch@huelsta.com

We are open Saturdays for you, too!

Our **Saturday hotline** is available all day from **10.00 a.m. until 6.00 p.m.**

Telephone: +49 (0) 2563 / 86-1800

On **working days** the hülsta Sales Department is available all day from **8.00 a.m. until 6.00 p.m.**

hülsta AUNIS

Stand: E 6.2019

Design and concept legally protected, subject to error and alterations to construction, colour and materials by way of technological progress.

hülsta-werke · Karl-Hüls-Straße 1 · D-48703 Stadthoorn
Tel. +49 (0) 2563 / 86-0 · Fax +49 (0) 2563 / 86-1000
www.huelsta.com

hülsta 