

**hülsta** 

Die Möbelmarke.

# Neo

---

**9/19**

**E**

**Type list**

---

[www.huelsta.com](http://www.huelsta.com)

**LIVING**



# NEO

## Contents

	Page
Range introduction, lists of versions, important notes	2-4
Concept and possible arrangements	5
Suggested combinations	6-9
1 - 12 Raster units	10-23
1 - 3 Raster lowboards	24-33
Media accessories for lowboards	34-35
4 and 6 Raster side- and highboards	36-41
4 and 6 Raster side- and highboards with MagicDive	42-43
2 - 3 Raster media lowboards	44-47
Usable size of lowboards, cable management for lowboards	48-49
Media panels, accessories for media panels, column system, flat screen supports	50-52
2 Raster wall units	54-55
Free Raster fitting: planning possibilities	56-57
Carcase units	58-63
Centre partitions, constructional shelves, fitted shelves, open compartments, metal substructures, cover shelves	64-66
Fronts – drawers, flaps, doors	67-74
Rear wall panelling (room dividers)	76-77
Side-panels, accessories for side-panels	78-81
Accessories for (carcase) units	82-84
Dining rooms, coffee tables	85
Lighting, Magic-Tronic, remote control unit	86-87
Sketch raster	89
<b>General information:</b>	
Cable apertures	90
Switch options for lamps	91-93
Special-sized products, special articles	94
Important notes: quality of walls / assembly instruction	95

## Updated living

The clean and simple lines are typical of NEO. The design focuses on handle-less fronts and crisp shapes. It effortlessly matches every lifestyle, personal taste and the respective living environment. A wide choice of dimensions and units makes individual planning particularly easy. NEO has been designed for people who love individuality, comfort and sophisticated functionality. NEO offers different styles, ranging from functional to cosily warm.

### Focussing on the essential:

NEO is unmistakably a hülsta product. The unfussy look perfectly matches minimalist interior design trends, which consistently renounce anything unnecessary.

### Maximum planning flexibility:

NEO offers many different units in various sizes, which can be freestanding, stacked or wall-mounted. Both open compartments and fronts such as doors, flaps and drawers are possible. The range is complemented by a side-panel system and wall panels.

### Wide choice of finishes:

NEO is available in lacquer, high-gloss lacquer in different colours plus wood, thus allowing highly individual designs. Carcases and fronts are available in the same finish or in a mix of materials.

### Functional sophistication:

Design and purpose are closely connected with NEO. Handle-less fronts such as drawers, doors and flaps can be easily opened using Push-to-open-technology, motor-assisted upon request. Special fittings allow units in all sizes to be wall-mounted. Versatile drawer accessories for CDs, cutlery and much more ensure that every inch of the available storage space is usable.

### Integrated media functions:

NEO offers functional yet beautiful solutions for the use of contemporary media. Media panels and media lowboards provide an outstanding media experience.

## Lists of versions

Model no.	Carcase, fronts, wall panels, frames of open compartments	Price group	Model no.	Cover shelves, open compartments (inside), side-panels and shelves, wall shelves, rear walls	Price group
045	White lacquer	I	045	White lacquer	I
046	Grey lacquer	I	046	Grey lacquer	I
<b>NEW</b> 663	Silk grey lacquer	I	<b>NEW</b> 663	Silk grey lacquer	I
051	Natural oak	II	051	Natural oak	II
053	Core walnut	II	053	Core walnut	II
048	High-gloss white lacquer *	II			
049	High-gloss grey lacquer *	II			
<b>NEW</b> 614	High-gloss silk grey lacquer *	II			

\* The inner carcase for high-gloss lacquer versions is in matt lacquer in the matching colour.

## Optional knobs for fronts

All fronts are delivered standard without knobs (hülsta-Push-to-open). It is however possible to fit fronts with knobs (without surcharge; exception: knobs are not possible on all-glass fronts or fronts with glass insets). One knob is fitted on each front of drawers and flaps, two knobs are fitted from a width of 105.6 cm. The hülsta-Push-to-open device is not fitted when optional knobs are included. If drawers are fitted with knobs, these are supplied with **hülsta-SoftFlow** on hidden roller bearings as fully pullout units, with automatic cushioning device. **Please state the required version clearly in the order!**

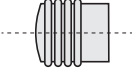
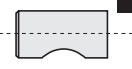
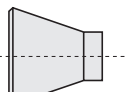
Knob in stainless steel look	Knob in wood/lacquer version, stainless steel look or high-gloss chrome	Knob in wood version or stainless steel look
 <p>Stainless steel look 113</p>	 <p>                     White lacquer 141                      Grey lacquer 145  <b>NEW</b> Silk grey lacquer 150                      Natural oak 146                      Core walnut 147                      Stainless steel look 148                      High-gloss chrome 149                 </p>	 <p>                     Natural oak 156                      Core walnut 157                      Stainless steel look 158                 </p>

## Important notes

### Changing versions:

In NEO colour combinations within individual units are possible. In this case please state the model number clearly and separately in the order! If versions from different price groups are exchanged, the higher price group is always charged.

### Clear glass fronts:

Glass doors and flaps with panels of clear glass on lacquered aluminium frame. **Rear-side rim lacquering** of clear glass doors and flaps optionally in white, grey or silk grey. The aluminium frame is in a standard lacquer colour matching the rear-side rim lacquering of the clear glass doors and flaps. **When ordering units with clear glass doors and flaps please be sure to state the colour of the rear-side rim lacquering!**

### Fitted glass shelves

Fitted glass shelves behind fronts are of clear glass.

### Glass cover shelves:

Glass cover shelves optionally rear-lacquered in white, grey or silk grey. **When ordering rear-lacquered glass cover shelves please be sure to state the desired version!**

### Open glass compartments:

Open glass compartments with sides of clear glass, top and bottom shelf as well as rear wall in wood/lacquer version.

### Standard interior fittings:

Wooden shelves are fitted at intervals of 2 Raster behind wooden doors and glass shelves are fitted behind doors with clear glass fronts and rear-side rim lacquering as well as behind the clear glass panel of doors with clear glass panels.

### Wall units:

If units are planned as wall units, a wall bracket must be ordered.

### Stacked units:

If units are stacked on top of one another, a wall bracket must only be ordered for the stacked unit(s) if the stacked unit is wider than the floor unit or if the units are stacked in an off-set position.

### Fabric-covered flaps:

Fabric-covered flaps optionally in the versions black, white or silver. **Please state clearly in the order!**

### Drawer frames in standard grey

### Combinations of floor and wall units:

If floor and wall units are combined within an arrangement, there must not be any skirting boards in the room near the floor units, otherwise they must be removed.

### Max. load:

Max. load of wooden and glass shelves (up to 70.4 cm width) as well as drawers: 25 kg  
 Max. load of wooden and glass shelves (between 70.4 and 105.6 cm width): 15 kg;  
 from 105.6 cm width: 10 kg  
 Max. load of cover shelves: 35 kg per metre length for floor units.

**Please also note any existing maximum load data for individual units which may be stated later and the important notes on the quality of walls at the end of this type list.**

### hülsta-Push-to-open/hülsta-SoftFlow:

Drawers and flaps with hülsta Push-to-open, also with optional motor support for drawers (not possible in 33.0 cm depth or for lowboards with extra rear wall for cable management). All drawers on hidden bearings as fully pull-out units, with cushioned closing device in combination with motor support. If drawers are fitted with knobs, these are supplied with hülsta-SoftFlow on hidden roller bearings as fully pull-out units with automatic cushioned closing device.

# Range introduction

## Wall fitting

**Important notes:** Generally speaking, you as a dealer/qualified fitter are responsible for the correct wall mounting of the units. That is why wall mounting should only be carried out by properly trained and qualified fitters. hülsta supplies materials for mounting units on walls for nearly all the units and which should be used for safety and for constructional reasons. The assembly materials supplied by hülsta (plugs, screws) are only suitable for fitting components on to concrete in firmness class C12/15. For other materials (please see separate materials table in the wall composition chapter) we provide you with an assembly mortar set as an extra order. Please note that this assembly mortar set is also only suitable for the materials listed in the materials table. If walls are made up of other materials (e.g. plastered or lighter wall materials), one should use another method of mounting better suited to the load on site. Please note that if the units are not mounted properly on the wall, there is a risk of the units falling down or tipping over – especially when alternative mounting materials acquired on site have been used. For the reasons stated above it is absolutely essential to enquire about the composition of any walls before signing any contracts.

## Wall units / stacked units

If 1 and 2 Raster units as well as lowboards are included as wall units, a maximum load per unit of 15 kg per metre must not be exceeded for reasons of stability! Max. load 15 kg per metre:

- 35.2 cm width: 5.0 kg
- 52.8 cm width: 7.5 kg
- 70.4 cm width: 10.0 kg
- 105.6 cm width: 15.0 kg
- 140.8 cm width: 20.0 kg
- 158.4 cm width: 20.0 kg
- 176.0 cm width: 25.0 kg
- 211.2 cm width: 30.0 kg
- 246.4 cm width: 30.0 kg

If 4 - 12 Raster units, side- or highboards are included as wall units, a maximum load per unit of 40 kg must not be exceeded for reasons of stability!

The wall units can only be fitted on absolutely solid walls. Light masonry is not suitable for this purpose.

For each project please remember to leave a 2.0 cm gap at the top to be able to mount units.

If units are planned as wall units, a wall bracket must be ordered.

If units are stacked on top of one another, a wall bracket must only be ordered for the stacked unit(s) if the stacked unit is wider than the floor unit or if the units are stacked in an off-set position.

Low-, side- and highboards with hülsta-MagicDive can not be fitted as wall units.

## Labelling in type list drawings / assembly notes for wall units

### Labelling in type list drawings / assembly notes for wall units

The majority of units have two wall mounting points (= number of base plates), if these are to be fitted as wall units. This is not explicitly mentioned in the type list. If a different number of wall mounting points (= base plates) is required, this is marked in the drawings in the type list with numbers in black boxes. Please be sure to note here the information and notes in the "Wall composition" chapter!

3  
4

## Notes on delivery

### Notes on delivery:

The majority of the units are delivered standard as **fully connected units (glued)** so that the carcass **cannot be disassembled**. There are however some **exceptions** to this rule:

Some carcasses are delivered as complete units but can be **disassembled into individual sections** in the final customer's home. These types are marked with a **1** in the type list.

1

Some carcasses are delivered **in individual sections** because of their size. These types are marked with a **2** in the type list.

2

The fronts with the number **2** are delivered separately and can therefore always be (dis-) assembled.

## Room dividers / rear wall panelling

Low-, side- and highboards in 45.0 and 52.0 cm depth can be used as room dividers.

1 - 6 Raster (carcase) units which are at least 140.8 cm wide, as single units or in a combination of several units, can be used as room dividers in 45.0 and 52.0 cm depth.

The standard rear side of clearly defined room-divider single units is panelled to look like a door if not otherwise stated in the order.

The rear wall panelling is split in the middle in the case of 6 Raster high units from a width of 105.6 cm.

The rear wall panelling is only available in front version.

Units which are fitted with an extra cover shelf can not be used as room dividers.

## Information on the sketches

### Partitions behind flaps/glass flaps

Partitions are used behind flaps/glass flaps in front widths from 105.6 cm. In the sketches the partitions are shown by dotted lines or are shown visibly behind glass flaps.

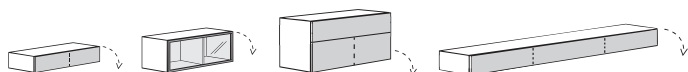

### Split drawer frames

Split drawer frames are used for drawers in front widths from 105.6 cm (the partitions are shown by dotted lines in the sketches). The front widths of the drawers are illustrated at the sketches of the units so that you can order suitable accessories for the drawers.

### Partitions behind doors/glass doors

Partitions are used behind doors/glass doors in front widths from 105.6 cm. In the sketches the partitions are shown by dotted lines or are shown visibly behind glass doors.

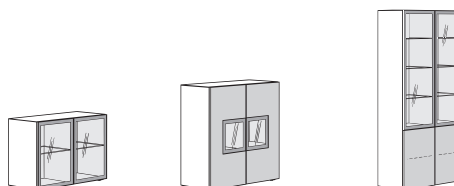

### Order of markings

The markings for the fronts go from left to right and/or from top to bottom.

1 drawer    1 open compartment    1 flap    1 drawer    1 flap

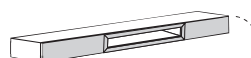



## Combination with units

2x 12 Raster unit with door/glass door

1x 4 Raster sideboard with hülsta-MagicDive in the cover shelf, two drawers each bottom left and right, one fixed panel each at top

1x Metal substructure for 4 Raster sideboard

2x Wall shelf

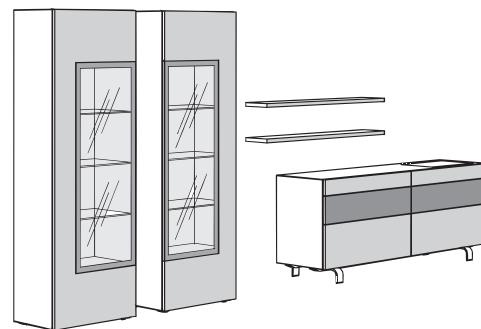

## Combination with units and side-panels

1x 8 Raster unit with door

1x Cover shelf for 8 Raster unit

3x 8 Raster side-panel

1x 6 Raster side-panel

13x Fitted wooden shelf for (wall) side-panels

1x 2 Raster lowboard: floor unit with one drawer left, fabric-covered frame front in black (for loudspeakers) in the centre and one flap right

1x 2 Raster wall unit with flap

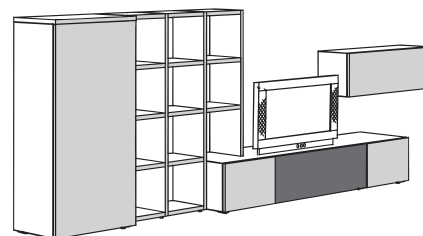

## Combination with units and side-panels

1x Wall shelf with LED lamp

1x 2 Raster wall unit with two flaps, two centre drawers

1x 2 Raster lowboard with two drawers

1x 2 Raster corner shelf incl. vertical panel

1x 2 Raster lowboard with one flap

3x 8 Raster side-panel

1x 6 Raster side-panel

13x Fitted wooden shelf for side-panels

1x 8 Raster unit with door

1x Cover shelf for 8 Raster unit

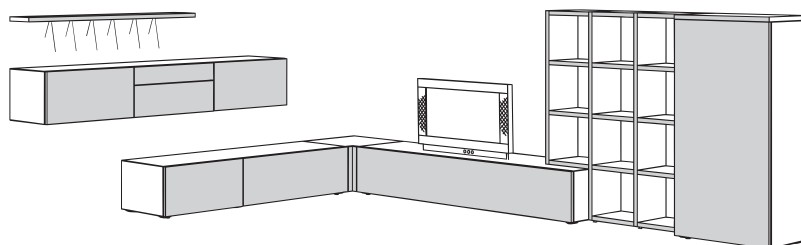

## Combination with units, media panel and wall side-panels

5x 8 Raster wall side-panel

20x Fitted wooden shelf for (wall) side-panels

1x 2 Raster lowboard with four drawers

1x 6 Raster media panel with flat screen support, e.g. THIN 315

1x Media panel shelf

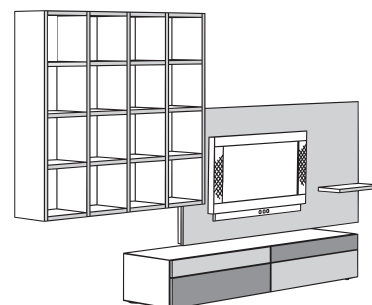

# Suggested combinations

As an alternative to planning an individual unit from the complete range there is the possibility of choosing from specially suggested combinations. This eases planning. Incorporating accessories can enhance the suggested combinations. These are charged extra.

<p>hülsta-MagicDive of glass: with rear-side rim lacquering in carcase version</p> <p>S = Drawer</p>	<p>S = Drawer K = Flap</p>
<p>as illustr. v. versa</p> <p><b>Price gr.</b></p> <p>I - II -</p>	<p><b>980001</b> <b>980101</b></p> <p>- -</p>
<p>S = Drawer</p>	<p>S = Drawer</p>
<p>as illustr. v. versa</p> <p><b>Price gr.</b></p> <p>I - II -</p>	<p><b>980002</b> <b>980102</b></p> <p>- -</p>
<p>S = Drawer K = Flap</p>	<p>S = Drawer K = Flap</p>
<p>as illustr. v. versa</p> <p><b>Price gr.</b></p> <p>I - II -</p>	<p><b>980003</b> <b>980103</b></p> <p>- -</p>
<p>as illustr. v. versa</p> <p><b>Price gr.</b></p> <p>I - II -</p>	<p><b>980004</b> <b>980104</b></p> <p>- -</p>
<p>as illustr. v. versa</p> <p><b>Price gr.</b></p> <p>I - II -</p>	<p><b>980005</b> <b>980105</b></p> <p>- -</p>
<p>as illustr. v. versa</p> <p><b>Price gr.</b></p> <p>I - II -</p>	<p><b>980006</b> <b>980106</b></p> <p>- -</p>

# Suggested combinations

As an alternative to planning an individual unit from the complete range there is the possibility of choosing from specially suggested combinations. This eases planning. Incorporating accessories can enhance the suggested combinations. These are charged extra.

<p>S = Drawer K = Flap</p>	<p>S = Drawer K = Flap SK = Fabric-covered flap</p>
<p>as illustr. v. versa</p> <p><b>Price gr.</b></p> <p>I - II -</p>	<p><b>980009</b> <b>980109</b></p> <p>as illustr. v. versa</p> <p><b>Price gr.</b></p> <p>I - II -</p>
<p>S = Drawer K = Flap</p>	<p>S = Drawer K = Flap</p>
<p>as illustr. v. versa</p> <p><b>Price gr.</b></p> <p>I - II -</p>	<p><b>980011</b> <b>980111</b></p> <p>as illustr. v. versa</p> <p><b>Price gr.</b></p> <p>I - II -</p>
<p>S = Drawer</p>	<p>S = Drawer K = Flap</p>
<p>as illustr. v. versa</p> <p><b>Price gr.</b></p> <p>I - II -</p>	<p><b>980013</b></p> <p>as illustr. v. versa</p> <p><b>Price gr.</b></p> <p>I - II -</p>

# Suggested combinations

As an alternative to planning an individual unit from the complete range there is the possibility of choosing from specially suggested combinations. This eases planning. Incorporating accessories can enhance the suggested combinations. These are charged extra.

<p>S = Drawer K = Flap</p>	<p>S = Drawer K = Flap</p>
<p>as illustr. v. versa</p> <p><b>Price gr.</b></p> <p>I - II -</p>	<p>as illustr. v. versa</p> <p><b>Price gr.</b></p> <p>I - II -</p>
<p>S = Drawer K = Flap</p>	<p>S = Drawer</p>
<p>as illustr. v. versa</p> <p><b>Price gr.</b></p> <p>I - II -</p>	<p>as illustr. v. versa</p> <p><b>Price gr.</b></p> <p>I - II -</p>
<p><b>NEW</b></p> <p>S = Drawer K = Flap</p>	<p><b>NEW</b></p> <p>S = Drawer</p>
<p>as illustr. v. versa</p> <p><b>Price gr.</b></p> <p>I - II -</p>	<p>as illustr. v. versa</p> <p><b>Price gr.</b></p> <p>I - II -</p>

# Suggested combinations

As an alternative to planning an individual unit from the complete range there is the possibility of choosing from specially suggested combinations. This eases planning. Incorporating accessories can enhance the suggested combinations. These are charged extra.

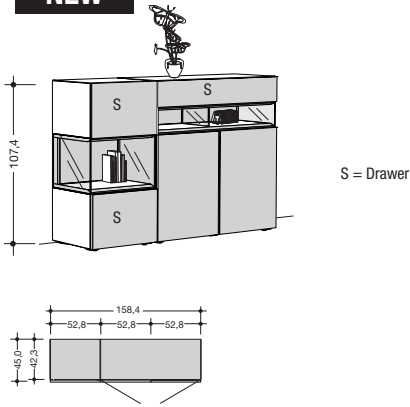
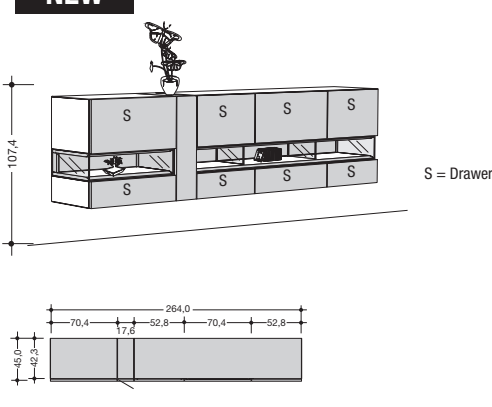
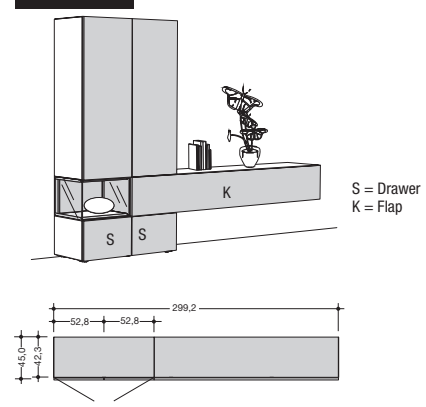
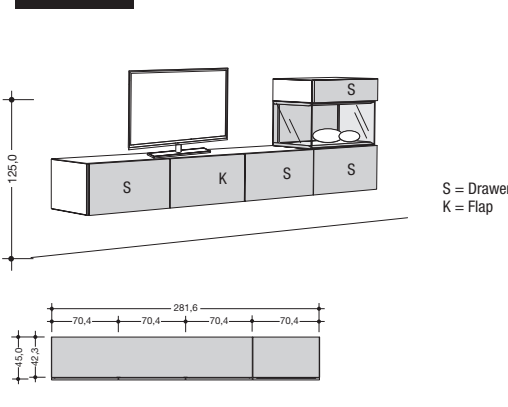
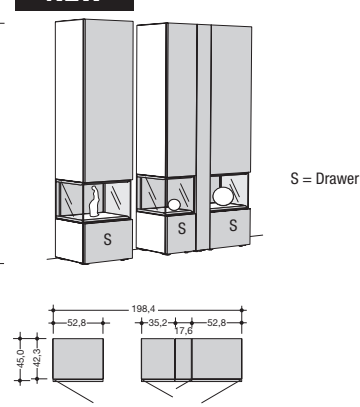
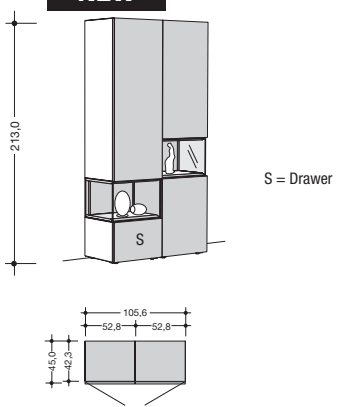
	<p><b>NEW</b></p>  <p>S = Drawer</p>	<p><b>NEW</b></p>  <p>S = Drawer</p>	
<p>as illustr. v. versa</p> <p><b>Price gr.</b></p> <p>I -</p> <p>II -</p>	<p><b>980021</b> <b>980121</b></p>	<p>as illustr. v. versa</p> <p><b>Price gr.</b></p> <p>I -</p> <p>II -</p>	<p><b>980022</b> <b>980122</b></p>
	<p><b>NEW</b></p>  <p>S = Drawer K = Flap</p>	<p><b>NEW</b></p>  <p>S = Drawer K = Flap</p>	
<p>as illustr. v. versa</p> <p><b>Price gr.</b></p> <p>I -</p> <p>II -</p>	<p><b>980023</b> <b>980123</b></p>	<p>as illustr. v. versa</p> <p><b>Price gr.</b></p> <p>I -</p> <p>II -</p>	<p><b>980024</b> <b>980124</b></p>
	<p><b>NEW</b></p>  <p>S = Drawer</p>	<p><b>NEW</b></p>  <p>S = Drawer</p>	
<p>as illustr. v. versa</p> <p><b>Price gr.</b></p> <p>I -</p> <p>II -</p>	<p><b>980025</b> <b>980125</b></p>	<p>as illustr. v. versa</p> <p><b>Price gr.</b></p> <p>I -</p> <p>II -</p>	<p><b>980026</b> <b>980126</b></p>



# 1 Raster units

Accessories: see pages 82-84.  
Lamps: see pages 86-87.

<b>1 Raster units</b> 17.6 cm high (19.4 cm high incl. 1.8 cm high plinth adjusters), <b>33.0 or 45.0 cm deep</b>	1 drawer		1 drawer		1 drawer		1 drawer		
	35.2 cm wide		52.8 cm wide		70.4 cm wide		105.6 cm wide		
	Price gr.	33.0 cm deep	45.0 cm deep	33.0 cm deep	45.0 cm deep	33.0 cm deep	45.0 cm deep	33.0 cm deep	45.0 cm deep
		<b>13831</b>	<b>1381</b>	<b>15831</b>	<b>1581</b>	<b>17831</b>	<b>1781</b>	<b>110831</b>	<b>11081</b>
	-	-	-	-	-	-	-	-	
	-	-	-	-	-	-	-	-	
	1 flap		1 flap		1 flap		1 flap		
	35.2 cm wide		52.8 cm wide		70.4 cm wide		105.6 cm wide		
Price gr.	Flap hinge at bottom		Flap hinge at bottom		Flap hinge at bottom		Flap hinge at bottom		
	33.0 cm deep	45.0 cm deep	33.0 cm deep	45.0 cm deep	33.0 cm deep	45.0 cm deep	33.0 cm deep	45.0 cm deep	
	<b>13838</b>	<b>1388</b>	<b>15838</b>	<b>1588</b>	<b>17838</b>	<b>1788</b>	<b>110838</b>	<b>11088</b>	
	-	-	-	-	-	-	-	-	
	-	-	-	-	-	-	-	-	

When used as wall units or stacked units:  
 Max. load 15 kg per metre:  
 35.2 cm width: 5.0 kg  
 52.8 cm width: 7.5 kg  
 70.4 cm width: 10.0 kg  
 105.6 cm width: 15.0 kg

## Wall bracket

If units are to be included as wall units, a wall bracket must be ordered. If units are stacked on top of one another, a wall bracket must only be ordered for the stacked unit(s) if the stacked unit is wider than the floor unit or if the units are stacked in an off-set position.	for 35.2 cm width	for 52.8 cm width	for 70.4 cm width	for 105.6 cm width
	<b>4352</b>	<b>4528</b>	<b>4704</b>	<b>4105</b>
	-	-	-	-

## NEW 1 Raster open glass compartments









<b>1 Raster open glass compartments</b> 17.6 cm high <b>33.0 or 45.0 cm deep</b>  Further units resp. a cover shelf must be planned above and below the open glass compartments.  Please state the required version clearly in the order!					with 1 glass partition		with 1 glass partition		with 1 glass partition				
	35.2 cm wide		52.8 cm wide		70.4 cm wide		105.6 cm wide		105.6 cm wide		140.8 cm wide		
	Price gr.	33.0 cm deep	45.0 cm deep	33.0 cm deep	45.0 cm deep	33.0 cm deep	45.0 cm deep	33.0 cm deep	45.0 cm deep	33.0 cm deep	45.0 cm deep	33.0 cm deep	45.0 cm deep
		<b>1395</b>	<b>1394</b>	<b>1595</b>	<b>1594</b>	<b>1795</b>	<b>1794</b>	<b>11095</b>	<b>11094</b>	<b>110951</b> <b>110952</b>	<b>110941</b> <b>110942</b>	<b>11495</b>	<b>11494</b>
	-	-	-	-	-	-	-	-	-	-	-	-	
	-	-	-	-	-	-	-	-	-	-	-	-	
	with 2 glass partitions		with 2 glass partitions		with 2 glass partitions		with 2 glass partitions		with 3 glass partitions		with 2 glass partitions		
	140.8 cm wide		158.4 cm wide		176.0 cm wide		176.0 cm wide		211.2 cm wide		211.2 cm wide		
Price gr.	33.0 cm deep	45.0 cm deep	33.0 cm deep	45.0 cm deep	33.0 cm deep	45.0 cm deep	33.0 cm deep	45.0 cm deep	33.0 cm deep	45.0 cm deep	33.0 cm deep	45.0 cm deep	
	<b>114951</b> <b>114952</b>	<b>114941</b> <b>114942</b>	<b>11595</b>	<b>11594</b>	<b>11795</b>	<b>11794</b>	<b>117951</b> <b>117952</b>	<b>117941</b> <b>117942</b>	<b>12195</b>	<b>12194</b>	<b>121951</b>	<b>121941</b>	
	-	-	-	-	-	-	-	-	-	-	-	-	
	-	-	-	-	-	-	-	-	-	-	-	-	

**Assembly notes for wall units:**  
Please be sure to note here the information and notes in the "Wall composition" chapter!

**3**  
**4**

## 2 Raster units

**NEO**

<b>2 Raster units</b> 35.2 cm high (37.0 cm high incl. 1.8 cm high plinth adjusters), <b>33.0 or 45.0 cm deep</b>	1 drawer		1 drawer		1 drawer		1 drawer		
									
	35.2 cm wide		52.8 cm wide		70.4 cm wide		(cannot be used as a wall unit)		
	33.0 cm deep		45.0 cm deep		33.0 cm deep		45.0 cm deep		
<b>Price gr.</b>	<b>I</b>	<b>23831</b>	<b>2381</b>	<b>25831</b>	<b>2581</b>	<b>27831</b>	<b>2781</b>	<b>210831</b>	<b>21081</b>
	<b>II</b>	-	-	-	-	-	-	-	-
When used as wall units or stacked units: Max. load 15 kg per metre: 35.2 cm width: 5.0 kg 52.8 cm width: 7.5 kg 70.4 cm width: 10.0 kg 105.6 cm width: 15.0 kg	2 drawers		2 drawers		2 drawers		2 drawers		
									
	35.2 cm wide		52.8 cm wide		70.4 cm wide		(cannot be used as a wall unit)		
	33.0 cm deep		45.0 cm deep		33.0 cm deep		45.0 cm deep		
<b>Price gr.</b>	<b>I</b>	<b>23931</b>	<b>2391</b>	<b>25931</b>	<b>2591</b>	<b>27931</b>	<b>2791</b>	<b>210931</b>	<b>21091</b>
	<b>II</b>	-	-	-	-	-	-	-	-

## Wall bracket





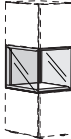
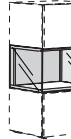
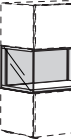
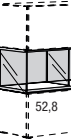
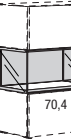
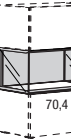
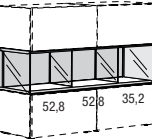
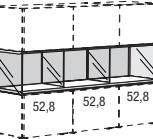
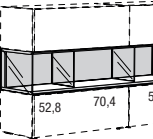
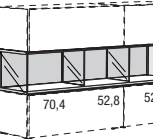
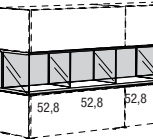
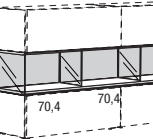









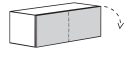

If units are to be included as wall units, a wall bracket must be ordered. If units are stacked on top of one another, a wall bracket must only be ordered for the stacked unit(s) if the stacked unit is wider than the floor unit or if the units are stacked in an off-set position.	for 35.2 cm width	for 52.8 cm width	for 70.4 cm width	for 105.6 cm width
	<b>4352</b>	<b>4528</b>	<b>4704</b>	<b>4105</b>
	-	-	-	-

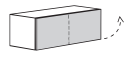
## **NEW** 2 Raster open glass compartments

<b>2 Raster open glass compartments</b> 35.2 cm high <b>33.0 or 45.0 cm deep</b>					with 1 glass partition		with 1 glass partition		with 1 glass partition				
													
	35.2 cm wide		52.8 cm wide		70.4 cm wide		105.6 cm wide		105.6 cm wide		140.8 cm wide		
	33.0 cm deep		45.0 cm deep		33.0 cm deep		45.0 cm deep		33.0 cm deep		45.0 cm deep		
<b>Price gr.</b>	<b>I</b>	<b>2395</b>	<b>2394</b>	<b>2595</b>	<b>2594</b>	<b>2795</b>	<b>2794</b>	<b>21095</b>	<b>21094</b>	<b>210951</b> <b>210952</b>	<b>210941</b> <b>210942</b>	<b>21495</b>	<b>21494</b>
	<b>II</b>	-	-	-	-	-	-	-	-	-	-	-	-
Further units resp. a cover shelf must be planned above and below the open glass compartments.  Please state the required version clearly in the order!	with 2 glass partitions		with 2 glass partitions		with 2 glass partitions		with 2 glass partitions		with 3 glass partitions		with 2 glass partitions		
													
	140.8 cm wide		158.4 cm wide		176.0 cm wide		176.0 cm wide		211.2 cm wide		211.2 cm wide		
	33.0 cm deep		45.0 cm deep		33.0 cm deep		45.0 cm deep		33.0 cm deep		45.0 cm deep		
<b>Price gr.</b>	<b>I</b>	<b>214951</b> <b>214952</b>	<b>214941</b> <b>214942</b>	<b>21595</b>	<b>21594</b>	<b>21795</b>	<b>21794</b>	<b>217951</b> <b>217952</b>	<b>217941</b> <b>217942</b>	<b>22195</b>	<b>22194</b>	<b>221951</b>	<b>221941</b>
	<b>II</b>	-	-	-	-	-	-	-	-	-	-	-	-

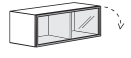
Accessories: see pages 82-84.  
Lamps: see pages 86-87.

## 2 Raster units

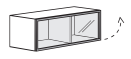
<p><b>2 Raster units</b> 35.2 cm high (37.0 cm high incl. 1.8 cm high plinth adjusters), <b>33.0 or 45.0 cm deep</b></p>  <p>1 door</p> <p>17.6 cm wide</p>										
	<b>Price gr.</b> I II	33.0 cm deep	45.0 cm deep							
		213311 L 213312 R	21311 L 21312 R							
			1 flap		1 flap		1 flap		1 flap	
										
			35.2 cm wide		52.8 cm wide		70.4 cm wide		105.6 cm wide	
	<b>Price gr.</b> I II	Flap hinge at bottom		Flap hinge at bottom		Flap hinge at bottom		Flap hinge at bottom		
			33.0 cm deep	45.0 cm deep	33.0 cm deep	45.0 cm deep	33.0 cm deep	45.0 cm deep	33.0 cm deep	45.0 cm deep
			23838	2388	25838	2588	27838	2788	210838	21088
			-	-	-	-	-	-	-	-
			1 flap		1 flap		1 flap		1 flap	
										
			35.2 cm wide		52.8 cm wide		70.4 cm wide		105.6 cm wide	
	<b>Price gr.</b> I II	Flap hinge at top		Flap hinge at top		Flap hinge at top		Flap hinge at top		
			33.0 cm deep	45.0 cm deep	33.0 cm deep	45.0 cm deep	33.0 cm deep	45.0 cm deep	33.0 cm deep	45.0 cm deep
			23839	2389	25839	2589	27839	2789	210839	21089
			-	-	-	-	-	-	-	-
			1 glass flap		1 glass flap		1 glass flap		1 glass flap	
										
			35.2 cm wide		52.8 cm wide		70.4 cm wide		105.6 cm wide	
	<b>Price gr.</b> I II	Flap hinge at bottom		Flap hinge at bottom		Flap hinge at bottom		Flap hinge at bottom		
			33.0 cm deep	45.0 cm deep	33.0 cm deep	45.0 cm deep	33.0 cm deep	45.0 cm deep	33.0 cm deep	45.0 cm deep
			23834	2384	25834	2584	27834	2784	210834	21084
			-	-	-	-	-	-	-	-
		1 glass flap		1 glass flap		1 glass flap		1 glass flap		
										
		35.2 cm wide		52.8 cm wide		70.4 cm wide		105.6 cm wide		
<b>Price gr.</b> I II	Flap hinge at top		Flap hinge at top		Flap hinge at top		Flap hinge at top			
		33.0 cm deep	45.0 cm deep	33.0 cm deep	45.0 cm deep	33.0 cm deep	45.0 cm deep	33.0 cm deep	45.0 cm deep	
		23835	2385	25835	2585	27835	2785	210835	21085	
		-	-	-	-	-	-	-	-	

When used as wall units or stacked units:  
Max. load 15 kg per metre:  
35.2 cm width: 5.0 kg  
52.8 cm width: 7.5 kg  
70.4 cm width: 10.0 kg  
105.6 cm width: 15.0 kg

## Wall bracket













<p>If units are to be included as wall units, a wall bracket must be ordered. If units are stacked on top of one another, a wall bracket must only be ordered for the stacked unit(s) if the stacked unit is wider than the floor unit or if the units are stacked in an off-set position.</p>	for 17.6 cm width	for 35.2 cm width	for 52.8 cm width	for 70.4 cm width	for 105.6 cm width
	4170	4352	4528	4704	4105
	-	-	-	-	-

L/R = Door hinge left/right

E 5.2018

Wohnen: NEO

### 3 Raster units

<p><b>3 Raster units</b> 52.8 cm high (54.6 cm high incl. 1.8 cm high plinth adjusters), <b>33.0 or 45.0 cm deep</b></p>  <p>17.6 cm wide</p>	1 door									
	<b>Price gr.</b>	33.0 cm deep	45.0 cm deep							
		<b>313311 L</b> <b>313312 R</b>	<b>31311 L</b> <b>31312 R</b>							
	I	-	-							
	II	-	-							
			1 drawer; 1 flap		1 drawer; 1 flap		1 drawer; 1 flap		1 drawer; 1 flap	
										
			35.2 cm wide		52.8 cm wide		70.4 cm wide		105.6 cm wide	
	<b>Price gr.</b>	Flap hinge at bottom		Flap hinge at bottom		Flap hinge at bottom		Flap hinge at bottom		
		33.0 cm deep	45.0 cm deep	33.0 cm deep	45.0 cm deep	33.0 cm deep	45.0 cm deep	33.0 cm deep	45.0 cm deep	
<b>33831</b>		<b>3381</b>	<b>35831</b>	<b>3581</b>	<b>37831</b>	<b>3781</b>	<b>310831</b>	<b>31081</b>		
I	-	-	-	-	-	-	-	-		
II	-	-	-	-	-	-	-	-		
		2 drawers		2 drawers		2 drawers		2 drawers		
										
		35.2 cm wide		52.8 cm wide		70.4 cm wide		105.6 cm wide		
<b>Price gr.</b>	33.0 cm deep	45.0 cm deep	33.0 cm deep	45.0 cm deep	33.0 cm deep	45.0 cm deep	33.0 cm deep	45.0 cm deep		
	<b>33931</b>	<b>3391</b>	<b>35931</b>	<b>3591</b>	<b>37931</b>	<b>3791</b>	<b>310931</b>	<b>31091</b>		
	-	-	-	-	-	-	-	-		
I	-	-	-	-	-	-	-	-		
II	-	-	-	-	-	-	-	-		
		1 flap; 1 drawer		1 flap; 1 drawer		1 flap; 1 drawer		1 flap; 1 drawer		
										
		35.2 cm wide		52.8 cm wide		70.4 cm wide		105.6 cm wide		
<b>Price gr.</b>	Flap hinge at bottom		Flap hinge at bottom		Flap hinge at bottom		Flap hinge at bottom			
	33.0 cm deep	45.0 cm deep	33.0 cm deep	45.0 cm deep	33.0 cm deep	45.0 cm deep	33.0 cm deep	45.0 cm deep		
	<b>33631</b>	<b>3361</b>	<b>35631</b>	<b>3561</b>	<b>37631</b>	<b>3761</b>	<b>310631</b>	<b>31061</b>		
I	-	-	-	-	-	-	-	-		
II	-	-	-	-	-	-	-	-		

















When used as wall units or stacked units:  
Max. load 15 kg per metre:  
35.2 cm width: 5.0 kg  
52.8 cm width: 7.5 kg  
70.4 cm width: 10.0 kg  
105.6 cm width: 15.0 kg

### Wall bracket

<p>If units are to be included as wall units, a wall bracket must be ordered. If units are stacked on top of one another, a wall bracket must only be ordered for the stacked unit(s) if the stacked unit is wider than the floor unit or if the units are stacked in an off-set position.</p>	for 17.6 cm width	for 35.2 cm width	for 52.8 cm width	for 70.4 cm width	for 105.6 cm width
	<b>4170</b>	<b>4352</b>	<b>4528</b>	<b>4704</b>	<b>4105</b>
	-	-	-	-	-

# 4 Raster units

Accessories: see pages 82-84.  
Lamps: see pages 86-87.

<p><b>4 Raster units</b> 70.4 cm high (72.2 cm high incl. 1.8 cm high plinth adjusters), <b>33.0 or 45.0 cm deep</b></p>	1 door		1 door		1 door		1 door		2 doors		
											
	17.6 cm wide		35.2 cm wide		52.8 cm wide		70.4 cm wide		105.6 cm wide		
	Price gr.	33.0 cm deep	45.0 cm deep	33.0 cm deep	45.0 cm deep	33.0 cm deep	45.0 cm deep	33.0 cm deep	45.0 cm deep	33.0 cm deep	45.0 cm deep
		<b>413311 L</b> <b>413312 R</b>	<b>41311 L</b> <b>41312 R</b>	<b>433311 L</b> <b>433311 R</b>	<b>43311 L</b> <b>43312 R</b>	<b>453311 L</b> <b>453312 R</b>	<b>45311 L</b> <b>45312 R</b>	<b>473311 L</b> <b>473312 R</b>	<b>47311 L</b> <b>47312 R</b>	<b>410331</b>	<b>41031</b>
	I	-	-	-	-	-	-	-	-	-	-
	II	-	-	-	-	-	-	-	-	-	-
			2 drawers		2 drawers		2 drawers		2 drawers		
											
			35.2 cm wide		52.8 cm wide		70.4 cm wide		105.6 cm wide		
Price gr.			33.0 cm deep	45.0 cm deep	33.0 cm deep	45.0 cm deep	33.0 cm deep	45.0 cm deep	33.0 cm deep	45.0 cm deep	
			<b>43831</b>	<b>4381</b>	<b>45831</b>	<b>4581</b>	<b>47831</b>	<b>4781</b>	<b>410831</b>	<b>41081</b>	
I			-	-	-	-	-	-	-	-	
II			-	-	-	-	-	-	-	-	
		3 drawers		3 drawers		3 drawers		3 drawers			
											
		35.2 cm wide		52.8 cm wide		70.4 cm wide		105.6 cm wide			
Price gr.			33.0 cm deep	45.0 cm deep	33.0 cm deep	45.0 cm deep	33.0 cm deep	45.0 cm deep	33.0 cm deep	45.0 cm deep	
			<b>43931</b>	<b>4391</b>	<b>45931</b>	<b>4591</b>	<b>47931</b>	<b>4791</b>	<b>410931</b>	<b>41091</b>	
I			-	-	-	-	-	-	-	-	
II			-	-	-	-	-	-	-	-	
		1 glass door		1 glass door		1 glass door		2 glass doors			
											
		35.2 cm wide		52.8 cm wide		70.4 cm wide		105.6 cm wide			
Price gr.			33.0 cm deep	45.0 cm deep	33.0 cm deep	45.0 cm deep	33.0 cm deep	45.0 cm deep	33.0 cm deep	45.0 cm deep	
			<b>434311 L</b> <b>434312 R</b>	<b>43411 L</b> <b>43412 R</b>	<b>454311 L</b> <b>454312 R</b>	<b>45411 L</b> <b>45412 R</b>	<b>474311 L</b> <b>474312 R</b>	<b>47411 L</b> <b>47412 R</b>	<b>410431</b>	<b>41041</b>	
I			-	-	-	-	-	-	-	-	
II			-	-	-	-	-	-	-	-	

When used as wall units or stacked units:  
Max. load per unit: 40 kg

## Wall bracket

<p>If units are to be included as wall units, a wall bracket must be ordered. If units are stacked on top of one another, a wall bracket must only be ordered for the stacked unit(s) if the stacked unit is wider than the floor unit or if the units are stacked in an off-set position.</p>	for 17.6 cm width	for 35.2 cm width	for 52.8 cm width	for 70.4 cm width	for 105.6 cm width
	<b>4170</b>	<b>4352</b>	<b>4528</b>	<b>4704</b>	<b>4105</b>
	-	-	-	-	-

L/R = Door hinge left/right

E 5.2018

Wohnen: NEO













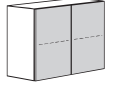

Assembly notes for wall units:  
Please be sure to note here the information  
and notes in the "Wall composition" chapter!

3  
4

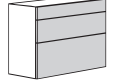
**NEW** 5 Raster units

**NEO**

<p><b>5 Raster units</b> 88.0 cm high (89.8 cm high incl. 1.8 cm high plinth adjusters), <b>33.0 or 45.0 cm deep</b></p>	1 door		1 door		1 door		1 door		2 doors			
												
	17.6 cm wide		35.2 cm wide		52.8 cm wide		70.4 cm wide		105.6 cm wide			
	Price gr.	33.0 cm deep	45.0 cm deep	33.0 cm deep	45.0 cm deep	33.0 cm deep	45.0 cm deep	33.0 cm deep	45.0 cm deep	33.0 cm deep	45.0 cm deep	
		513311 L 513312 R	51311 L 51312 R	533311 L 533312 R	53311 L 53312 R	553311 L 553312 R	55311 L 55312 R	573311 L 573312 R	57311 L 57312 R	510331	51031	
	I	-	-	-	-	-	-	-	-	-	-	
	II	-	-	-	-	-	-	-	-	-	-	
	3 drawers			3 drawers			3 drawers			3 drawers		
												
	35.2 cm wide			52.8 cm wide			70.4 cm wide			105.6 cm wide		
Price gr.	33.0 cm deep		45.0 cm deep		33.0 cm deep		45.0 cm deep		33.0 cm deep		45.0 cm deep	
	53931		5391		55931		5591		57931		5791	
I	-		-		-		-		-		-	
II	-		-		-		-		-		-	
1 glass door			1 glass door			1 glass door			2 glass doors			
												
35.2 cm wide			52.8 cm wide			70.4 cm wide			105.6 cm wide			
Price gr.	33.0 cm deep		45.0 cm deep		33.0 cm deep		45.0 cm deep		33.0 cm deep		45.0 cm deep	
	534311 L 534312 R		53411 L 53412 R		554311 L 554312 R		55411 L 55412 R		574311 L 574312 R		57411 L 57412 R	
I	-		-		-		-		-		-	
II	-		-		-		-		-		-	
When used as wall units or stacked units: Max. load per unit: 40 kg												

**Wall bracket**

<p>If units are to be included as wall units, a wall bracket must be ordered. If units are stacked on top of one another, a wall bracket must only be ordered for the stacked unit(s) if the stacked unit is wider than the floor unit or if the units are stacked in an off-set position.</p>	for 17.6 cm width	for 35.2 cm width	for 52.8 cm width	for 70.4 cm width	for 105.6 cm width
	4170	4352	4528	4704	4105
	-	-	-	-	-

# 6 Raster units

Accessories: see pages 82-84.  
Lamps: see pages 86-87.







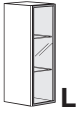

<b>6 Raster units</b> 105.6 cm high (107.4 cm high incl. 1.8 cm high plinth adjusters), 33.0 or 45.0 cm deep	1 door		1 door		1 door		1 door		2 doors		
	17.6 cm wide		35.2 cm wide		52.8 cm wide		70.4 cm wide		105.6 cm wide		
	Price gr.	33.0 cm deep	45.0 cm deep	33.0 cm deep	45.0 cm deep	33.0 cm deep	45.0 cm deep	33.0 cm deep	45.0 cm deep	33.0 cm deep	45.0 cm deep
		<b>613311 L</b> <b>613312 R</b>	<b>61311 L</b> <b>61312 R</b>	<b>632311 L</b> <b>632312 R</b>	<b>63211 L</b> <b>63212 R</b>	<b>652311 L</b> <b>652312 R</b>	<b>65211 L</b> <b>65212 R</b>	<b>672311 L</b> <b>672312 R</b>	<b>67211 L</b> <b>67212 R</b>	<b>610231</b>	<b>61021</b>
	I	-	-	-	-	-	-	-	-	-	-
	II	-	-	-	-	-	-	-	-	-	-
	2 drawers; 1 door			2 drawers; 1 door			2 drawers; 1 door			2 drawers; 2 doors	
	35.2 cm wide			52.8 cm wide			70.4 cm wide			105.6 cm wide	
Price gr.			33.0 cm deep	45.0 cm deep	33.0 cm deep	45.0 cm deep	33.0 cm deep	45.0 cm deep	33.0 cm deep	45.0 cm deep	
			<b>634311 L</b> <b>634312 R</b>	<b>63411 L</b> <b>63412 R</b>	<b>654311 L</b> <b>654312 R</b>	<b>65411 L</b> <b>65412 R</b>	<b>674311 L</b> <b>674312 R</b>	<b>67411 L</b> <b>67412 R</b>	<b>610431</b>	<b>61041</b>	
I			-	-	-	-	-	-	-	-	
II			-	-	-	-	-	-	-	-	
3 drawers			3 drawers			3 drawers			3 drawers		
35.2 cm wide			52.8 cm wide			70.4 cm wide			105.6 cm wide		
Price gr.			33.0 cm deep	45.0 cm deep	33.0 cm deep	45.0 cm deep	33.0 cm deep	45.0 cm deep	33.0 cm deep	45.0 cm deep	
			<b>63631</b>	<b>6361</b>	<b>65631</b>	<b>6561</b>	<b>67631</b>	<b>6761</b>	<b>610631</b>	<b>61061</b>	
I			-	-	-	-	-	-	-	-	
II			-	-	-	-	-	-	-	-	
4 drawers			4 drawers			4 drawers			4 drawers		
35.2 cm wide			52.8 cm wide			70.4 cm wide			105.6 cm wide		
Price gr.			33.0 cm deep	45.0 cm deep	33.0 cm deep	45.0 cm deep	33.0 cm deep	45.0 cm deep	33.0 cm deep	45.0 cm deep	
			<b>63731</b>	<b>6371</b>	<b>65731</b>	<b>6571</b>	<b>67731</b>	<b>6771</b>	<b>610731</b>	<b>61071</b>	
I			-	-	-	-	-	-	-	-	
II			-	-	-	-	-	-	-	-	

When used as wall units or stacked units:  
Max. load per unit: 40 kg

## Wall bracket

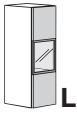
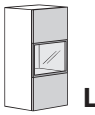
If units are to be included as wall units, a wall bracket must be ordered. If units are stacked on top of one another, a wall bracket must only be ordered for the stacked unit(s) if the stacked unit is wider than the floor unit or if the units are stacked in an off-set position.	for 17.6 cm width	for 35.2 cm width	for 52.8 cm width	for 70.4 cm width	for 105.6 cm width
	<b>4170</b>	<b>4352</b>	<b>4528</b>	<b>4704</b>	<b>4105</b>
	-	-	-	-	-

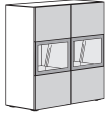
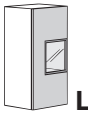
## 6 Raster units

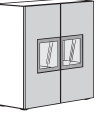
<p><b>6 Raster units</b> 105.6 cm high (107.4 cm high incl. 1.8 cm high plinth adjusters), <b>33.0 or 45.0 cm deep</b></p>	1 glass door		1 glass door		1 glass door		2 glass doors		
									
	35.2 cm wide		52.8 cm wide		70.4 cm wide		105.6 cm wide		
	<b>Price gr.</b>	33.0 cm deep	45.0 cm deep	33.0 cm deep	45.0 cm deep	33.0 cm deep	45.0 cm deep	33.0 cm deep	45.0 cm deep
		<b>635341 L</b> <b>635342 R</b>	<b>63541 L</b> <b>63542 R</b>	<b>655341 L</b> <b>655342 R</b>	<b>65541 L</b> <b>65542 R</b>	<b>675341 L</b> <b>675342 R</b>	<b>67541 L</b> <b>67542 R</b>	<b>610534</b>	<b>61054</b>
	I	-	-	-	-	-	-	-	-
	II	-	-	-	-	-	-	-	-
	1 door/glass door		1 door/glass door		1 door/glass door		2 doors/glass doors		
									
	35.2 cm wide		52.8 cm wide		70.4 cm wide		105.6 cm wide		
<b>Price gr.</b>	33.0 cm deep	45.0 cm deep	33.0 cm deep	45.0 cm deep	33.0 cm deep	45.0 cm deep	33.0 cm deep	45.0 cm deep	
	<b>633341 L</b> <b>633342 R</b>	<b>63341 L</b> <b>63342 R</b>	<b>653341 L</b> <b>653342 R</b>	<b>65341 L</b> <b>65342 R</b>	<b>673341 L</b> <b>673342 R</b>	<b>67341 L</b> <b>67342 R</b>	<b>610334</b>	<b>61034</b>	
I	-	-	-	-	-	-	-	-	
II	-	-	-	-	-	-	-	-	
			1 door/glass door		1 door/glass door		2 doors/glass doors		
									
			52.8 cm wide		70.4 cm wide		105.6 cm wide		
as illustr. (L) v. versa (R)			33.0 cm deep	45.0 cm deep	33.0 cm deep	45.0 cm deep	33.0 cm deep	45.0 cm deep	
			<b>654341 L</b> <b>654342 R</b>	<b>65441 L</b> <b>65442 R</b>	<b>674341 L</b> <b>674342 R</b>	<b>67441 L</b> <b>67442 R</b>	<b>610434</b>	<b>61044</b>	
I			-	-	-	-	-	-	
II			-	-	-	-	-	-	
When used as wall units or stacked units: Max. load per unit: 40 kg									

## Wall bracket

<p>If units are to be included as wall units, a wall bracket must be ordered. If units are stacked on top of one another, a wall bracket must only be ordered for the stacked unit(s) if the stacked unit is wider than the floor unit or if the units are stacked in an off-set position.</p>	for 35.2 cm width	for 52.8 cm width	for 70.4 cm width	for 105.6 cm width
	<b>4352</b>	<b>4528</b>	<b>4704</b>	<b>4105</b>
	-	-	-	-

# 8 Raster units

Accessories: see pages 82-84.  
Lamps: see pages 86-87.

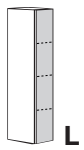
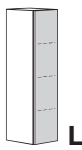
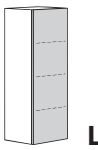
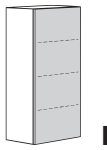
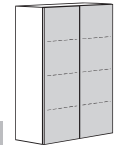
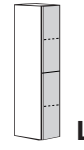
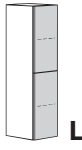
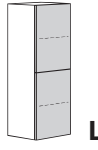
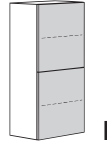
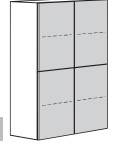
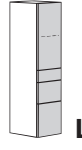
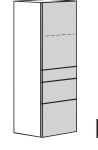
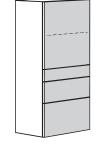
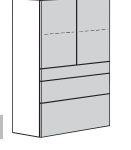
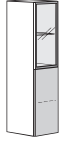
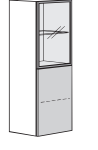
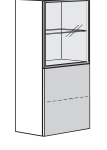
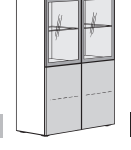
<b>8 Raster units</b> 140.8 cm high (142.6 cm high incl. 1.8 cm high plinth adjusters), 33.0 or 45.0 cm deep	1 door		1 door		1 door		1 door		2 doors			
												
	17.6 cm wide		35.2 cm wide		52.8 cm wide		70.4 cm wide		105.6 cm wide			
	Price gr.	33.0 cm deep	45.0 cm deep	33.0 cm deep	45.0 cm deep	33.0 cm deep	45.0 cm deep	33.0 cm deep	45.0 cm deep	33.0 cm deep	45.0 cm deep	
		813311 L 813312 R	81311 L 81312 R	832311 L 832311 R	83211 L 83212 R	852311 L 852312 R	85211 L 85212 R	872311 L 872312 R	87211 L 87212 R	810231	81021	
	I	-	-	-	-	-	-	-	-	-	-	
	II	-	-	-	-	-	-	-	-	-	-	
	2 doors		2 doors		2 doors		2 doors		4 doors			
												
	17.6 cm wide		35.2 cm wide		52.8 cm wide		70.4 cm wide		105.6 cm wide			
Price gr.	33.0 cm deep	45.0 cm deep	33.0 cm deep	45.0 cm deep	33.0 cm deep	45.0 cm deep	33.0 cm deep	45.0 cm deep	33.0 cm deep	45.0 cm deep		
	814311 L 814312 R	81411 L 81412 R	833311 L 833312 R	83311 L 83312 R	853311 L 853312 R	85311 L 85312 R	873311 L 873312 R	87311 L 87312 R	810331	81031		
I	-	-	-	-	-	-	-	-	-	-		
II	-	-	-	-	-	-	-	-	-	-		
1 door; 3 drawers			1 door; 3 drawers			1 door; 3 drawers			2 doors; 3 drawers			
												
35.2 cm wide			52.8 cm wide			70.4 cm wide			105.6 cm wide			
Price gr.	33.0 cm deep		45.0 cm deep		33.0 cm deep		45.0 cm deep		33.0 cm deep		45.0 cm deep	
	834311 L 834312 R		83411 L 83412 R		854311 L 854312 R		85411 L 85412 R		874311 L 874312 R		87411 L 87412 R	
I	-		-		-		-		-		-	
II	-		-		-		-		-		-	
1 glass door; 1 door			1 glass door; 1 door			1 glass door; 1 door			2 glass doors; 2 doors			
												
35.2 cm wide			52.8 cm wide			70.4 cm wide			105.6 cm wide			
Price gr.	33.0 cm deep		45.0 cm deep		33.0 cm deep		45.0 cm deep		33.0 cm deep		45.0 cm deep	
	831341 L 831342 R		83141 L 83142 R		851341 L 851342 R		85141 L 85142 R		871341 L 871342 R		87141 L 87142 R	
I	-		-		-		-		-		-	
II	-		-		-		-		-		-	

When used as wall units or stacked units:  
Max. load per unit: 40 kg

## Wall bracket

If units are to be included as wall units, a wall bracket must be ordered. If units are stacked on top of one another, a wall bracket must only be ordered for the stacked unit(s) if the stacked unit is wider than the floor unit or if the units are stacked in an off-set position.	for 17.6 cm width	for 35.2 cm width	for 52.8 cm width	for 70.4 cm width	for 105.6 cm width
	4170	4352	4528	4704	4105
	-	-	-	-	-

**Notes on delivery:**  
Please see here the information on range introduction pages.

**Assembly notes for wall units:**  
Please be sure to note here the information and notes in the "Wall composition" chapter!

**NEO**

# 8 Raster units

<p><b>8 Raster units</b> 140.8 cm high (142.6 cm high incl. 1.8 cm high plinth adjusters), <b>33.0 or 45.0 cm deep</b></p>	1 glass door; 3 drawers		1 glass door; 3 drawers		1 glass door; 3 drawers		2 glass doors; 3 drawers		
	35.2 cm wide		52.8 cm wide		70.4 cm wide		105.6 cm wide		
	Price gr.	33.0 cm deep	45.0 cm deep	33.0 cm deep	45.0 cm deep	33.0 cm deep	45.0 cm deep	33.0 cm deep	45.0 cm deep
		<b>832341 L</b> <b>832342 R</b>	<b>83241 L</b> <b>83242 R</b>	<b>852341 L</b> <b>852342 R</b>	<b>85241 L</b> <b>85242 R</b>	<b>872341 L</b> <b>872342 R</b>	<b>87241 L</b> <b>87242 R</b>	<b>810234</b>	<b>81024</b>
	I	-	-	-	-	-	-	-	-
	II	-	-	-	-	-	-	-	-
	1 glass door		1 glass door		1 glass door		2 glass doors		
	35.2 cm wide		52.8 cm wide		70.4 cm wide		105.6 cm wide		
Price gr.	33.0 cm deep	45.0 cm deep	33.0 cm deep	45.0 cm deep	33.0 cm deep	45.0 cm deep	33.0 cm deep	45.0 cm deep	
	<b>835341 L</b> <b>835342 R</b>	<b>83541 L</b> <b>83542 R</b>	<b>855341 L</b> <b>855342 R</b>	<b>85541 L</b> <b>85542 R</b>	<b>875341 L</b> <b>875342 R</b>	<b>87541 L</b> <b>87542 R</b>	<b>810534</b>	<b>81054</b>	
I	-	-	-	-	-	-	-	-	
II	-	-	-	-	-	-	-	-	
1 door/glass door		1 door/glass door		1 door/glass door		2 doors/glass doors			
35.2 cm wide		52.8 cm wide		70.4 cm wide		105.6 cm wide			
Price gr.	33.0 cm deep	45.0 cm deep	33.0 cm deep	45.0 cm deep	33.0 cm deep	45.0 cm deep	33.0 cm deep	45.0 cm deep	
	<b>833341 L</b> <b>833342 R</b>	<b>83341 L</b> <b>83342 R</b>	<b>853341 L</b> <b>853342 R</b>	<b>85341 L</b> <b>85342 R</b>	<b>873341 L</b> <b>873342 R</b>	<b>87341 L</b> <b>87342 R</b>	<b>810334</b>	<b>81034</b>	
I	-	-	-	-	-	-	-	-	
II	-	-	-	-	-	-	-	-	
		1 door/glass door		1 door/glass door		2 doors/glass doors			
		52.8 cm wide		70.4 cm wide		105.6 cm wide			
Price gr.	33.0 cm deep	45.0 cm deep	33.0 cm deep	45.0 cm deep	33.0 cm deep	45.0 cm deep	33.0 cm deep	45.0 cm deep	
	<b>854341 L</b> <b>854342 R</b>	<b>85441 L</b> <b>85442 R</b>	<b>874341 L</b> <b>874342 R</b>	<b>87441 L</b> <b>87442 R</b>	<b>810434</b>	<b>81044</b>			
I	-	-	-	-	-	-	-	-	
II	-	-	-	-	-	-	-	-	
as illustr. (L) v. versa (R)									
Price gr.									
I									
II									

When used as wall units or stacked units:  
Max. load per unit: 40 kg

## Wall bracket

<p>If units are to be included as wall units, a wall bracket must be ordered. If units are stacked on top of one another, a wall bracket must only be ordered for the stacked unit(s) if the stacked unit is wider than the floor unit or if the units are stacked in an off-set position.</p>	for 35.2 cm width	for 52.8 cm width	for 70.4 cm width	for 105.6 cm width
	<b>4352</b>	<b>4528</b>	<b>4704</b>	<b>4105</b>
	-	-	-	-







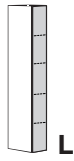
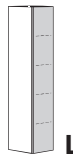
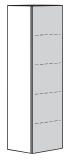
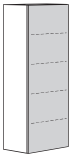
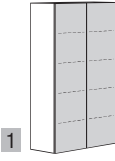
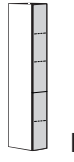
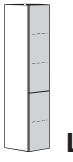
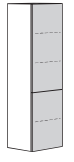

# 10 Raster units

Accessories: see pages 82-84.  
Lamps: see pages 86-87.

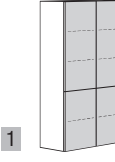
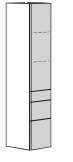
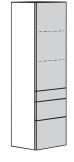
**10 Raster units**  
176.0 cm high  
(177.8 cm high incl. 1.8 cm high plinth adjusters),  
**33.0 or 45.0 cm deep**

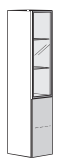
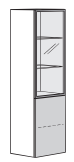
When used as wall units or stacked units:  
Max. load per unit: 40 kg

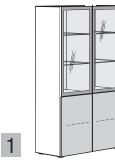
		1 door  17.6 cm wide		1 door  35.2 cm wide		1 door  52.8 cm wide		1 door  70.4 cm wide		2 doors  105.6 cm wide	
Price gr.		33.0 cm deep	45.0 cm deep	33.0 cm deep	45.0 cm deep	33.0 cm deep	45.0 cm deep	33.0 cm deep	45.0 cm deep	33.0 cm deep	45.0 cm deep
	I	1013311 L	101311 L	1032311 L	103211 L	1052311 L	105211 L	1072311 L	107211 L	1010231	101021
II		-	-	-	-	-	-	-	-	-	-
		2 doors  17.6 cm wide		2 doors  35.2 cm wide		2 doors  52.8 cm wide		2 doors  70.4 cm wide		4 doors  105.6 cm wide	
Price gr.		33.0 cm deep	45.0 cm deep	33.0 cm deep	45.0 cm deep	33.0 cm deep	45.0 cm deep	33.0 cm deep	45.0 cm deep	33.0 cm deep	45.0 cm deep
	I	1014311 L	101411 L	1033311 L	103311 L	1053311 L	105311 L	1073311 L	107311 L	1010331	101031
II		-	-	-	-	-	-	-	-	-	-
		1 door; 3 drawers  35.2 cm wide		1 door; 3 drawers  52.8 cm wide		1 door; 3 drawers  70.4 cm wide		2 doors; 3 drawers  105.6 cm wide			
Price gr.		33.0 cm deep	45.0 cm deep	33.0 cm deep	45.0 cm deep	33.0 cm deep	45.0 cm deep	33.0 cm deep	45.0 cm deep	33.0 cm deep	45.0 cm deep
	I	1034311 L	103411 L	1054311 L	105411 L	1074311 L	107411 L	1010431	101041		
II		-	-	-	-	-	-	-	-	-	-
		1 glass door; 1 door  35.2 cm wide		1 glass door; 1 door  52.8 cm wide		1 glass door; 1 door  70.4 cm wide		2 glass doors; 2 doors  105.6 cm wide			
Price gr.		33.0 cm deep	45.0 cm deep	33.0 cm deep	45.0 cm deep	33.0 cm deep	45.0 cm deep	33.0 cm deep	45.0 cm deep	33.0 cm deep	45.0 cm deep
	I	1031341 L	103141 L	1051341 L	105141 L	1071341 L	107141 L	1010134	101014		
II		-	-	-	-	-	-	-	-	-	-

## Wall bracket

If units are to be included as wall units, a wall bracket must be ordered. If units are stacked on top of one another, a wall bracket must only be ordered for the stacked unit(s) if the stacked unit is wider than the floor unit or if the units are stacked in an off-set position.	for 17.6 cm width	for 35.2 cm width	for 52.8 cm width	for 70.4 cm width	for 105.6 cm width
	4170	4352	4528	4704	4105
	-	-	-	-	-

L/R = Door hinge left/right

E 5.2018

Wohnen: NEO







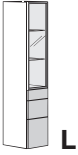
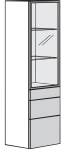
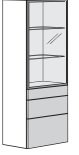

**Notes on delivery:**  
Please see here the information on range introduction pages.

**Assembly notes for wall units:**  
Please be sure to note here the information and notes in the "Wall composition" chapter!

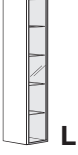
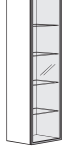
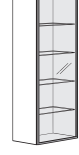
# 10 Raster units

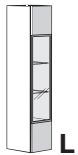
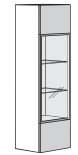
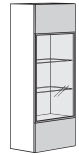
NEO

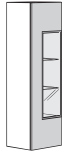
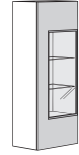
**10 Raster units**  
176.0 cm high  
(177.8 cm high incl. 1.8 cm high plinth adjusters),  
**33.0 or 45.0 cm deep**

	1 glass door; 3 drawers		1 glass door; 3 drawers		1 glass door; 3 drawers		2 glass doors; 3 drawers	
								
	35.2 cm wide		52.8 cm wide		70.4 cm wide		105.6 cm wide	
Price gr.	33.0 cm deep	45.0 cm deep	33.0 cm deep	45.0 cm deep	33.0 cm deep	45.0 cm deep	33.0 cm deep	45.0 cm deep
	<b>1032341 L</b> <b>1032342 R</b>	<b>103241 L</b> <b>103242 R</b>	<b>1052341 L</b> <b>1052342 R</b>	<b>105241 L</b> <b>105242 R</b>	<b>1072341 L</b> <b>1072342 R</b>	<b>107241 L</b> <b>107242 R</b>	<b>1010234</b>	<b>101024</b>
I	-	-	-	-	-	-	-	-
II	-	-	-	-	-	-	-	-
	1 glass door		1 glass door		1 glass door		2 glass doors	
								
	35.2 cm wide		52.8 cm wide		70.4 cm wide		105.6 cm wide	
Price gr.	33.0 cm deep	45.0 cm deep	33.0 cm deep	45.0 cm deep	33.0 cm deep	45.0 cm deep	33.0 cm deep	45.0 cm deep
	<b>1035341 L</b> <b>1035342 R</b>	<b>103541 L</b> <b>103542 R</b>	<b>1055341 L</b> <b>1055342 R</b>	<b>105541 L</b> <b>105542 R</b>	<b>1075341 L</b> <b>1075342 R</b>	<b>107541 L</b> <b>107542 R</b>	<b>1010534</b>	<b>101054</b>
I	-	-	-	-	-	-	-	-
II	-	-	-	-	-	-	-	-
	1 door/glass door		1 door/glass door		1 door/glass door		2 doors/glass doors	
								
	35.2 cm wide		52.8 cm wide		70.4 cm wide		105.6 cm wide	
Price gr.	33.0 cm deep	45.0 cm deep	33.0 cm deep	45.0 cm deep	33.0 cm deep	45.0 cm deep	33.0 cm deep	45.0 cm deep
	<b>1033341 L</b> <b>1033342 R</b>	<b>103341 L</b> <b>103342 R</b>	<b>1053341 L</b> <b>1053342 R</b>	<b>105341 L</b> <b>105342 R</b>	<b>1073341 L</b> <b>1073342 R</b>	<b>107341 L</b> <b>107342 R</b>	<b>1010334</b>	<b>101034</b>
I	-	-	-	-	-	-	-	-
II	-	-	-	-	-	-	-	-
			1 door/glass door		1 door/glass door		2 doors/glass doors	
								
			52.8 cm wide		70.4 cm wide		105.6 cm wide	
Price gr.	33.0 cm deep	45.0 cm deep	33.0 cm deep	45.0 cm deep	33.0 cm deep	45.0 cm deep	33.0 cm deep	45.0 cm deep
			<b>1054341 L</b> <b>1054342 R</b>	<b>105441 L</b> <b>105442 R</b>	<b>1074341 L</b> <b>1074342 R</b>	<b>107441 L</b> <b>107442 R</b>	<b>1010434</b>	<b>101044</b>
I			-	-	-	-	-	-
II			-	-	-	-	-	-
as illustr. (L) v. versa (R)			33.0 cm deep	45.0 cm deep	33.0 cm deep	45.0 cm deep	33.0 cm deep	45.0 cm deep
Price gr.								
I								
II								

When used as wall units or stacked units:  
Max. load per unit: 40 kg

## Wall bracket









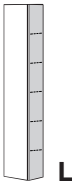
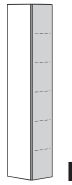
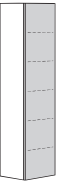
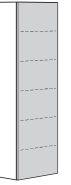

If units are to be included as wall units, a wall bracket must be ordered. If units are stacked on top of one another, a wall bracket must only be ordered for the stacked unit(s) if the stacked unit is wider than the floor unit or if the units are stacked in an off-set position.	for 35.2 cm width	for 52.8 cm width	for 70.4 cm width	for 105.6 cm width
	<b>4352</b>	<b>4528</b>	<b>4704</b>	<b>4105</b>
	-	-	-	-

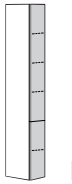
# 12 Raster units

Accessories: see pages 82-84.  
Lamps: see pages 86-87.

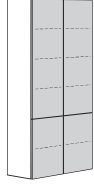
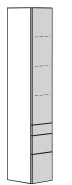
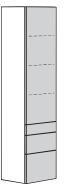
**12 Raster units**  
211.2 cm high  
(213.0 cm high incl. 1.8 cm high plinth adjusters),  
**33.0 or 45.0 cm deep**

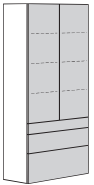
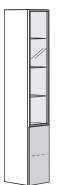
When used as wall units or stacked units:  
Max. load per unit: 40 kg

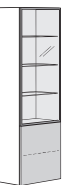
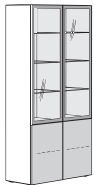
1 door										
	17.6 cm wide		35.2 cm wide		52.8 cm wide		70.4 cm wide		105.6 cm wide	
Price gr.	33.0 cm deep	45.0 cm deep	33.0 cm deep	45.0 cm deep	33.0 cm deep	45.0 cm deep	33.0 cm deep	45.0 cm deep	33.0 cm deep	45.0 cm deep
	1213311 L 1213312 R	121311 L 121312 R	1232311 L 1232312 R	123211 L 123212 R	1252311 L 1252312 R	125211 L 125212 R	1272311 L 1272312 R	127211 L 127212 R	1210231	121021
I	-	-	-	-	-	-	-	-	-	-
II	-	-	-	-	-	-	-	-	-	-
2 doors										
	17.6 cm wide		35.2 cm wide		52.8 cm wide		70.4 cm wide		105.6 cm wide	
Price gr.	33.0 cm deep	45.0 cm deep	33.0 cm deep	45.0 cm deep	33.0 cm deep	45.0 cm deep	33.0 cm deep	45.0 cm deep	33.0 cm deep	45.0 cm deep
	1214311 L 1214312 R	121411 L 121412 R	1233311 L 1233312 R	123311 L 123312 R	1253311 L 1253312 R	125311 L 125312 R	1273311 L 1273312 R	127311 L 127312 R	1210331	121031
I	-	-	-	-	-	-	-	-	-	-
II	-	-	-	-	-	-	-	-	-	-
1 door; 3 drawers										
	35.2 cm wide		52.8 cm wide		70.4 cm wide		105.6 cm wide			
Price gr.	33.0 cm deep		45.0 cm deep		33.0 cm deep		45.0 cm deep		33.0 cm deep	
	1234311 L 1234312 R		123411 L 123412 R		1254311 L 1254312 R		125411 L 125412 R		1274311 L 1274312 R	
I	-		-		-		-		-	
II	-		-		-		-		-	
1 glass door; 1 door										
	35.2 cm wide		52.8 cm wide		70.4 cm wide		105.6 cm wide			
Price gr.	33.0 cm deep		45.0 cm deep		33.0 cm deep		45.0 cm deep		33.0 cm deep	
	1231341 L 1231342 R		123141 L 123142 R		1251341 L 1251342 R		125141 L 125142 R		1271341 L 1271342 R	
I	-		-		-		-		-	
II	-		-		-		-		-	

## Wall bracket



If units are to be included as wall units, a wall bracket must be ordered. If units are stacked on top of one another, a wall bracket must only be ordered for the stacked unit(s) if the stacked unit is wider than the floor unit or if the units are stacked in an off-set position.	for 17.6 cm width	for 35.2 cm width	for 52.8 cm width	for 70.4 cm width	for 105.6 cm width
	4170	4352	4528	4704	4105
	-	-	-	-	-

**Notes on delivery:**  
Please see here the information on range introduction pages.

**Assembly notes for wall units:**  
Please be sure to note here the information and notes in the "Wall composition" chapter!

# 12 Raster units

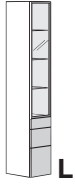
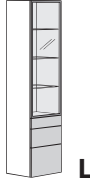
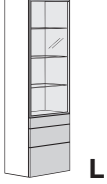
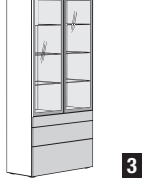
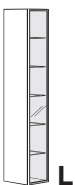
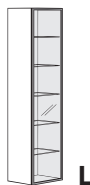
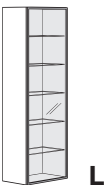
**12 Raster units**  
211.2 cm high  
(213.0 cm high incl. 1.8 cm high plinth adjusters),  
**33.0 or 45.0 cm deep**

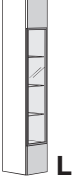
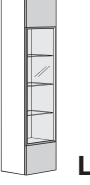
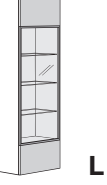
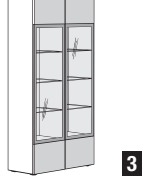
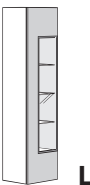
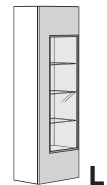
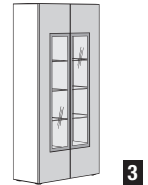
	1 glass door; 3 drawers  35.2 cm wide		1 glass door; 3 drawers  52.8 cm wide		1 glass door; 3 drawers  70.4 cm wide		2 glass doors; 3 drawers  105.6 cm wide	
Price gr.	33.0 cm deep	45.0 cm deep	33.0 cm deep	45.0 cm deep	33.0 cm deep	45.0 cm deep	33.0 cm deep	45.0 cm deep
	<b>1232341 L</b> <b>1232342 R</b>	<b>123241 L</b> <b>123242 R</b>	<b>1252341 L</b> <b>1252342 R</b>	<b>125241 L</b> <b>125242 R</b>	<b>1272341 L</b> <b>1272342 R</b>	<b>127241 L</b> <b>127242 R</b>	<b>1212234</b>	<b>121224</b>
I	-	-	-	-	-	-	-	-
II	-	-	-	-	-	-	-	-
	1 glass door  35.2 cm wide		1 glass door  52.8 cm wide		1 glass door  70.4 cm wide		2 glass doors  105.6 cm wide	
Price gr.	33.0 cm deep	45.0 cm deep	33.0 cm deep	45.0 cm deep	33.0 cm deep	45.0 cm deep	33.0 cm deep	45.0 cm deep
	<b>1235341 L</b> <b>1235342 R</b>	<b>123541 L</b> <b>123542 R</b>	<b>1255341 L</b> <b>1255342 R</b>	<b>125541 L</b> <b>125542 R</b>	<b>1275341 L</b> <b>1275342 R</b>	<b>127541 L</b> <b>127542 R</b>	<b>1210534</b>	<b>121054</b>
I	-	-	-	-	-	-	-	-
II	-	-	-	-	-	-	-	-
	1 door/glass door  35.2 cm wide		1 door/glass door  52.8 cm wide		1 door/glass door  70.4 cm wide		2 doors/glass doors  105.6 cm wide	
Price gr.	33.0 cm deep	45.0 cm deep	33.0 cm deep	45.0 cm deep	33.0 cm deep	45.0 cm deep	33.0 cm deep	45.0 cm deep
	<b>1233341 L</b> <b>1233342 R</b>	<b>123341 L</b> <b>123342 R</b>	<b>1253341 L</b> <b>1253342 R</b>	<b>125341 L</b> <b>125342 R</b>	<b>1273341 L</b> <b>1273342 R</b>	<b>127341 L</b> <b>127342 R</b>	<b>1210334</b>	<b>121034</b>
I	-	-	-	-	-	-	-	-
II	-	-	-	-	-	-	-	-
			1 door/glass door  52.8 cm wide		1 door/glass door  70.4 cm wide		2 doors/glass doors  105.6 cm wide	
Price gr.	as illustr. (L) v. versa (R)		33.0 cm deep	45.0 cm deep	33.0 cm deep	45.0 cm deep	33.0 cm deep	45.0 cm deep
			<b>1254341 L</b> <b>1254342 R</b>	<b>125441 L</b> <b>125442 R</b>	<b>1274341 L</b> <b>1274342 R</b>	<b>127441 L</b> <b>127442 R</b>	<b>1210434</b>	<b>121044</b>
I			-	-	-	-	-	-
II			-	-	-	-	-	-





When used as wall units or stacked units:  
Max. load per unit: 40 kg

## Wall bracket

If units are to be included as wall units, a wall bracket must be ordered. If units are stacked on top of one another, a wall bracket must only be ordered for the stacked unit(s) if the stacked unit is wider than the floor unit or if the units are stacked in an off-set position.	for 35.2 cm width	for 52.8 cm width	for 70.4 cm width	for 105.6 cm width
	<b>4352</b>	<b>4528</b>	<b>4704</b>	<b>4105</b>
	-	-	-	-

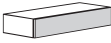
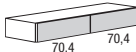
# 1 Raster lowboards: Floor units

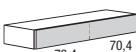
Accessories: see pages 82-84.

<p><b>1 Raster lowboards: Floor units</b> 17.6 cm high (19.4 cm high incl. 1.8 cm high plinth adjusters), <b>45.0 or 52.0 cm deep</b></p> <p>incl. cable aperture at centre of rear wall behind flap per compartment</p>	1 drawer		2 drawers			
						
	105.6 cm wide		140.8 cm wide			
	as illustr. v. versa	45.0 cm deep	52.0 cm deep	45.0 cm deep	52.0 cm deep	
		<b>10411</b>	<b>10511</b>	<b>14411</b>	<b>14511</b>	
	<b>Price gr.</b>	-	-	-	-	
	<b>I</b>	-	-	-	-	
	<b>II</b>	-	-	-	-	
	1 flap		1 flap			
						
105.6 cm wide		140.8 cm wide				
as illustr. v. versa	45.0 cm deep	52.0 cm deep	45.0 cm deep	52.0 cm deep		
	<b>10418</b>	<b>10518</b>	<b>14418</b>	<b>14518</b>		
<b>Price gr.</b>	-	-	-	-		
<b>I</b>	-	-	-	-		
<b>II</b>	-	-	-	-		
		1 drawer; 1 flap				
						
		140.8 cm wide				
as illustr. v. versa			45.0 cm deep	52.0 cm deep		
			<b>144281</b> <b>144282</b>	<b>145281</b> <b>145282</b>		
<b>Price gr.</b>			-	-		
<b>I</b>			-	-		
<b>II</b>			-	-		
		2 flaps				
						
		140.8 cm wide				
as illustr. v. versa			45.0 cm deep	52.0 cm deep		
			<b>14438</b>	<b>14538</b>		
<b>Price gr.</b>			-	-		
<b>I</b>			-	-		
<b>II</b>			-	-		

## Metal substructures and glass cover shelves

Metal substructures and glass cover shelves see page 84.

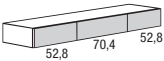
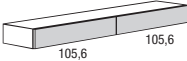
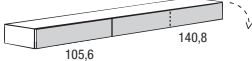
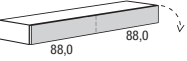
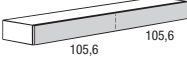
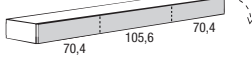
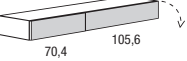
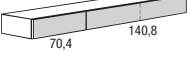
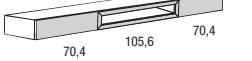
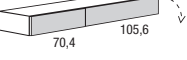
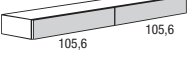
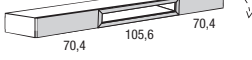

	3 drawers		2 drawers		1 drawer; 1 flap	
	 <p>176.0 cm wide</p>		 <p>211.2 cm wide</p>		 <p>246.4 cm wide</p>	
	45.0 cm deep	52.0 cm deep	45.0 cm deep	52.0 cm deep	45.0 cm deep	52.0 cm deep
	<b>17411</b>	<b>17511</b>	<b>11411</b>	<b>11511</b>	<b>134311</b> <b>134312</b>	<b>135311</b> <b>135312</b>
	-	-	-	-	-	-
	1 flap		1 flap		1 flap	
	 <p>176.0 cm wide</p>		 <p>211.2 cm wide</p>		 <p>246.4 cm wide</p>	
	45.0 cm deep	52.0 cm deep	45.0 cm deep	52.0 cm deep	45.0 cm deep	52.0 cm deep
	<b>17418</b>	<b>17518</b>	<b>11418</b>	<b>11518</b>	<b>13418</b>	<b>13518</b>
	-	-	-	-	-	-
	2 flaps		1 drawer; 1 flap		1 drawer; 1 open compartment; 1 drawer	
	 <p>176.0 cm wide</p>		 <p>211.2 cm wide</p>		 <p>246.4 cm wide</p>	
	45.0 cm deep	52.0 cm deep	45.0 cm deep	52.0 cm deep	45.0 cm deep	52.0 cm deep
	<b>174281</b> <b>174282</b>	<b>175281</b> <b>175282</b>	<b>114211</b> <b>114212</b>	<b>115211</b> <b>115212</b>	<b>13432</b>	<b>13532</b>
	-	-	-	-	-	-
	1 drawer; 1 flap		1 drawer; 1 flap		1 drawer; 1 open compartment; 1 flap	
	 <p>176.0 cm wide</p>		 <p>211.2 cm wide</p>		 <p>246.4 cm wide</p>	
	45.0 cm deep	52.0 cm deep	45.0 cm deep	52.0 cm deep	45.0 cm deep	52.0 cm deep
	<b>174211</b> <b>174212</b>	<b>175211</b> <b>175212</b>	<b>114311</b> <b>114312</b>	<b>115311</b> <b>115312</b>	<b>134321</b> <b>134322</b>	<b>135321</b> <b>135322</b>
	-	-	-	-	-	-

# 1 Raster lowboards: Floor units or as wall units

Accessories: see pages 82-84.

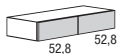
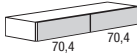
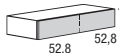
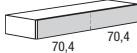
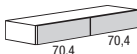
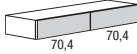
<p><b>1 Raster lowboards: Floor units or as wall units</b> 17.6 cm high (19.4 cm high incl. 1.8 cm high plinth adjusters), <b>33.0 or 45.0 cm deep</b> incl. cable aperture at centre of rear wall behind flap per compartment</p>	2 drawers		2 drawers		
					
	105.6 cm wide		140.8 cm wide		
	<b>Price gr.</b>	33.0 cm deep	45.0 cm deep	33.0 cm deep	45.0 cm deep
		<b>104231</b>	<b>10421</b>	<b>144131</b>	<b>14411</b>
	I	-	-	-	-
	II	-	-	-	-
	1 flap		1 flap		
					
	105.6 cm wide		140.8 cm wide		
as illustr. v. versa	33.0 cm deep	45.0 cm deep	33.0 cm deep	45.0 cm deep	
	<b>104238</b>	<b>10428</b>	<b>144138</b>	<b>14418</b>	
I	-	-	-	-	
II	-	-	-	-	
		1 drawer; 1 flap			
					
		140.8 cm wide			
as illustr. v. versa			33.0 cm deep	45.0 cm deep	
			<b>1442381</b> <b>1442382</b>	<b>144281</b> <b>144282</b>	
I			-	-	
II			-	-	
		2 flaps			
					
		140.8 cm wide			
When used as wall units or stacked units: Max. load 15 kg per metre: 105.6 cm width: 15.0 kg 140.8 cm width: 20.0 kg 176.0 cm width: 25.0 kg 211.2 cm width: 30.0 kg 246.4 cm width: 30.0 kg	as illustr. v. versa	33.0 cm deep	45.0 cm deep		
		<b>144338</b>	<b>14438</b>		
I		-	-		
II		-	-		

## Wall bracket

<p>If units are to be included as wall units, a wall bracket must be ordered. If units are stacked on top of one another, a wall bracket must only be ordered for the stacked unit(s) if the stacked unit is wider than the floor unit or if the units are stacked in an off-set position.</p>	for 105.6 cm width	for 140.8 cm width
	<b>4105</b>	<b>4140</b>
	-	-

## Metal substructures and glass cover shelves

Metal substructures and glass cover shelves see page 84.

Assembly notes for wall units:  
 Please be sure to note here the information  
 and notes in the "Wall composition" chapter!

**3**  
**4**

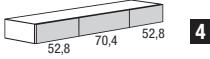
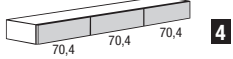
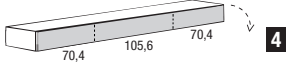
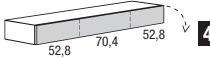
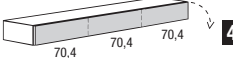
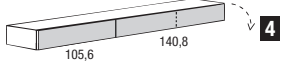
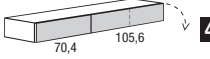
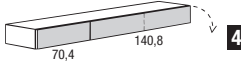
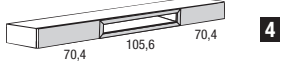
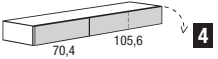
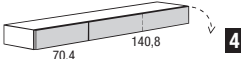
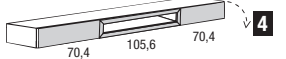
3 drawers		3 drawers		1 flap	
					
176.0 cm wide		211.2 cm wide		246.4 cm wide	
33.0 cm deep	45.0 cm deep	33.0 cm deep	45.0 cm deep	33.0 cm deep	45.0 cm deep
<b>174131</b>	<b>17411</b>	<b>114331</b>	<b>11431</b>	<b>13318</b>	<b>13418</b>
-	-	-	-	-	-
1 flap		1 flap		2 flaps	
					
176.0 cm wide		211.2 cm wide		246.4 cm wide	
33.0 cm deep	45.0 cm deep	33.0 cm deep	45.0 cm deep	33.0 cm deep	45.0 cm deep
<b>174238</b>	<b>17428</b>	<b>114238</b>	<b>11428</b>	<b>133331</b> <b>133332</b>	<b>134331</b> <b>134332</b>
-	-	-	-	-	-
1 drawer; 1 flap		1 drawer; 1 flap		1 drawer; 1 open compartment; 1 drawer	
					
176.0 cm wide		211.2 cm wide		246.4 cm wide	
33.0 cm deep	45.0 cm deep	33.0 cm deep	45.0 cm deep	33.0 cm deep	45.0 cm deep
<b>1743311</b> <b>1743312</b>	<b>174311</b> <b>174312</b>	<b>1142311</b> <b>1142312</b>	<b>114211</b> <b>114212</b>	<b>13332</b>	<b>13432</b>
-	-	-	-	-	-
2 flaps		2 flaps		1 drawer; 1 open compartment; 1 flap	
					
176.0 cm wide		211.2 cm wide		246.4 cm wide	
33.0 cm deep	45.0 cm deep	33.0 cm deep	45.0 cm deep	33.0 cm deep	45.0 cm deep
<b>1743381</b> <b>1743382</b>	<b>174381</b> <b>174382</b>	<b>1143381</b> <b>1143382</b>	<b>114381</b> <b>114382</b>	<b>133321</b> <b>133322</b>	<b>134321</b> <b>134322</b>
-	-	-	-	-	-
for 176.0 cm width		for 211.2 cm width		for 264.0 cm width	
<b>4176</b>		<b>4211</b>		<b>4246</b>	
-		-		-	

## 2 Raster lowboards: Floor units

Accessories: see pages 82-84.

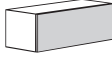
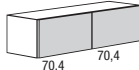
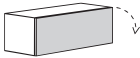
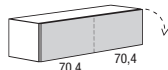
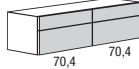
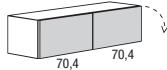
<p><b>2 Raster lowboards: Floor units</b> 35.2 cm high (37.0 cm high incl. 1.8 cm high plinth adjusters), <b>45.0 cm or 52.0 cm deep</b></p> <p>incl. cable aperture at centre of rear wall behind flap per compartment</p>	1 drawer		2 drawers			
						
	105.6 cm wide		140.8 cm wide			
	as illustr. v. versa	45.0 cm deep	52.0 cm deep	45.0 cm deep	52.0 cm deep	
		<b>20411</b>	<b>20511</b>	<b>24411</b>	<b>24511</b>	
	<b>Price gr.</b>	-	-	-	-	
	<b>I</b>	-	-	-	-	
	<b>II</b>	-	-	-	-	
	1 flap		1 flap			
						
105.6 cm wide		140.8 cm wide				
as illustr. v. versa	45.0 cm deep	52.0 cm deep	45.0 cm deep	52.0 cm deep		
	<b>20418</b>	<b>20518</b>	<b>24418</b>	<b>24518</b>		
<b>Price gr.</b>	-	-	-	-		
<b>I</b>	-	-	-	-		
<b>II</b>	-	-	-	-		
		4 drawers				
						
		140.8 cm wide				
as illustr. v. versa			45.0 cm deep	52.0 cm deep		
			<b>24421</b>	<b>24521</b>		
<b>Price gr.</b>			-	-		
<b>I</b>			-	-		
<b>II</b>			-	-		
		1 drawer; 1 flap				
						
		140.8 cm wide				
as illustr. v. versa			45.0 cm deep	52.0 cm deep		
			<b>244281</b> <b>244282</b>	<b>245281</b> <b>245282</b>		
<b>Price gr.</b>			-	-		
<b>I</b>			-	-		
<b>II</b>			-	-		

## Metal substructures and glass cover shelves

Metal substructures and glass cover shelves see page 84.

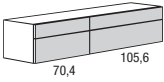
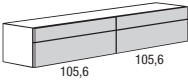
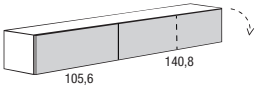
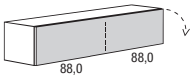
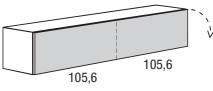
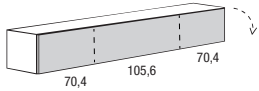
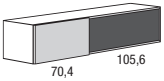
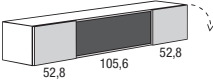
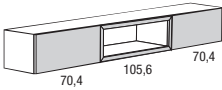
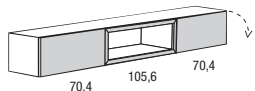
	4 drawers		4 drawers		1 drawer; 1 flap	
						
	176.0 cm wide		211.2 cm wide		246.4 cm wide	
	45.0 cm deep	52.0 cm deep	45.0 cm deep	52.0 cm deep	45.0 cm deep	52.0 cm deep
	<b>274211</b> <b>274212</b>	<b>275211</b> <b>275212</b>	<b>21421</b>	<b>21521</b>	<b>234311</b> <b>234312</b>	<b>235311</b> <b>235312</b>
	-	-	-	-	-	-
	1 flap		1 flap		1 flap	
						
	176.0 cm wide		211.2 cm wide		246.4 cm wide	
	45.0 cm deep	52.0 cm deep	45.0 cm deep	52.0 cm deep	45.0 cm deep	52.0 cm deep
	<b>27418</b>	<b>27518</b>	<b>21418</b>	<b>21518</b>	<b>23418</b>	<b>23518</b>
	-	-	-	-	-	-
	1 drawer; 1 fabric covered flap		1 drawer; 1 fabric covered flap; 1 flap		1 drawer; 1 open compartment; 1 drawer	
						
	176.0 cm wide		211.2 cm wide		246.4 cm wide	
	45.0 cm deep	52.0 cm deep	45.0 cm deep	52.0 cm deep	45.0 cm deep	52.0 cm deep
	<b>274161</b> <b>274162</b>	<b>275161</b> <b>275162</b>	<b>214161</b> <b>214162</b>	<b>215161</b> <b>215162</b>	<b>23432</b>	<b>23532</b>
	-	-	-	-	-	-
					1 drawer; 1 open compartment; 1 flap	
						
					246.4 cm wide	
					45.0 cm deep	52.0 cm deep
					<b>234321</b> <b>234322</b>	<b>235321</b> <b>235322</b>
					-	-

## 2 Raster lowboards: Floor units or as wall units

Accessories: see pages 82-84.

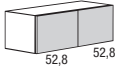
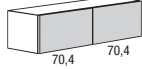
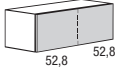
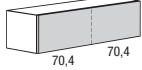
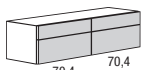
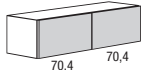
<p><b>2 Raster lowboards: Floor units or as wall units</b> 35.2 cm high (37.0 cm high incl. 1.8 cm high plinth adjusters), <b>33.0 or 45.0 cm deep</b> incl. cable aperture at centre of rear wall behind flap per compartment</p>	2 drawers		2 drawers		
					
	105.6 cm wide		140.8 cm wide		
	as illustr. v. versa	33.0 cm deep	45.0 cm deep	33.0 cm deep	45.0 cm deep
		<b>204331</b>	<b>20431</b>	<b>244131</b>	<b>24411</b>
	<b>Price gr.</b>	-	-	-	-
	<b>I</b>	-	-	-	-
	<b>II</b>	-	-	-	-
1 flap		1 flap			
					
105.6 cm wide		140.8 cm wide			
as illustr. v. versa	33.0 cm deep	45.0 cm deep	33.0 cm deep	45.0 cm deep	
	<b>204338</b>	<b>20438</b>	<b>244138</b>	<b>24418</b>	
<b>Price gr.</b>	-	-	-	-	
<b>I</b>	-	-	-	-	
<b>II</b>	-	-	-	-	
		4 drawers			
					
		140.8 cm wide			
as illustr. v. versa			33.0 cm deep	45.0 cm deep	
			<b>244231</b>	<b>24421</b>	
<b>Price gr.</b>			-	-	
<b>I</b>			-	-	
<b>II</b>			-	-	
		1 drawer; 1 flap			
					
		140.8 cm wide			
When used as wall units or stacked units: Max. load 15 kg per metre: 105.6 cm width: 15.0 kg 140.8 cm width: 20.0 kg 176.0 cm width: 25.0 kg 211.2 cm width: 30.0 kg 246.4 cm width: 30.0 kg	as illustr. v. versa			33.0 cm deep	45.0 cm deep
				<b>2442381</b> <b>2442382</b>	<b>244281</b> <b>244282</b>
<b>Price gr.</b>			-	-	
<b>I</b>			-	-	
<b>II</b>			-	-	

## Wall bracket

<p>If units are to be included as wall units, a wall bracket must be ordered. If units are stacked on top of one another, a wall bracket must only be ordered for the stacked unit(s) if the stacked unit is wider than the floor unit or if the units are stacked in an off-set position.</p>	for 105.6 cm width	for 140.8 cm width
	<b>4105</b>	<b>4140</b>
	-	-

## Metal substructures and glass cover shelves

Metal substructures and glass cover shelves see page 84.

Assembly notes for wall units:  
Please be sure to note here the information  
and notes in the "Wall composition" chapter!

**3**  
**4**

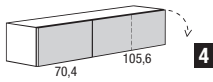
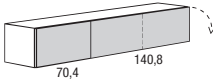
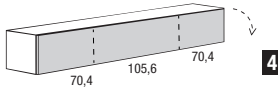
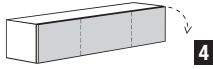
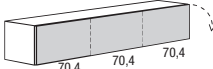
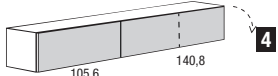
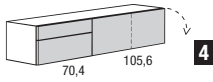
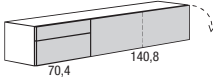
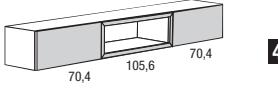
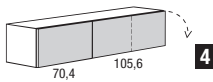
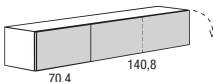
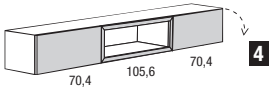
	1 drawer; 1 flap  176.0 cm wide		1 drawer; 1 flap  211.2 cm wide		1 flap  246.4 cm wide	
	33.0 cm deep	45.0 cm deep	33.0 cm deep	45.0 cm deep	33.0 cm deep	45.0 cm deep
	<b>2743311</b> <b>2743312</b>	<b>274311</b> <b>274312</b>	<b>2143311</b> <b>2143312</b>	<b>214311</b> <b>214312</b>	<b>23318</b>	<b>23418</b>
	-	-	-	-	-	-
	1 flap  176.0 cm wide		1 flap  211.2 cm wide		2 flaps  246.4 cm wide	
	33.0 cm deep	45.0 cm deep	33.0 cm deep	45.0 cm deep	33.0 cm deep	45.0 cm deep
	<b>274238</b>	<b>27428</b>	<b>214238</b>	<b>21428</b>	<b>233331</b> <b>233332</b>	<b>234331</b> <b>234332</b>
	-	-	-	-	-	-
	2 drawers; 1 flap  176.0 cm wide		2 drawers; 1 flap  211.2 cm wide		1 drawer; 1 open compartment; 1 drawer  246.4 cm wide	
	33.0 cm deep	45.0 cm deep	33.0 cm deep	45.0 cm deep	33.0 cm deep	45.0 cm deep
	<b>2744311</b> <b>2744312</b>	<b>274411</b> <b>274412</b>	<b>2144311</b> <b>2144312</b>	<b>214411</b> <b>214412</b>	<b>23332</b>	<b>23432</b>
	-	-	-	-	-	-
	2 flaps  176.0 cm wide		2 flaps  211.2 cm wide		1 drawer; 1 open compartment; 1 flap  246.4 cm wide	
	33.0 cm deep	45.0 cm deep	33.0 cm deep	45.0 cm deep	33.0 cm deep	45.0 cm deep
	<b>2743381</b> <b>2743382</b>	<b>274381</b> <b>274382</b>	<b>2143381</b> <b>2143382</b>	<b>214381</b> <b>214382</b>	<b>233321</b> <b>233322</b>	<b>234321</b> <b>234322</b>
	-	-	-	-	-	-
	for 176.0 cm width <b>4176</b>		for 211.2 cm width <b>4211</b>		for 264.0 cm width <b>4246</b>	
	-		-		-	

### 3 Raster lowboards: Floor units or as wall units

Accessories: see pages 82-84.

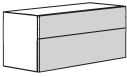
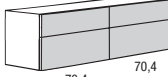
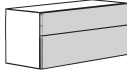
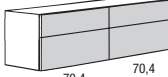
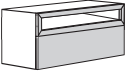
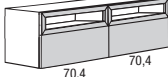
<p><b>3 Raster lowboards: Floor units or as wall units</b> 52.8 cm high (56.6 cm high incl. 1.8 cm high plinth adjusters), <b>45.0 cm or 52.0 cm deep</b></p> <p>incl. cable aperture at centre of rear wall behind flap per compartment</p> <p><b>52.0 cm deep lowboards cannot be used as wall units!</b></p>	2 drawers		4 drawers			
						
	105.6 cm wide		140.8 cm wide			
	as illustr. v. versa	45.0 cm deep	52.0 cm deep	45.0 cm deep	52.0 cm deep	
		<b>30451</b>	<b>30551</b>	<b>34451</b>	<b>34551</b>	
	<b>Price gr.</b>	I	-	-	-	
		II	-	-	-	
	1 flap; 1 drawer		2 flaps; 2 drawers			
						
	105.6 cm wide		140.8 cm wide			
	as illustr. v. versa	45.0 cm deep	52.0 cm deep	45.0 cm deep	52.0 cm deep	
		<b>30461</b>	<b>30561</b>	<b>34461</b>	<b>34561</b>	
<b>Price gr.</b>	I	-	-	-		
	II	-	-	-		
1 open compartment; 1 drawer		2 open compartments; 2 drawers				
						
105.6 cm wide		140.8 cm wide				
When used as wall units or stacked units: Max. load 15 kg per metre: 105.6 cm width: 15.0 kg 140.8 cm width: 20.0 kg 176.0 cm width: 25.0 kg 211.2 cm width: 30.0 kg 246.4 cm width: 30.0 kg	45.0 cm deep	52.0 cm deep	45.0 cm deep	52.0 cm deep		
	<b>30471</b>	<b>30571</b>	<b>34471</b>	<b>34571</b>		
<b>Price gr.</b>	I	-	-	-		
	II	-	-	-		

### Wall bracket

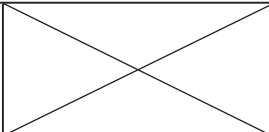
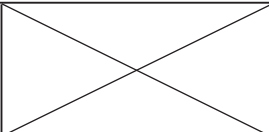
<p>If units are to be included as wall units, a wall bracket must be ordered. If units are stacked on top of one another, a wall bracket must only be ordered for the stacked unit(s) if the stacked unit is wider than the floor unit or if the units are stacked in an off-set position.</p>	for 105.6 cm width		for 140.8 cm width		
	<b>4105</b>		<b>4140</b>		
	-		-		

### Metal substructures and glass cover shelves

Metal substructures and glass cover shelves see page 84.

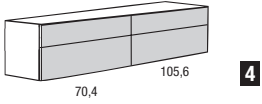
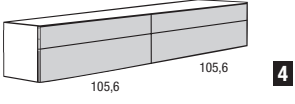
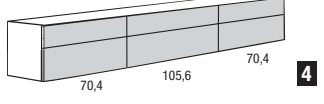
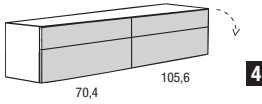
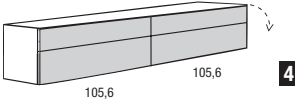
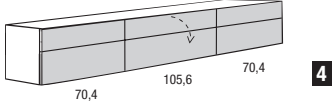
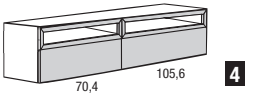
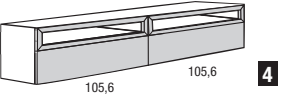
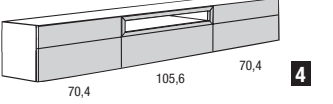

Assembly notes for wall units:  
Please be sure to note here the information  
and notes in the "Wall composition" chapter!

	4 drawers		4 drawers		6 drawers	
						
	176.0 cm wide		211.2 cm wide		246.4 cm wide	
	45.0 cm deep	52.0 cm deep	45.0 cm deep	52.0 cm deep	45.0 cm deep	52.0 cm deep
	<b>374251</b> <b>374252</b>	<b>375251</b> <b>375252</b>	<b>31451</b>	<b>31551</b>	<b>32451</b>	<b>32551</b>
	-	-	-	-	-	-
	2 flaps; 2 drawers		2 flaps; 2 drawers		2 drawers; 1 flap, 1 drawer; 2 drawers	
						
	176.0 cm wide		211.2 cm wide		246.4 cm wide	
	45.0 cm deep	52.0 cm deep	45.0 cm deep	52.0 cm deep	45.0 cm deep	52.0 cm deep
	<b>374261</b> <b>374262</b>	<b>375261</b> <b>375262</b>	<b>31461</b>	<b>31561</b>	<b>32461</b>	<b>32561</b>
	-	-	-	-	-	-
	2 open compartments; 2 drawers		2 open compartments; 2 drawers		2 drawers; 1 open compartment, 1 drawer; 2 drawers	
						
	176.0 cm wide		211.2 cm wide		246.4 cm wide	
	45.0 cm deep	52.0 cm deep	45.0 cm deep	52.0 cm deep	45.0 cm deep	52.0 cm deep
	<b>374271</b> <b>374272</b>	<b>375271</b> <b>375272</b>	<b>31471</b>	<b>31571</b>	<b>32471</b>	<b>32571</b>
	-	-	-	-	-	-

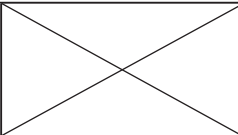
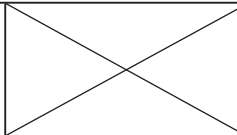
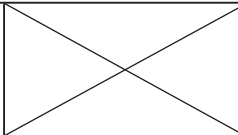
	for 176.0 cm width		for 211.2 cm width		for 264.0 cm width	
	<b>4176</b>		<b>4211</b>		<b>4246</b>	
	-		-		-	

# Media accessories for lowboards

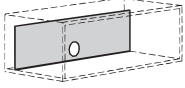
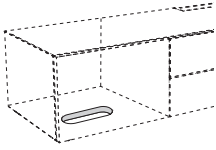
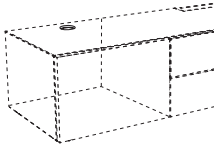
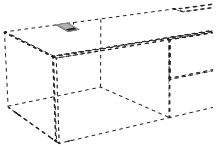
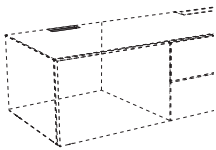
		for 105.6 cm width	for 140.8 cm width	for 176.0 cm width	for 211.2 cm width	for 246.4 cm width
		 <p><b>Rear wall with cable aperture and space for storing cables for lowboards with 2 Raster high compartments</b> Rear wall for feeding cables, plugs, etc. to make connections easier for all electrical media units in lowboards with 2 Raster high compartments. The standard rear wall is omitted and the price has been deducted.</p> <p>hülsta-Push-to-open with motor-driven support or Magic-Tronic cannot be used with the rear wall with cable aperture.</p> <p>Usable dims. of lowboards: Height: 31.4 cm Depth (45.0): 35.9 cm Depth (52.0): 42.9 cm</p>		<b>109</b>	<b>149</b>	<b>179</b>
	Price gr.	-	-	-	-	-
	I	-	-	-	-	-
	II	-	-	-	-	-
 <p><b>Subwoofer base cut-out section</b> Base cut-out section 12 x 23.2 cm; The sounds from the subwoofer pass out through the base cut-out section in the lowboard without hindrance. The exact position in the carcass is predetermined ex-works and cannot be altered.</p>						<b>14</b>
						-
 <p><b>Cable aperture K1</b> Silver-coloured; Ø 8.0 cm; It is possible to fit a cable aperture in the top shelf of the lowboard. The cable aperture can be made at the rear of the top shelf. The position is in the centre of the compartment, distance from centre of aperture to rear edge of unit: 10.0 cm.</p> <p>If media panels are fitted on a lowboard, please state the exact position of the cable aperture in the order.</p>						<b>K1</b>
						-
 <p><b>Cable aperture K7</b> Silver-coloured; 7.0 x 12.0 cm; It is possible to fit a cable aperture in the top shelf of the lowboard. The position is in the centre of the compartment, flush with the rear edge of the unit.</p> <p>If media panels are fitted on a lowboard, please state the exact position of the cable aperture in the order.</p>						<b>K7</b>
						-
 <p><b>Cable aperture K8</b> Silver-coloured; 12.8 x 3.2 cm; It is possible to fit a cable aperture in the top shelf of the lowboard. The cable aperture can be made at the rear rim of the top shelf. Positioned in centre of compartment.</p> <p>If media panels are fitted on a lowboard, please state the exact position of the cable aperture in the order.</p> <p>The cable aperture K8 cannot be fitted above an open compartment.</p>						<b>K8</b>
						-

### Multiple socket

**Multiple socket**

Can be fitted in the lowboard in front of the rear wall optionally left (L) or right (R) in the compartment behind the fabric-covered flap, switch can be fitted in wooden cover shelf optionally left or right (see sketch) or possible when fitting an optional glass cover shelf in the left or right outer carcass side of the lowboards.

Please state the required position clearly in the order!

7.4 cm high, 44.6 cm long, 5.7 cm deep

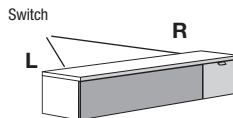

<b>Multiple socket with on/off function</b> continuous current all 6 sockets
<b>291 L</b> <b>292 R</b>
-

### IR repeater set

**IR repeater set**

Infrared signal transmission set for operating media units behind wooden/lacquered fronts. You can operate all the units in one compartment with one set. The following applies:

- One set must be used in each compartment. 2 transmitters can also be installed in large compartments in order to increase performance. In this case only one additional transmitter needs to be ordered.
- The transmitter must be placed in the direct vicinity of the receiver eye.
- Transmittable IR frequency band 20 – 60 kHz
- Up to 3 transmitters can be combined with one receiver.

It is possible to use 3 transmitters via 1 receiver including Master box. This enables simultaneous operation of 3 different furniture compartments or in critical situations it allows fitting out one furniture compartment with several transmitters in order to increase the performance in this compartment or to operate 2 end units placed next to one another.

The IR repeater set consists of:

- 1 receiver eye (Ø 3.0 cm) incl. standing bracket
- 1 electrical transmitter
- 1 plug EVG 12 V
- Cable clips

Please note the details stated in the operating instructions!

<b>IR repeater set</b> 1 receiver eye and 1 transmitter incl. standing bracket
<b>2001</b>
-
<b>Extra transmitter</b> <b>2003</b>
-

### TV columns

**TV columns** can be rotated and adjusted in angle, for fitting on **floor lowboards with partition** (not possible with 2 Raster lowboards with 2 drawers on top of one another and wall lowboards).

The TV column can only be fitted above a partition in the centre. The partition is provided with a cut-out section for cables (no surcharge). No drawers are possible below the TV column.

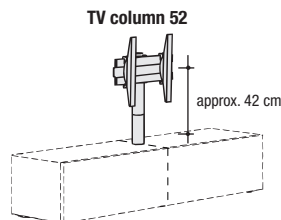

The revolving TV column 52 is suitable for flat screens with a screen diagonal of 38"-52" (96-132 cm), max. load: 35 kg  
TV revolving column 52 compatible with VESA Norm standard:  
min. 75 x 75 mm, max. 400 x 400 mm

The revolving TV column 65 is suitable for flat screens with a screen diagonal of 38"-65" (96-165 cm), max. load: 40 kg  
TV revolving column 65 compatible with VESA Norm standard:  
min. 75 x 75 mm, max. 800 x 400 mm

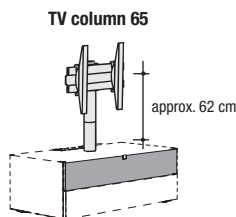

<b>TV column 52</b>	<b>TV column 65</b>
<b>9404</b>	<b>9403</b>
-	-

## 4 Raster sideboards: Floor units or as wall units

Accessories: see pages 82-84.  
Lamps: see pages 86-87.

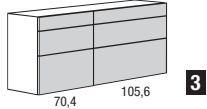
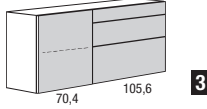
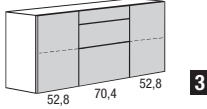
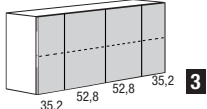
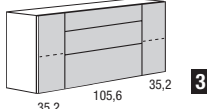
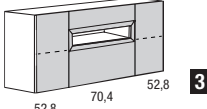
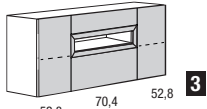
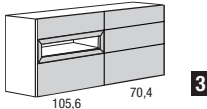
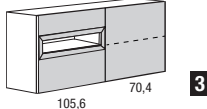
<p><b>4 Raster sideboards: Floor units or as wall units</b> 70.4 cm high (72.2 cm high incl. 1.8 cm high plinth adjusters), 45.0 or 52.0 cm deep</p>	6 drawers		1 door; 3 drawers		1 door; 3 drawers, 1 door		
							
	176.0 cm wide		176.0 cm wide		176.0 cm wide		
		45.0 cm deep	52.0 cm deep	45.0 cm deep	52.0 cm deep	45.0 cm deep	52.0 cm deep
	as illustr. v. versa	<b>417121</b> <b>417122</b>	<b>417111</b> <b>417112</b>	<b>417221</b> <b>417222</b>	<b>417211</b> <b>417212</b>	<b>41732</b>	<b>41731</b>
	Price gr.						
	I	-	-	-	-	-	-
	II	-	-	-	-	-	-
	4 doors		1 door; 3 drawers, 1 door		1 door; 2 drawers, 1 open compartment; 1 door		
							
176.0 cm wide		176.0 cm wide		176.0 cm wide			
	45.0 cm deep	52.0 cm deep	45.0 cm deep	52.0 cm deep	45.0 cm deep	52.0 cm deep	
Price gr.	<b>41742</b>	<b>41741</b>	<b>41752</b>	<b>41751</b>	<b>41762</b>	<b>41761</b>	
I	-	-	-	-	-	-	
II	-	-	-	-	-	-	
1 door; 2 drawers, 1 open compartment; 1 door		2 drawers, 1 open compartment; 3 drawers		2 drawers, 1 open compartment; 1 door			
							
176.0 cm wide		176.0 cm wide		176.0 cm wide			
	45.0 cm deep	52.0 cm deep	45.0 cm deep	52.0 cm deep	45.0 cm deep	52.0 cm deep	
as illustr. v. versa	<b>41772</b>	<b>41771</b>	<b>417721</b> <b>417722</b>	<b>417711</b> <b>417712</b>	<b>417421</b> <b>417422</b>	<b>417411</b> <b>417412</b>	
Price gr.							
I	-	-	-	-	-	-	
II	-	-	-	-	-	-	

When used as wall units or stacked units:  
Max. load per unit: 40 kg

### Wall bracket

<p>If units are to be included as wall units, a wall bracket must be ordered. If units are stacked on top of one another, a wall bracket must only be ordered for the stacked unit(s) if the stacked unit is wider than the floor unit or if the units are stacked in an off-set position.</p>	for 176.0 cm width
	<b>4176</b>

### Metal substructures and glass cover shelves

Metal substructures and glass cover shelves see page 84.

# 4 Raster sideboards: Floor units or as wall units

**Notes on delivery:**  
Please see here the information on range introduction pages.

**Assembly notes for wall units:**  
Please be sure to note here the information and notes in the "Wall composition" chapter!

**NEO**

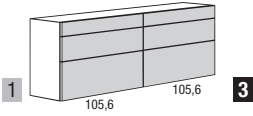
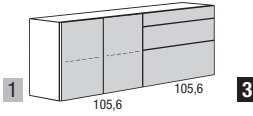
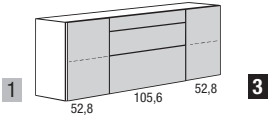
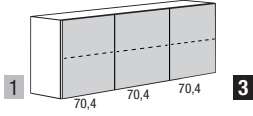
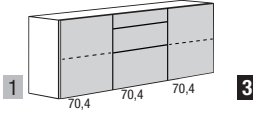
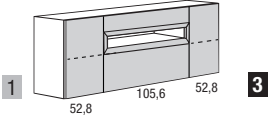
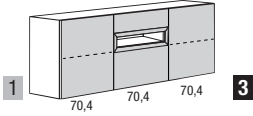
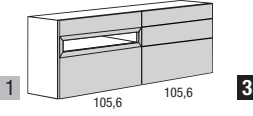
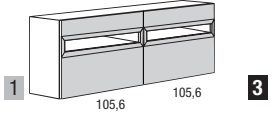
<b>4 Raster sideboards: Floor units or as wall units</b> 70.4 cm high (72.2 cm high incl. 1.8 cm high plinth adjusters), 45.0 or 52.0 cm deep	6 drawers		2 doors; 3 drawers		1 door; 3 drawers, 1 door	
					(cannot be used as a wall unit) 	
	211.2 cm wide		211.2 cm wide		211.2 cm wide	
		45.0 cm deep	52.0 cm deep	45.0 cm deep	52.0 cm deep	45.0 cm deep
as illustr. v. versa	<b>42112</b>	<b>42111</b>	<b>421221</b> <b>421222</b>	<b>421211</b> <b>421212</b>	<b>42132</b>	<b>42131</b>
<b>Price gr.</b>	-	-	-	-	-	-
<b>I</b>	-	-	-	-	-	-
<b>II</b>	-	-	-	-	-	-
<b>4 Raster sideboards: Floor units or as wall units</b> 70.4 cm high (72.2 cm high incl. 1.8 cm high plinth adjusters), 45.0 or 52.0 cm deep	3 doors		1 door; 3 drawers, 1 door		1 door; 2 drawers, 1 open compartment; 1 door	
			(cannot be used as a wall unit) 		(cannot be used as a wall unit) 	
	211.2 cm wide		211.2 cm wide		211.2 cm wide	
		45.0 cm deep	52.0 cm deep	45.0 cm deep	52.0 cm deep	45.0 cm deep
as illustr. v. versa	<b>42142</b>	<b>42141</b>	<b>42152</b>	<b>42151</b>	<b>42162</b>	<b>42161</b>
<b>Price gr.</b>	-	-	-	-	-	-
<b>I</b>	-	-	-	-	-	-
<b>II</b>	-	-	-	-	-	-
<b>4 Raster sideboards: Floor units or as wall units</b> 70.4 cm high (72.2 cm high incl. 1.8 cm high plinth adjusters), 45.0 or 52.0 cm deep	1 door; 2 drawers, 1 open compartment; 1 door		2 drawers, 1 open compartment; 3 drawers		4 drawers; 2 open compartments	
						
	211.2 cm wide		211.2 cm wide		211.2 cm wide	
		45.0 cm deep	52.0 cm deep	45.0 cm deep	52.0 cm deep	45.0 cm deep
as illustr. v. versa	<b>42172</b>	<b>42171</b>	<b>421721</b> <b>421722</b>	<b>421711</b> <b>421712</b>	<b>42192</b>	<b>42191</b>
<b>Price gr.</b>	-	-	-	-	-	-
<b>I</b>	-	-	-	-	-	-
<b>II</b>	-	-	-	-	-	-

When used as wall units or stacked units:  
Max. load per unit: 40 kg

## Wall bracket

If units are to be included as wall units, a wall bracket must be ordered. If units are stacked on top of one another, a wall bracket must only be ordered for the stacked unit(s) if the stacked unit is wider than the floor unit or if the units are stacked in an off-set position.	for 211.2 cm width
	<b>4211</b>

## Metal substructures and glass cover shelves

Metal substructures and glass cover shelves see page 84.

# 4 Raster sideboards: Floor units or as wall units

Accessories: see pages 82-84.  
Lamps: see pages 86-87.

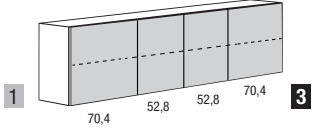
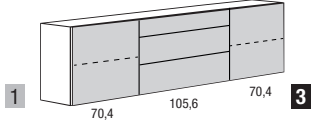
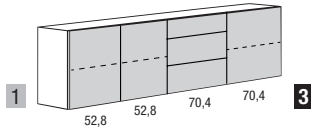
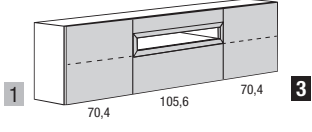
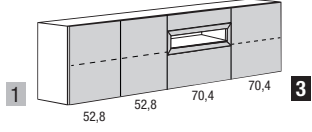
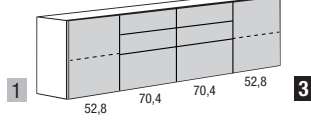
<p><b>4 Raster sideboards: Floor units or as wall units</b> 70.4 cm high (72.2 cm high incl. 1.8 cm high plinth adjusters), <b>45.0 or 52.0 cm deep</b></p>	4 doors		1 door; 3 drawers, 1 door		2 doors; 3 drawers; 1 door		
							
	246.4 cm wide		246.4 cm wide		246.4 cm wide		
		45.0 cm deep	52.0 cm deep	45.0 cm deep	52.0 cm deep	45.0 cm deep	52.0 cm deep
	as illustr. v. versa	<b>42442</b>	<b>42441</b>	<b>42452</b>	<b>42451</b>	<b>424521</b> <b>424522</b>	<b>424511</b> <b>424512</b>
	Price gr.	-	-	-	-	-	-
	I	-	-	-	-	-	-
	II	-	-	-	-	-	-
	1 door; 2 drawers, 1 open compartment; 1 door		2 doors; 2 drawers, 1 open compartment; 1 door		1 door; 6 drawers, 1 door		
							
246.4 cm wide		246.4 cm wide		246.4 cm wide			
	45.0 cm deep	52.0 cm deep	45.0 cm deep	52.0 cm deep	45.0 cm deep	52.0 cm deep	
	<b>42462</b>	<b>42461</b>	<b>424621</b> <b>424622</b>	<b>424611</b> <b>424612</b>	<b>42472</b>	<b>42471</b>	
Price gr.	-	-	-	-	-	-	
I	-	-	-	-	-	-	
II	-	-	-	-	-	-	
When used as wall units or stacked units: Max. load per unit: 40 kg							

## Wall bracket

<p>If units are to be included as wall units, a wall bracket must be ordered. If units are stacked on top of one another, a wall bracket must only be ordered for the stacked unit(s) if the stacked unit is wider than the floor unit or if the units are stacked in an off-set position.</p>	for 246.4 cm width
	<b>4246</b>

## Metal substructures and glass cover shelves

Metal substructures and glass cover shelves see page 84.

# 6 Raster highboards: Floor units or as wall units

**Notes on delivery:**  
Please see here the information on range introduction pages.

**Assembly notes for wall units:**  
Please be sure to note here the information and notes in the "Wall composition" chapter!

**NEO**

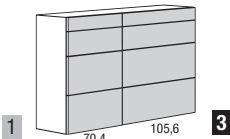
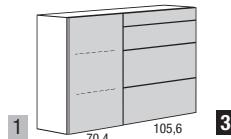
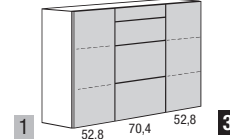
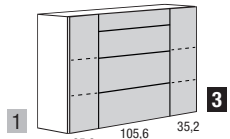
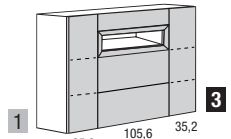
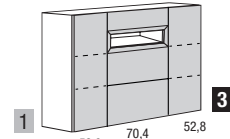
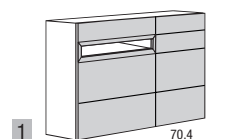
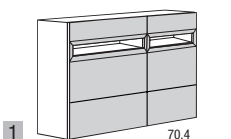
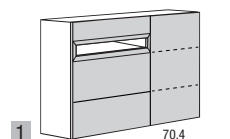
<p><b>6 Raster highboards: Floor units or as wall units</b> 105.6 cm high (107.4 cm high incl. 1.8 cm high plinth adjusters), 45.0 or 52.0 cm deep</p>	8 drawers		1 door; 4 drawers		1 door; 4 drawers, 1 door		
							
	176.0 cm wide		176.0 cm wide		176.0 cm wide		
		45.0 cm deep	52.0 cm deep	45.0 cm deep	52.0 cm deep	45.0 cm deep	52.0 cm deep
	as illustr. v. versa	<b>617121</b> <b>617122</b>	<b>617111</b> <b>617112</b>	<b>617221</b> <b>617222</b>	<b>617211</b> <b>617212</b>	<b>61732</b>	<b>61731</b>
	Price gr. I	-	-	-	-	-	-
	Price gr. II	-	-	-	-	-	-
	1 door; 4 drawers, 1 door		1 door; 3 drawers, 1 open compartment; 1 door		1 door; 3 drawers, 1 open compartment; 1 door		
	(cannot be used as a wall unit)		(cannot be used as a wall unit)				
							
176.0 cm wide		176.0 cm wide		176.0 cm wide			
	45.0 cm deep	52.0 cm deep	45.0 cm deep	52.0 cm deep	45.0 cm deep	52.0 cm deep	
Price gr. I	<b>61752</b>	<b>61751</b>	<b>61762</b>	<b>61761</b>	<b>61772</b>	<b>61771</b>	
Price gr. II	-	-	-	-	-	-	
3 drawers, 1 open compartment; 4 drawers		6 drawers; 2 open compartments		3 drawers, 1 open compartment; 1 door			
							
176.0 cm wide		176.0 cm wide		176.0 cm wide			
	45.0 cm deep	52.0 cm deep	45.0 cm deep	52.0 cm deep	45.0 cm deep	52.0 cm deep	
as illustr. v. versa	<b>617721</b> <b>617722</b>	<b>617711</b> <b>617712</b>	<b>617321</b> <b>617322</b>	<b>617311</b> <b>617312</b>	<b>617421</b> <b>617422</b>	<b>617411</b> <b>617412</b>	
Price gr. I	-	-	-	-	-	-	
Price gr. II	-	-	-	-	-	-	

When used as wall units or stacked units:  
Max. load per unit: 40 kg

## Wall bracket

If units are to be included as wall units, a wall bracket must be ordered. If units are stacked on top of one another, a wall bracket must only be ordered for the stacked unit(s) if the stacked unit is wider than the floor unit or if the units are stacked in an off-set position.

for 176.0 cm width

**4176**

## Metal substructures and glass cover shelves

Metal substructures and glass cover shelves see page 84.

# 6 Raster highboards: Floor units or as wall units

Accessories: see pages 82-84.  
Lamps: see pages 86-87.

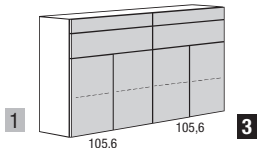
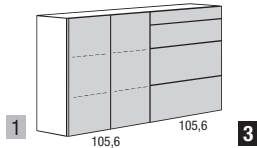
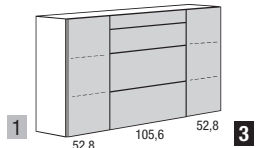
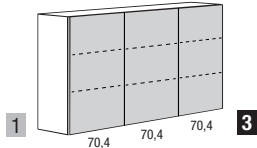
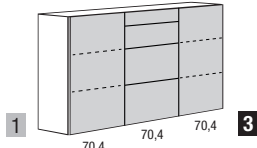
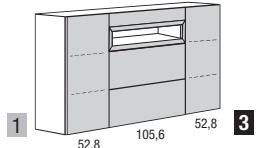
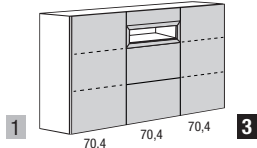
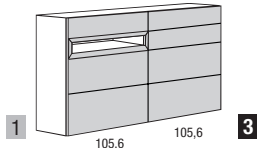
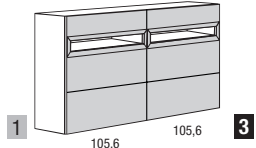
<b>6 Raster highboards: Floor units or as wall units</b> 105.6 cm high (107.4 cm high incl. 1.8 cm high plinth adjusters), <b>45.0 or 52.0 cm deep</b>	4 drawers; 4 doors		2 doors; 4 drawers		1 door; 4 drawers, 1 door	
	 211.2 cm wide		 211.2 cm wide		 211.2 cm wide (cannot be used as a wall unit)	
	45.0 cm deep	52.0 cm deep	45.0 cm deep	52.0 cm deep	45.0 cm deep	52.0 cm deep
as illustr. v. versa	<b>62112</b>	<b>62111</b>	<b>621221</b> <b>621222</b>	<b>621211</b> <b>621212</b>	<b>62132</b>	<b>62131</b>
<b>Price gr.</b>	-	-	-	-	-	-
<b>I</b>	-	-	-	-	-	-
<b>II</b>	-	-	-	-	-	-
	3 doors		1 door; 4 drawers, 1 door		1 door; 3 drawers, 1 open compartment; 1 door	
	 211.2 cm wide		 211.2 cm wide		 211.2 cm wide (cannot be used as a wall unit)	
	45.0 cm deep	52.0 cm deep	45.0 cm deep	52.0 cm deep	45.0 cm deep	52.0 cm deep
	<b>62142</b>	<b>62141</b>	<b>62152</b>	<b>62151</b>	<b>62162</b>	<b>62161</b>
<b>Price gr.</b>	-	-	-	-	-	-
<b>I</b>	-	-	-	-	-	-
<b>II</b>	-	-	-	-	-	-
	1 door; 3 drawers, 1 open compartment; 1 door		3 drawers, 1 open compartment; 4 drawers		6 drawers; 2 open compartments	
	 211.2 cm wide (cannot be used as a wall unit)		 211.2 cm wide		 211.2 cm wide	
	45.0 cm deep	52.0 cm deep	45.0 cm deep	52.0 cm deep	45.0 cm deep	52.0 cm deep
as illustr. v. versa	<b>62172</b>	<b>62171</b>	<b>621721</b> <b>621722</b>	<b>621711</b> <b>621712</b>	<b>62192</b>	<b>62191</b>
<b>Price gr.</b>	-	-	-	-	-	-
<b>I</b>	-	-	-	-	-	-
<b>II</b>	-	-	-	-	-	-

When used as wall units or stacked units:  
Max. load per unit: 40 kg

## Wall bracket

If units are to be included as wall units, a wall bracket must be ordered. If units are stacked on top of one another, a wall bracket must only be ordered for the stacked unit(s) if the stacked unit is wider than the floor unit or if the units are stacked in an off-set position.	for 211.2 cm width
	<b>4211</b>

## Metal substructures and glass cover shelves

Metal substructures and glass cover shelves see page 84.



# 6 Raster highboards: Floor units or as wall units

**Notes on delivery:**  
Please see here the information on range introduction pages.

**Assembly notes for wall units:**  
Please be sure to note here the information and notes in the "Wall composition" chapter!

**NEO**

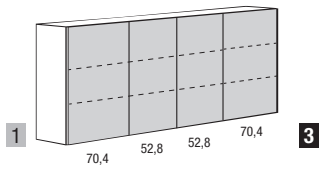
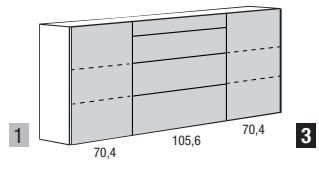
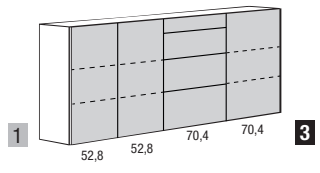
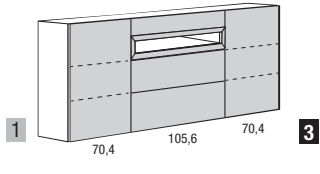
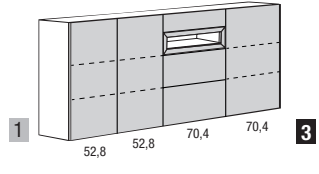
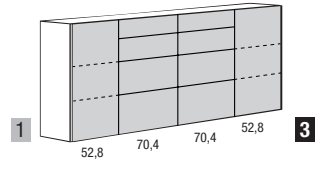
<p><b>6 Raster highboards: Floor units or as wall units</b> 105.6 cm high (107.4 cm high incl. 1.8 cm high plinth adjusters), <b>45.0 or 52.0 cm deep</b></p>	4 doors		1 door; 4 drawers; 1 door		2 doors; 4 drawers; 1 door		
							
	246.4 cm wide		246.4 cm wide		246.4 cm wide		
		45.0 cm deep	52.0 cm deep	45.0 cm deep	52.0 cm deep	45.0 cm deep	52.0 cm deep
	as illustr. v. versa	<b>62442</b>	<b>62441</b>	<b>62452</b>	<b>62451</b>	<b>624521</b> <b>624522</b>	<b>624511</b> <b>624512</b>
	<b>Price gr.</b>	-	-	-	-	-	-
	<b>I</b>	-	-	-	-	-	-
	<b>II</b>	-	-	-	-	-	-
	1 door; 3 drawers, 1 open compartment; 1 door		2 doors; 3 drawers, 1 open compartment; 1 door		1 door; 8 drawers, 1 door		
							
246.4 cm wide		246.4 cm wide		246.4 cm wide			
	45.0 cm deep	52.0 cm deep	45.0 cm deep	52.0 cm deep	45.0 cm deep	52.0 cm deep	
as illustr. v. versa	<b>62462</b>	<b>62461</b>	<b>624621</b> <b>624622</b>	<b>624611</b> <b>624612</b>	<b>62472</b>	<b>62471</b>	
<b>Price gr.</b>	-	-	-	-	-	-	
<b>I</b>	-	-	-	-	-	-	
<b>II</b>	-	-	-	-	-	-	
When used as wall units or stacked units: Max. load per unit: 40 kg							

## Wall bracket

<p>If units are to be included as wall units, a wall bracket must be ordered. If units are stacked on top of one another, a wall bracket must only be ordered for the stacked unit(s) if the stacked unit is wider than the floor unit or if the units are stacked in an off-set position.</p>	for 246.4 cm width
	<b>4246</b>

## Metal substructures and glass cover shelves

Metal substructures and glass cover shelves see page 84.

# 4 and 6 Raster side- and highboards: with hülsta-MagicDive – floor units

**Notes on delivery:**  
Please see here the information on range introduction pages.

1  
2

**Assembly notes for wall units:**  
Please be sure to note here the information and notes in the "Wall composition" chapter!

3  
4

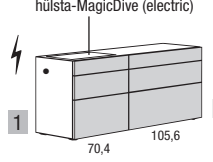
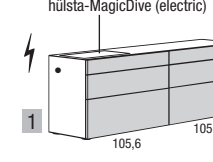
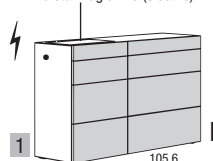
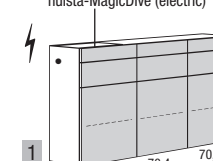
<p><b>4 Raster sideboards with hülsta-MagicDive: floor units</b> 70.4 cm high (72.2 cm high incl. 1.8 cm high plinth adjusters), <b>52.0 cm deep</b></p> <p>A storage compartment incl. fabric-lined tray and inside LED lamp, operated by <b>Magic-Tronic</b>, opens/closes by an electric drive when the hülsta-MagicDive in the cover shelf is pushed lightly.</p> <p>This luminaire contains built-in LED lamps of the energy classes A+++ to A. The lamps cannot be changed in the luminaire. 230 V; 1.0 W</p> <p><b>Wall units: 4 Raster sideboards with hülsta-MagicDive cannot be used as wall units.</b></p>	<p>with <b>hülsta-MagicDive</b> in cover shelf, optionally left (L) or right (R); 2 drawers each bottom left and right, 1 fixed panel each at top</p> <p>Usable sizes of storage compartment under cover shelf: Height: 9.4 cm Width: 60.8 cm; with integrated optional charging station: 48.4 cm Depth: 30.0 cm</p> <p>hülsta-MagicDive (electric)</p> <p>• = Position of Magic-Tronic sensor; in right side of right (R) unit</p>  <p>176.0 cm wide</p>		<p>with <b>hülsta-MagicDive</b> in cover shelf, optionally left (L) or right (R); 2 drawers each bottom left and right, 1 fixed panel each at top</p> <p>Usable sizes of storage compartment under cover shelf: Height: 9.4 cm Width: 60.8 cm; with integrated optional charging station: 48.4 cm Depth: 30.0 cm</p> <p>hülsta-MagicDive (electric)</p> <p>• = Position of Magic-Tronic sensor; in right side of right (R) unit</p>  <p>211.2 cm wide</p>		
	52.0 cm deep		52.0 cm deep		
		hülsta-MagicDive of wood in carcass version	hülsta-MagicDive of glass: with rear-side rim lacquering in carcass version	hülsta-MagicDive of wood in carcass version	hülsta-MagicDive of glass: with rear-side rim lacquering in carcass version
	as illustr. (L) v. versa (R)	<b>417811 L</b> <b>417812 R</b>	<b>417911 L</b> <b>417912 R</b>	<b>428111 L</b> <b>428112 R</b>	<b>429111 L</b> <b>429112 R</b>
	<b>USB charging station</b> for storage compartment under cover shelf: see next page. <b>Price gr.</b> I II	- -	- -	- -	- -
<p><b>6 Raster highboards with hülsta-MagicDive: floor units</b> 105.6 cm high (107.4 cm high incl. 1.8 cm high plinth adjusters), <b>52.0 cm deep</b></p> <p>A storage compartment incl. fabric-lined tray and inside LED lamp, operated by <b>Magic-Tronic</b>, opens/closes by an electric drive when the hülsta-MagicDive in the cover shelf is pushed lightly.</p> <p>This luminaire contains built-in LED lamps of the energy classes A+++ to A. The lamps cannot be changed in the luminaire. 230 V; 1.0 W</p> <p><b>Wall units: 6 Raster highboards with hülsta-MagicDive cannot be used as wall units.</b></p>	<p>with <b>hülsta-MagicDive</b> in cover shelf, optionally left (L) or right (R); 3 drawers each bottom left and right, 1 fixed panel each at top</p> <p>Usable sizes of storage compartment under cover shelf: Height: 9.4 cm Width: 60.8 cm; with integrated optional charging station: 48.4 cm Depth: 30.0 cm</p> <p>hülsta-MagicDive (electric)</p> <p>• = Position of Magic-Tronic sensor; in right side of right (R) unit</p>  <p>176.0 cm wide</p>		<p>with <b>hülsta-MagicDive</b> in cover shelf, optionally left (L) or right (R); 3 doors at bottom each with 1 fitted shelf, in the centre 3 drawers, 3 fixed panels at top</p> <p>Usable sizes of storage compartment under cover shelf: Height: 9.4 cm Width: 60.8 cm; with integrated optional charging station: 48.4 cm Depth: 30.0 cm</p> <p>hülsta-MagicDive (electric)</p> <p>• = Position of Magic-Tronic sensor; in right side of right (R) unit</p>  <p>211.2 cm wide</p>		
	52.0 cm deep		52.0 cm deep		
		hülsta-MagicDive of wood in carcass version	hülsta-MagicDive of glass: with rear-side rim lacquering in carcass version	hülsta-MagicDive of wood in carcass version	hülsta-MagicDive of glass: with rear-side rim lacquering in carcass version
	as illustr. (L) v. versa (R)	<b>617811 L</b> <b>617812 R</b>	<b>617911 L</b> <b>617912 R</b>	<b>628111 L</b> <b>628112 R</b>	<b>629111 L</b> <b>629112 R</b>
	<b>USB charging station</b> for storage compartment under cover shelf: see next page. <b>Price gr.</b> I II	- -	- -	- -	- -

## Metal substructures

Metal substructures see page 84.

## USB charging station

with two double USB connections (for mobiles, tablets, etc.); current strength per double USB connection: 1x max. 2.100 mA or 2x 1.050 mA. The USB charging station is only suitable for devices that are compatible with the above power level data. Connection cable between USB charging station and device is not supplied.

Can be fitted in the storage compartment under the cover shelf with hülsta-MagicDive in the side- and highboards.

The glass sliding-door of the MagicDive is rear-lacquered optionally in white, grey or silk grey.

**Please be sure to state the colour of the glass sliding-door in the order!**

The inside carcase of the MagicDive is in a matching matt lacquer colour for lacquer versions and high-gloss versions, and in matt grey lacquer for wood versions.

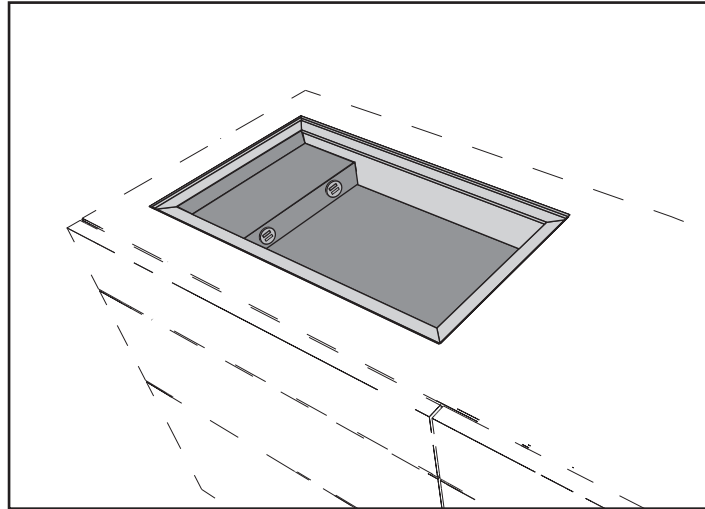

8531

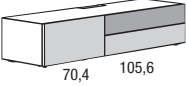
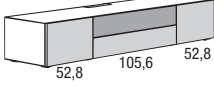
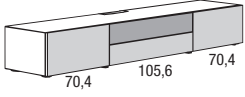
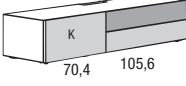
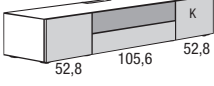
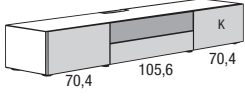
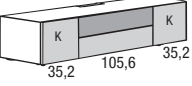
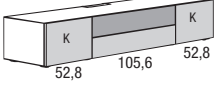
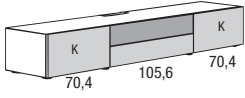

<p>1 drawer; 1 fabric-covered flap, 1 drawer</p>  <p>176.0 cm wide</p>	<p>1 drawer; 1 fabric-covered flap, 1 drawer; 1 drawer</p>  <p>211.2 cm wide</p>	<p>1 drawer; 1 fabric-covered flap, 1 drawer; 1 drawer</p>  <p>246.4 cm wide</p>
<p><b>2170751</b> <b>2170752</b></p> <p>-</p>	<p><b>221075</b></p> <p>-</p>	<p><b>224075</b></p> <p>-</p>
<p>1 flap; 1 fabric-covered flap, 1 drawer</p>  <p>176.0 cm wide</p>	<p>1 drawer; 1 fabric-covered flap, 1 drawer; 1 flap</p>  <p>211.2 cm wide</p>	<p>1 drawer; 1 fabric-covered flap, 1 drawer; 1 flap</p>  <p>246.4 cm wide</p>
<p><b>2171751</b> <b>2171752</b></p> <p>-</p>	<p><b>2211751</b> <b>2211752</b></p> <p>-</p>	<p><b>2241751</b> <b>2241752</b></p> <p>-</p>
<p>1 flap; 1 fabric-covered flap, 1 drawer; 1 flap</p>  <p>176.0 cm wide</p>	<p>1 flap; 1 fabric-covered flap, 1 drawer; 1 flap</p>  <p>211.2 cm wide</p>	<p>1 flap; 1 fabric-covered flap, 1 drawer; 1 flap</p>  <p>246.4 cm wide</p>
<p><b>217275</b></p> <p>-</p>	<p><b>221275</b></p> <p>-</p>	<p><b>224275</b></p> <p>-</p>

### 3 Raster media lowboards: Floor units

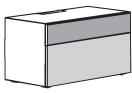
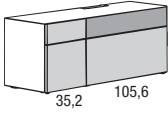
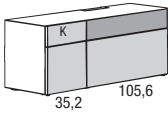
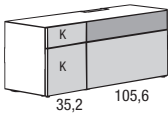
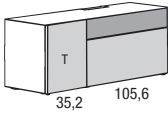
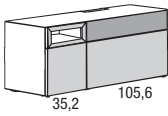
<p><b>3 Raster media lowboards: floor units</b> 52.8 cm high (54.6 cm high incl. 1.8 cm high plinth adjusters), <b>52.0 cm deep</b></p> <p>Cover shelf with cable cover in high-gloss chrome on rear edge</p> <p>incl. cable aperture at centre of rear wall behind flap per compartment</p> <p>Max. load: 40 kg</p>		1 fabric-covered flap, 1 drawer		105.6 cm wide				
	as illustr. v. versa		<b>310075</b>					
	<b>Price gr.</b> I II		- -					
			2 drawers; 1 fabric-covered flap, 1 drawer		140.8 cm wide			
			<b>3140751</b> <b>3140752</b>					
			- -					
			1 flap, 1 drawer; 1 fabric-covered flap, 1 drawer		140.8 cm wide			
	as illustr. v. versa		<b>3141751</b> <b>3141752</b>					
<b>Price gr.</b> I II		- -						
		2 flaps; 1 fabric-covered flap, 1 drawer		140.8 cm wide				
as illustr. v. versa		<b>3142751</b> <b>3142752</b>						
<b>Price gr.</b> I II		- -						
		1 door; 1 fabric-covered flap, 1 drawer		140.8 cm wide				
as illustr. v. versa		<b>3143751</b> <b>3143752</b>						
<b>Price gr.</b> I II		- -						
		1 open compartment, 1 drawer; 1 fabric-covered flap, 1 drawer		140.8 cm wide				
as illustr. v. versa		<b>3144751</b> <b>3144752</b>						
<b>Price gr.</b> I II		- -						

K = Flap  
T = Door

Please observe the space requirements given by the electrical dealer (heat build-up)!

### Metal substructures and glass cover shelves

Metal substructures and glass cover shelves see page 84.

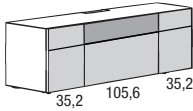
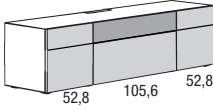
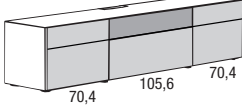
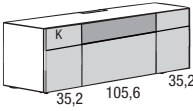
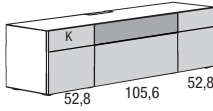
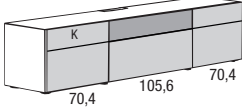
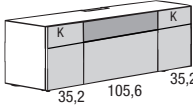
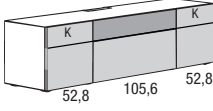
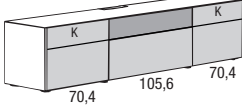
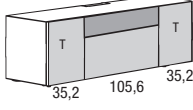
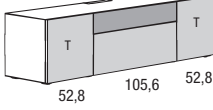
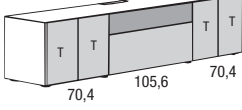
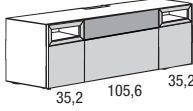
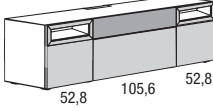
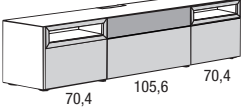
	<p>2 drawers; 1 fabric-covered flap, 1 drawer; 2 drawers</p>  <p>176.0 cm wide</p> <p><b>317075</b></p> <p>-</p> <p>-</p>	<p>2 drawers; 1 fabric-covered flap, 1 drawer; 2 drawers</p>  <p>211.2 cm wide</p> <p><b>321075</b></p> <p>-</p> <p>-</p>	<p>2 drawers; 1 fabric-covered flap, 1 drawer; 2 drawers</p>  <p>246.4 cm wide</p> <p><b>324075</b></p> <p>-</p> <p>-</p>
	<p>1 flap, 1 drawer; 1 fabric-covered flap, 1 drawer; 2 drawers</p>  <p>176.0 cm wide</p> <p><b>3171751</b> <b>3171752</b></p> <p>-</p> <p>-</p>	<p>1 flap, 1 drawer; 1 fabric-covered flap, 1 drawer; 2 drawers</p>  <p>211.2 cm wide</p> <p><b>3211751</b> <b>3211752</b></p> <p>-</p> <p>-</p>	<p>1 flap, 1 drawer; 1 fabric-covered flap, 1 drawer; 2 drawers</p>  <p>246.4 cm wide</p> <p><b>3241751</b> <b>3241752</b></p> <p>-</p> <p>-</p>
	<p>1 flap, 1 drawer; 1 fabric-covered flap, 1 drawer; 1 flap, 1 drawer</p>  <p>176.0 cm wide</p> <p><b>317275</b></p> <p>-</p> <p>-</p>	<p>1 flap, 1 drawer; 1 fabric-covered flap, 1 drawer; 1 flap, 1 drawer</p>  <p>211.2 cm wide</p> <p><b>321275</b></p> <p>-</p> <p>-</p>	<p>1 flap, 1 drawer; 1 fabric-covered flap, 1 drawer; 1 flap, 1 drawer</p>  <p>246.4 cm wide</p> <p><b>324275</b></p> <p>-</p> <p>-</p>
	<p>1 door; 1 fabric-covered flap, 1 drawer; 1 door</p>  <p>176.0 cm wide</p> <p><b>317375</b></p> <p>-</p> <p>-</p>	<p>1 door; 1 fabric-covered flap, 1 drawer; 1 door</p>  <p>211.2 cm wide</p> <p><b>321375</b></p> <p>-</p> <p>-</p>	<p>2 doors; 1 fabric-covered flap, 1 drawer; 2 doors</p>  <p>246.4 cm wide</p> <p><b>324375</b></p> <p>-</p> <p>-</p>
	<p>1 open compartment, 1 drawer; 1 fabric-covered flap, 1 drawer; 1 open compartment, 1 drawer</p>  <p>176.0 cm wide</p> <p><b>317475</b></p> <p>-</p> <p>-</p>	<p>1 open compartment, 1 drawer; 1 fabric-covered flap, 1 drawer; 1 open compartment, 1 drawer</p>  <p>211.2 cm wide</p> <p><b>321475</b></p> <p>-</p> <p>-</p>	<p>1 open compartment, 1 drawer; 1 fabric-covered flap, 1 drawer; 1 open compartment, 1 drawer</p>  <p>246.4 cm wide</p> <p><b>324475</b></p> <p>-</p> <p>-</p>

# Usable sizes for lowboards

## Sufficient ventilation for hi-fi (media) units

Please observe the space requirements given by the electrical dealer (heat build-up)!

## Usable sizes of 1 and 2 Raster lowboards

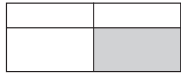

**Usable sizes behind 52 cm wide flap:**  
Height 1 / 2 Raster: 13.8 / 31.4 cm  
Width: 49 cm  
Depth 33 / 45 cm: 28.3 / 40.3 cm

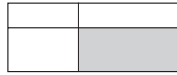

**Usable sizes behind 70 cm wide flap:**  
Height 1 / 2 Raster: 13.8 / 31.4 cm  
Width: 66.6 cm  
Depth 33 / 45 cm: 28.3 / 40.3 cm



**Usable sizes behind 105 cm wide flap:**  
Height 1 / 2 Raster: 13.8 / 31.4 cm  
Width: 97 cm  
Depth 33 / 45 cm: 28.3 / 40.3 cm

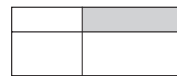

**Usable sizes in 70 cm wide, open compartment:**  
Height: 9.4 cm  
Width: 62.2 cm  
Depth 33 / 45 cm: 26.2 / 38.2 cm

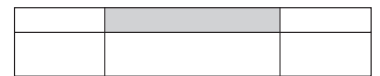

**Usable sizes in 105 cm wide, open compartment:**  
Height: 9.4 cm  
Width: 97.4 cm  
Depth 33 / 45 cm: 26.2 / 38.2 cm

## Usable sizes for 2 Raster media lowboards

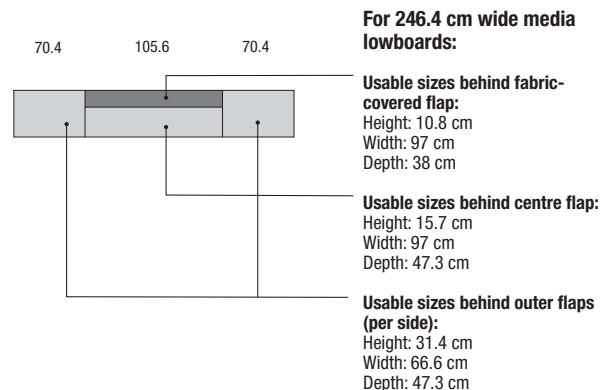
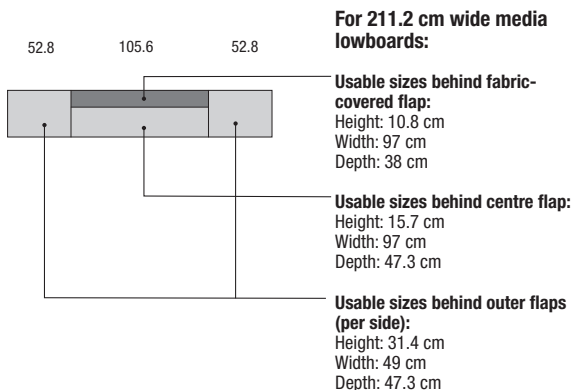
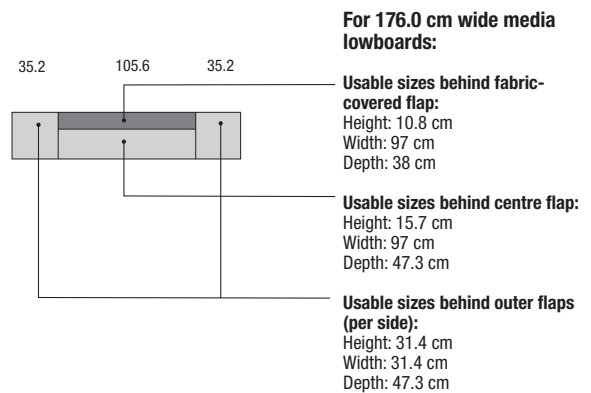
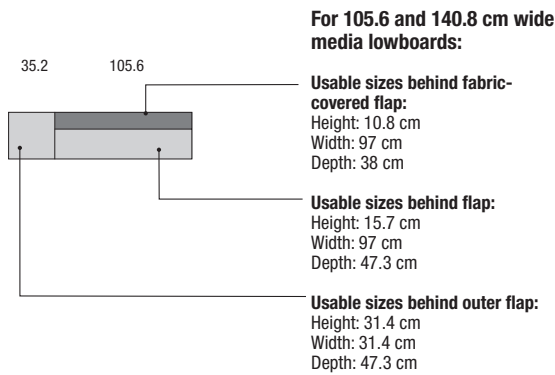



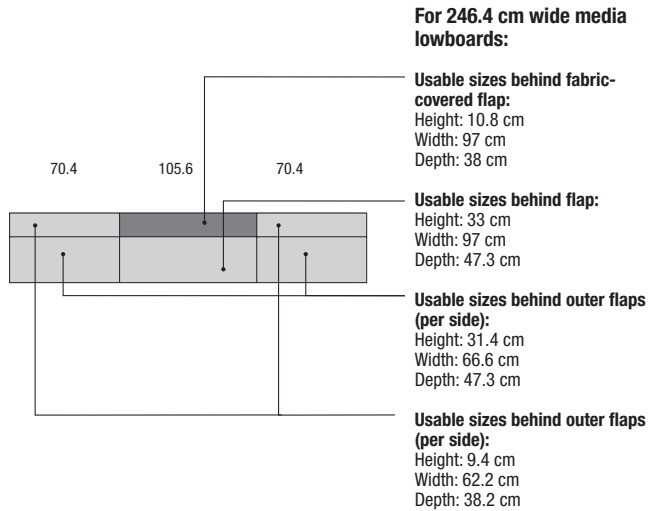
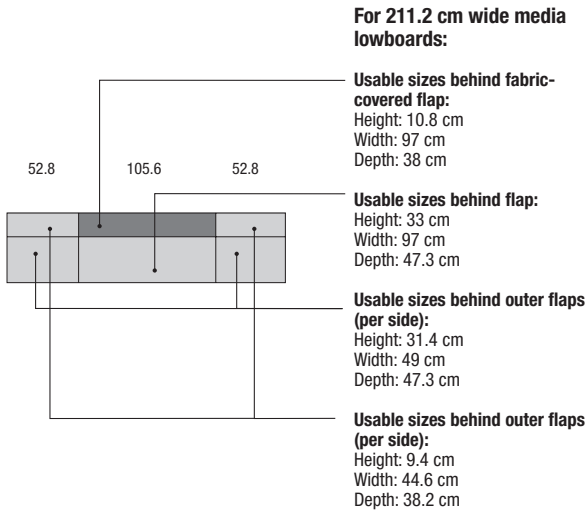
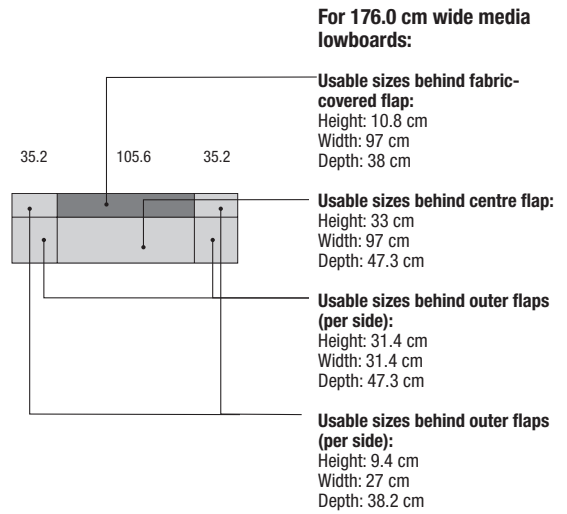
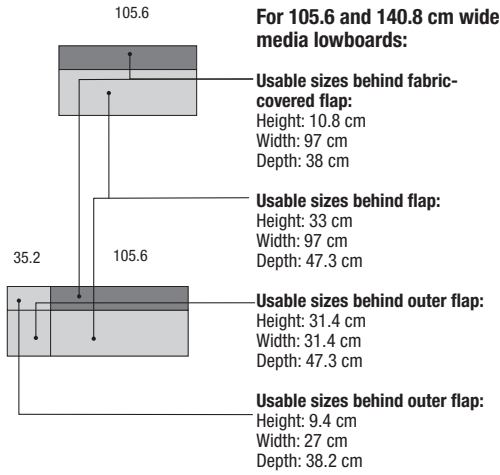

Usable sizes for 3 Raster media lowboards

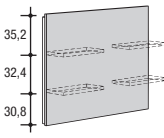
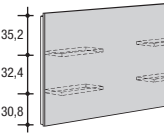
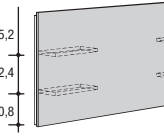
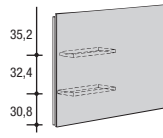

## 6 Raster media panels

<p><b>6 Raster media panels</b> 104.1 cm high; 9.6 cm thick incl. assembly space</p> <p>for fitting anywhere on walls using invisible special bracket</p>	broken lines = fixed position of optional media panel shelves (with LED lamps)			
	 140.8 cm wide	 176.0 cm wide	 211.2 cm wide	 246.4 cm wide
<b>Price gr.</b>	<b>6145</b>	<b>6175</b>	<b>6215</b>	<b>6245</b>
I	-	-	-	-
II	-	-	-	-

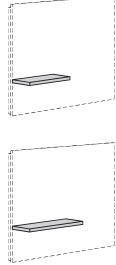
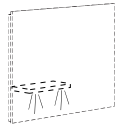
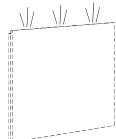
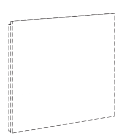
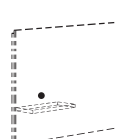
## Accessories for media panels





 <p><b>Media panel shelves</b> 23.4 cm deep; 2.9 cm thick</p> <p>Can only be fitted at fixed positions at the left and/or right and top and/or bottom of the media panels (see the sketches at top). Please state clearly in the order.</p> <p>Max. load: 15 kg</p>	<b>Price gr.</b>	52.8 cm wide		70.4 cm wide	
		I	55	75	-
II		-	-	-	-
This luminaire contains built-in LED lamps of the energy classes A++ to A. The lamps cannot be changed in the luminaire. 12 V			LED lamps incl. footswitch. A Magic-Tronic or remote control unit is possible for operation (against a surcharge).		
 <p><b>LED lamps for media panel shelves</b></p>	for 52.8 cm width		for 70.4 cm width		
	2.4 W		4.7 W		
I			512	812	-
II			-	-	-
 <p><b>Top LED lamps for media panels</b> for fitting at top behind media panels</p>	for 140.8 cm width	for 176.0 cm width	for 211.2 cm width	for 246.4 cm width	
	9.8 W	12.5 W	15.3 W	17.5 W	
I			914	917	921
II			-	-	-
 <p><b>Side LED lamps for media panels</b> for fitting left (L) and/or right (R) behind the media panels</p>	6.3 W				
	691 L 692 R				-
I			-		
II			-		
 <p><b>Cable aperture K3</b> Silver-coloured; Ø 7.2 cm (aperture 5.6 cm) It is possible to fit a cable aperture in the media panels above the lower media panel shelves (see sketch on the left). The cable aperture is made 37.5 cm from the lower rim and 35.2 cm from the left and/or right side of the media panel. Please state the exact position (left and/or right) clearly in the order!</p>	K3				
	-				-
I			-		
II			-		
<p>14.2 cm high 93.0 cm wide 40.0 cm deep</p>  <p><b>Top glass section for TV</b> Glass top, 1.0 cm thick, of clear glass, fitted on lowboards. Max. load: 50 kg</p>	1917				
	-				-
I			-		
II			-		

IR repeater sets

<p><b>IR repeater sets</b> Infrared signal transmission sets for operating media units behind wooden/lacquered fronts. You can operate all the units in one compartment with one set. The following applies:</p> <ul style="list-style-type: none"> <li>• One set must be used in each compartment. 2 transmitters can also be installed in large compartments in order to increase performance. In this case only one additional transmitter needs to be ordered.</li> <li>• The transmitter must be placed in the direct vicinity of the receiver eye of the media unit.</li> <li>• Transmittable IR frequency band 20 – 60 kHz</li> <li>• Up to 3 transmitters can be combined with one receiver.</li> </ul> <p>It is possible to use 3 transmitters via 1 receiver including Master box. This enables simultaneous operation of 3 different furniture compartments or in critical situations it allows fitting out one furniture compartment with several transmitters in order to increase the performance in this compartment or to operate 2 end units placed next to one another.</p> <p>The IR repeater set consists of:</p> <ul style="list-style-type: none"> <li>• in the case of <b>IR repeater set 1</b>: 1 receiver eye (Ø 3.0 cm) incl. standing bracket</li> <li>• in the case of <b>IR repeater set 2</b>: 1 receiver eye (Ø 3.0 cm)</li> <li>• 1 electrical transmitter</li> <li>• 1 plug EVG 12 V</li> <li>• Cable clips</li> </ul> <p><b>Standard fitting position of IR repeater set 2:</b></p> <ul style="list-style-type: none"> <li>• in media panels: 4.0 cm from the lower rim and 12.0 cm from the left outer side of the media panels</li> </ul> <p><b>Please note the details stated in the operating instructions!</b></p>	<p><b>IR repeater set 1</b> 1 receiver eye and 1 transmitter incl. standing bracket</p>	<p><b>IR repeater set 2</b> 1 receiver eye and 1 transmitter (always fitted at left of media panel)</p>
	<p><b>2001</b> -</p>	<p><b>2002</b> -</p>
	<p><b>Extra transmitter</b></p> <p><b>2003</b> -</p>	

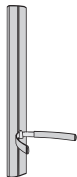
# Media accessories for lowboards

## Column system, flat screen supports

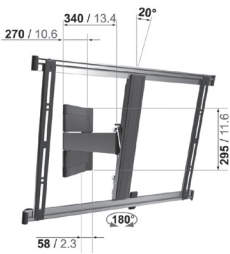
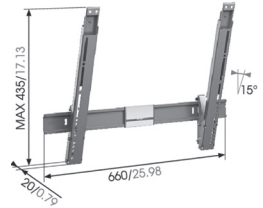
<p><b>Column system</b> consisting of a metal column (for fitting anywhere on wall) and of audio/DVD support(s), for fitting anywhere on column.</p> <p><b>Example of use:</b></p> 		<p><b>Columns</b> of metal; for fitting anywhere on walls above top rim of plinth slab; cables can be laid and hidden at any height; audio/DVD supports can be fitted anywhere on the column.</p> 		<p><b>Audio/DVD support</b> of metal; can be positioned at any height on the column and be adjusted to suit audio/DVD players of any size; with rubber padding at front to prevent units from slipping; max. load: 10 kg</p> 	
		36.8 cm high	64.1 cm high		
		<b>9201</b>	<b>9202</b>	<b>9203</b>	
		-	-	-	
<p><b>Flat screen support WTL6</b> The flat screen support can be adjusted 3-dimensionally. It is suitable for flat screens with a screen diagonal of 102-216 cm (40"-85"); max. load: 45 kg. Suitable for Curved TV's. Flat screen support compatible with VESA Norm standard: min.: 200 x 200 mm max.: 600 x 400 mm</p> 		<p><b>Flat screen support THIN 345, ideally adaptable</b> The flat screen support can be adjusted 3-dimensionally. It is suitable for flat screens with a screen diagonal of 81-140 cm (32"-55") and a maximum depth of 4.5 cm; max. load: 25 kg. Go to <a href="http://www.vogels.com">www.vogels.com</a> to check if your flat screen can be fitted on this flat screen support. Enter the name THIN 345. After a few steps you can see if your flat screen TV is compatible with the flat screen support. Not suitable for Curved TV's. Flat screen support compatible with VESA Norm standard: min.: 100 x 100 mm max.: 600 x 400 mm</p> 		<p><b>Flat screen support THIN 315</b> The flat screen support can be angled up to a max. 15°. It is suitable for flat screens with a screen diagonal of 102-165 cm (40"-65") and a maximum depth of 5.0 cm; max. load: 25 kg. Go to <a href="http://www.vogels.com">www.vogels.com</a> to check if your flat screen can be fitted on this flat screen support. Enter the name THIN 315. After a few steps you can see if your flat screen TV is compatible with the flat screen support. Not suitable for Curved TV's. Flat screen support compatible with VESA Norm standard: min.: 100 x 100 mm max.: 600 x 400 mm</p> 	
for fitting anywhere on walls	for fitting at fixed positions on media panels (see below; later assembly not possible; incl. cable aperture in support and wall panel)	for fitting anywhere on walls	for fitting at fixed positions on media panels (see below; later assembly not possible; incl. cable aperture in support and wall panel)	for fitting anywhere on walls	for fitting anywhere on media panels (a cable aperture K1 is supplied and can be fitted on site)
<b>9704</b>	<b>9705</b>	<b>9304</b>	<b>9305</b>	<b>9504</b>	<b>9505</b>
-	-	-	-	-	-

## Assembly positions of flat screen supports on media panels

Besides being able to mount the flat screen support anywhere on a wall, it is also possible to mount it in front of media panels in the range. For reasons of statics and construction, only the assembly positions shown below are possible for the **flat screen supports types 9705 and 9305**, other positions must not be used. Please state clearly in your order at which position the flat screen support is to be mounted, the media panels are then provided with mounting holes accordingly. Later assembly is not possible. The **flat screen support type 9505** can be mounted at any position - even at a later date. Height position: centrally in wall panel.

### Possible width positions of flat screen supports on media panels

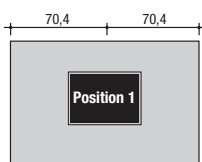

**In sketch 1:**  
The centre of the flat screen support is 70.4 cm from the left and right side of the media panel.

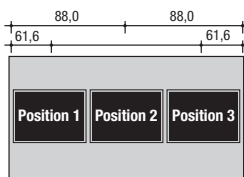

**In sketch 2:**  
The centre of the flat screen support in position 1 (or position 3) is 61.6 cm from the left (or right) side of the media panel. The centre of the flat screen support in position 2 is 88.0 cm from the left and right side of the media panel.

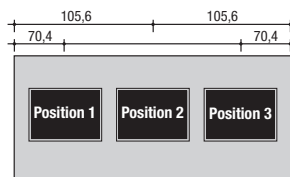

**In sketch 3:**  
The centre of the flat screen support in position 1 (or position 3) is 70.4 cm from the left (or right) side of the media panel. The centre of the flat screen support in position 2 is 105.6 cm from the left and right side of the media panel.

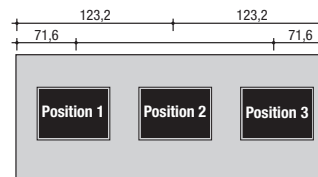

**In sketch 4:**  
The centre of the flat screen support in position 1 (or position 3) is 71.6 cm from the left (or right) side of the media panel. The centre of the flat screen support in position 2 is 123.2 cm from the left and right side of the media panel.

**Note on measurements in sketches:**  
The size scale above the sketches is not true to scale. The sizes are always based on the centre of the flatscreen TV support in the given fitted position.





## 2 Raster wall units

Accessories: see pages 82-84.  
Lamps: see pages 86-87.

**2 Raster wall units**  
35.2 cm high,  
**33.0 cm deep**  
for fitting anywhere on walls

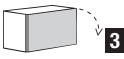
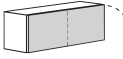
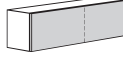
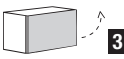
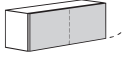
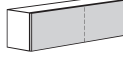
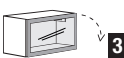
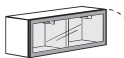
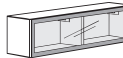
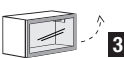
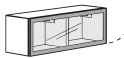
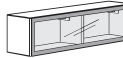
	1 flap	1 flap	1 flap	
	 70.4 cm wide	 105.6 cm wide	 140.8 cm wide	
	Flap hinge at bottom	Flap hinge at bottom	Flap hinge at bottom	
	33.0 cm deep	33.0 cm deep	33.0 cm deep	
<b>Price gr.</b>	<b>2718</b>	<b>2108</b>	<b>2148</b>	
<b>I</b>	-	-	-	
<b>II</b>	-	-	-	
	1 flap	1 flap	1 flap	
	 70.4 cm wide	 105.6 cm wide	 140.8 cm wide	
	Flap hinge at top	Flap hinge at top	Flap hinge at top	
	33.0 cm deep	33.0 cm deep	33.0 cm deep	
<b>Price gr.</b>	<b>2719</b>	<b>2109</b>	<b>2149</b>	
<b>I</b>	-	-	-	
<b>II</b>	-	-	-	
	1 glass flap	1 glass flap	1 glass flap	
	 70.4 cm wide	 105.6 cm wide	 140.8 cm wide	
	Flap hinge at bottom	Flap hinge at bottom	Flap hinge at bottom	
	33.0 cm deep	33.0 cm deep	33.0 cm deep	
<b>Price gr.</b>	<b>2714</b>	<b>2104</b>	<b>2144</b>	
<b>I</b>	-	-	-	
<b>II</b>	-	-	-	
	1 glass flap	1 glass flap	1 glass flap	
	 70.4 cm wide	 105.6 cm wide	 140.8 cm wide	
	Flap hinge at top	Flap hinge at top	Flap hinge at top	
	33.0 cm deep	33.0 cm deep	33.0 cm deep	
<b>Price gr.</b>	<b>2715</b>	<b>2105</b>	<b>2145</b>	
<b>I</b>	-	-	-	
<b>II</b>	-	-	-	

Max. load of wall units:  
Max. load 15 kg per metre:  
105.6 cm width: 15.0 kg  
140.8 cm width: 20.0 kg  
176.0 cm width: 25.0 kg  
211.2 cm width: 30.0 kg

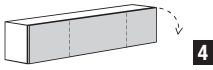
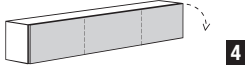
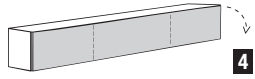
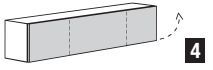
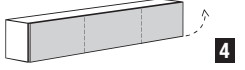
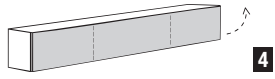
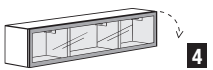
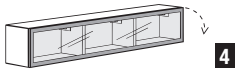
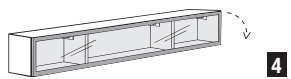
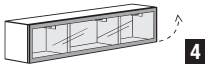
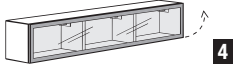
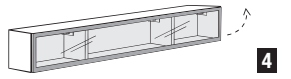
<p>1 flap</p>  <p>176.0 cm wide</p>	<p>1 flap</p>  <p>211.2 cm wide</p>	<p>1 flap</p>  <p>246.4 cm wide</p>
<p>Flap hinge at bottom</p>	<p>Flap hinge at bottom</p>	<p>Flap hinge at bottom</p>
<p>33.0 cm deep</p>	<p>33.0 cm deep</p>	<p>33.0 cm deep</p>
<p><b>2178</b></p> <p>-</p>	<p><b>2218</b></p> <p>-</p>	<p><b>2248</b></p> <p>-</p>
<p>1 flap</p>  <p>176.0 cm wide</p>	<p>1 flap</p>  <p>211.2 cm wide</p>	<p>1 flap</p>  <p>246.4 cm wide</p>
<p>Flap hinge at top</p>	<p>Flap hinge at top</p>	<p>Flap hinge at top</p>
<p>33.0 cm deep</p>	<p>33.0 cm deep</p>	<p>33.0 cm deep</p>
<p><b>2179</b></p> <p>-</p>	<p><b>2219</b></p> <p>-</p>	<p><b>2249</b></p> <p>-</p>
<p>1 glass flap</p>  <p>176.0 cm wide</p>	<p>1 glass flap</p>  <p>211.2 cm wide</p>	<p>1 glass flap</p>  <p>246.4 cm wide</p>
<p>Flap hinge at bottom</p>	<p>Flap hinge at bottom</p>	<p>Flap hinge at bottom</p>
<p>33.0 cm deep</p>	<p>33.0 cm deep</p>	<p>33.0 cm deep</p>
<p><b>2174</b></p> <p>-</p>	<p><b>2214</b></p> <p>-</p>	<p><b>2244</b></p> <p>-</p>
<p>1 glass flap</p>  <p>176.0 cm wide</p>	<p>1 glass flap</p>  <p>211.2 cm wide</p>	<p>1 glass flap</p>  <p>246.4 cm wide</p>
<p>Flap hinge at top</p>	<p>Flap hinge at top</p>	<p>Flap hinge at top</p>
<p>33.0 cm deep</p>	<p>33.0 cm deep</p>	<p>33.0 cm deep</p>
<p><b>2175</b></p> <p>-</p>	<p><b>2215</b></p> <p>-</p>	<p><b>2245</b></p> <p>-</p>

# Planning and possible arrangements for free planning

## Planning and possible arrangements for free planning with floor units

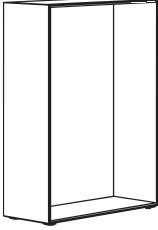
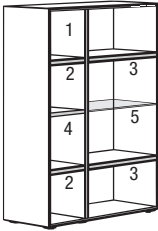
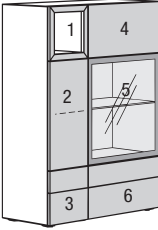
Planning step 1:	Components		Type no.
<p>Choosing the carcass unit consisting of: carcass - on 1.8 cm high plinth adjusters (from 105.6 cm width also optionally on a 12.8 cm high metal substructure) or with a wall bracket - and rear wall; also with optional extra top cover shelf.</p> 		<p><b>1 Carcass unit,</b> 8 Raster high (142.6 cm incl. 1.8 cm high plinth adjusters), 105.6 cm wide, 42.3 cm deep</p>	<p><b>81040</b></p>
<p><b>Step 2:</b></p> <p>Choosing the interior fittings (partitions, constructional shelves, fitted shelves, accessories)</p> <p><b>Note:</b> Partitions, constructional and fitted shelves can be fitted anywhere within the Raster system. Partitions must be included from 140.8 cm width, though no partitions can be fitted on glass shelves (please see sketch raster). If different fronts like drawers, flap units or doors are stacked on top of one another, constructional shelves must be fitted in between. If several drawers are fitted on top of one another, it is not necessary to fit a constructional shelf between the drawers. <b>Please also observe the additional notes on wall units on the following page.</b></p> 	<p>1</p> <p>2</p> <p>3</p> <p>4</p> <p>5</p>	<p><b>1 Centre partition for carcass unit,</b> for 8 Raster height and 42.3 cm depth</p> <p><b>2 Constructional shelves for carcass unit,</b> for 35.2 cm width and 42.3 cm depth</p> <p><b>2 Constructional shelves for carcass unit,</b> for 70.4 cm width and 42.3 cm depth</p> <p><b>1 Fitted shelf for carcass unit,</b> for 35.2 cm width and 42.3 cm depth</p> <p><b>1 Fitted glass shelf for carcass unit,</b> for 70.4 cm width and 42.3 cm depth</p>	<p><b>840</b></p> <p><b>634</b></p> <p><b>674</b></p> <p><b>134</b></p> <p><b>374</b></p>
<p><b>Step 3:</b></p> <p>Choosing the fronts (drawers, flaps, doors and open compartments for carcass units)</p> <p><b>Note:</b> Drawer fronts and flaps must be fitted between constructional shelves and partitions/carcass sides. Each compartment must be fitted with a front or an open compartment for carcass units.</p> 	<p>1</p> <p>2</p> <p>3</p> <p>4</p> <p>5</p> <p>6</p>	<p><b>1 Open compartment for carcass unit,</b> for 2 Raster height, 35.2 cm width and 42.3 cm depth</p> <p><b>1 Door for carcass unit,</b> 4 Raster high for 35.2 cm width</p> <p><b>2 drawers for carcass unit,</b> 2 Raster high for 35.2 cm width and 42.3 cm depth</p> <p><b>1 Drawer for carcass unit,</b> 2 Raster high for 70.4 cm width and 42.3 cm depth</p> <p><b>1 Glass door for carcass unit,</b> 4 Raster high for 70.4 cm width</p> <p><b>2 drawers for carcass unit,</b> 2 Raster high for 70.4 cm width and 42.3 cm depth</p>	<p><b>2035</b></p> <p><b>40311 L</b></p> <p><b>2301</b></p> <p><b>2702</b></p> <p><b>40742 R</b></p> <p><b>2701</b></p>



## Planning and possible arrangements for free planning with wall units, wall low-, side- and highboards

Fixed partitions are necessary for wall units, wall low-, side- and highboards for reasons of safety. Please also observe the notes on maximum loads and the notes on the quality of walls in the "Wall composition" chapter.

105.6 cm wide

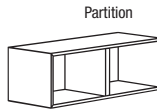

**1 and 2 Raster wall units/lowboards in 105.6 cm width**  
1 partition is essential.

105.6 cm wide

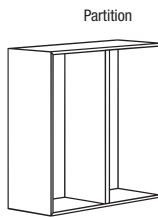

**4 - 12 Raster wall units in 105.6 cm width**  
1 partition is essential.

140.8 cm wide  
and  
158.4 cm wide

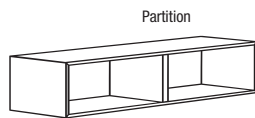

**1 and 2 Raster lowboards in 140.8 or 158.4 cm width**  
At least 1 partition is essential.

176.0 cm wide

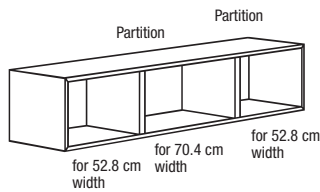

**Note:**  
The partitions must be fitted at least 52.8 cm from the side sections. They can also be fitted at a greater distance than 52.8 cm from the side sections.

211.2 cm wide

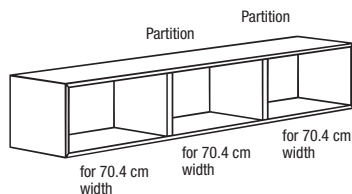

**1 and 2 Raster lowboards in 176.0, 211.2 and 246.4 cm width**  
At least 2 partitions are essential.

246.4 cm wide

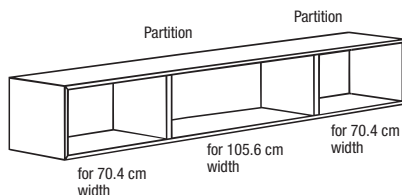





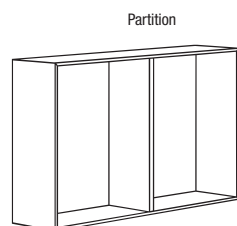









**Note:**  
The partitions must be fitted at least 70.4 cm from the side sections. They can also be fitted at a greater distance than 70.4 cm from the side sections.

176.0 cm wide  
and  
211.2 cm wide

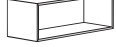

**4 Raster sideboards and 6 Raster highboards in 176.0 and 211.2 cm width**  
At least 1 partition is essential.

# Carcase units: Floor units or as wall units

<p><b>1 Raster carcass units</b> 17.6 cm high (19.4 cm high incl. 1.8 cm high plinth adjusters)</p> <p><b>2 Raster carcass units</b> 35.2 cm high (37.0 cm high incl. 1.8 cm high plinth adjusters)</p> <p><b>3 Raster carcass units</b> 52.8 cm high (54.6 cm high incl. 1.8 cm high plinth adjusters)</p> <p><b>Carcass unit depth:</b> for all widths: 30.3 and 42.3 cm; from 105.6 cm width extra 49.3 cm</p> <p>Carcass units consisting of carcass and rear wall</p> <p>Partitions, constructional and fitted shelves can be fitted anywhere within the Raster system.</p>	<b>1 Raster carcass units</b>		<b>49.3 cm deep 1 Raster carcass units cannot be fitted as wall units!</b>									
			 35.2 cm wide		 52.8 cm wide		 70.4 cm wide		 105.6 cm wide			
			30.3 cm deep	42.3 cm deep	30.3 cm deep	42.3 cm deep	30.3 cm deep	42.3 cm deep	30.3 cm deep	42.3 cm deep	49.3 cm deep	
			<b>13530</b>	<b>13540</b>	<b>15230</b>	<b>15240</b>	<b>17030</b>	<b>17040</b>	<b>11030</b>	<b>11040</b>	<b>11047</b>	
	<b>Price gr.</b>		-	-	-	-	-	-	-	-	-	
	<b>I</b>		-	-	-	-	-	-	-	-	-	
	<b>II</b>		-	-	-	-	-	-	-	-	-	
	<b>2 Raster carcass units</b>		<b>49.3 cm deep 2 Raster carcass units cannot be fitted as wall units!</b>									
			 17.6 cm wide		 35.2 cm wide		 52.8 cm wide		 70.4 cm wide		 105.6 cm wide	
			30.3 cm deep	42.3 cm deep	30.3 cm deep	42.3 cm deep	30.3 cm deep	42.3 cm deep	30.3 cm deep	42.3 cm deep	49.3 cm deep	
		<b>21830</b>	<b>21840</b>	<b>23530</b>	<b>23540</b>	<b>25230</b>	<b>25240</b>	<b>27030</b>	<b>27040</b>	<b>21030</b>	<b>21040</b>	<b>21047</b>
<b>Price gr.</b>		-	-	-	-	-	-	-	-	-	-	
<b>I</b>		-	-	-	-	-	-	-	-	-	-	
<b>II</b>		-	-	-	-	-	-	-	-	-	-	
<b>3 Raster carcass units</b>		 17.6 cm wide		 35.2 cm wide		 52.8 cm wide		 70.4 cm wide		 105.6 cm wide		
		30.3 cm deep	42.3 cm deep	30.3 cm deep	42.3 cm deep	30.3 cm deep	42.3 cm deep	30.3 cm deep	42.3 cm deep	49.3 cm deep		
		<b>31830</b>	<b>31840</b>	<b>33530</b>	<b>33540</b>	<b>35230</b>	<b>35240</b>	<b>37030</b>	<b>37040</b>	<b>31030</b>	<b>31040</b>	<b>31047</b>
<b>Price gr.</b>		-	-	-	-	-	-	-	-	-	-	
<b>I</b>		-	-	-	-	-	-	-	-	-	-	
<b>II</b>		-	-	-	-	-	-	-	-	-	-	

When used as wall units or stacked units:  
Max. load 15 kg per metre:  
17.6 cm width: 5.0 kg  
35.2 cm width: 5.0 kg  
52.8 cm width: 7.5 kg  
70.4 cm width: 10.0 kg;  
from 105.6 cm width:  
Max. load per unit: 40 kg

## Wall bracket

<p>If units are to be included as wall units, a wall bracket must be ordered. If units are stacked on top of one another, a wall bracket must only be ordered for the stacked unit(s) if the stacked unit is wider than the floor unit or if the units are stacked in an off-set position.</p>	for 17.6 cm width	for 35.2 cm width	for 52.8 cm width	for 70.4 cm width	for 105.6 cm width
	<b>4170</b>	<b>4352</b>	<b>4528</b>	<b>4704</b>	<b>4105</b>
	-	-	-	-	-

## Metal substructures and glass cover shelves

Metal substructures and glass cover shelves see page 84.

**Notes on delivery:**  
Please see here the information on range introduction pages.

1  
2

**Assembly notes for wall units:**  
Please be sure to note here the information and notes in the "Wall composition" chapter!

3  
4











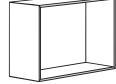

49.3 cm deep 1 Raster carcass units cannot be fitted as wall units!															
140.8 cm wide			158.4 cm wide			176.0 cm wide			211.2 cm wide			246.4 cm wide			
30.3 cm deep	42.3 cm deep	49.3 cm deep	30.3 cm deep	42.3 cm deep	49.3 cm deep	30.3 cm deep	42.3 cm deep	49.3 cm deep	30.3 cm deep	42.3 cm deep	49.3 cm deep	30.3 cm deep	42.3 cm deep	49.3 cm deep	
<b>11430</b>	<b>11440</b>	<b>11447</b>	<b>11530</b>	<b>11540</b>	<b>11547</b>	<b>17630</b>	<b>17640</b>	<b>17647</b>	<b>12130</b>	<b>12140</b>	<b>12147</b>	<b>12430</b>	<b>12440</b>	<b>12447</b>	
-	-	-	-	-	-	-	-	-	-	-	-	-	-	-	

49.3 cm deep 2 Raster carcass units cannot be fitted as wall units!															
140.8 cm wide			158.4 cm wide			176.0 cm wide			211.2 cm wide			246.4 cm wide			
30.3 cm deep	42.3 cm deep	49.3 cm deep	30.3 cm deep	42.3 cm deep	49.3 cm deep	30.3 cm deep	42.3 cm deep	49.3 cm deep	30.3 cm deep	42.3 cm deep	49.3 cm deep	30.3 cm deep	42.3 cm deep	49.3 cm deep	
<b>21430</b>	<b>21440</b>	<b>21447</b>	<b>21530</b>	<b>21540</b>	<b>21547</b>	<b>27630</b>	<b>27640</b>	<b>27647</b>	<b>22130</b>	<b>22140</b>	<b>22147</b>	<b>22430</b>	<b>22440</b>	<b>22447</b>	
-	-	-	-	-	-	-	-	-	-	-	-	-	-	-	

140.8 cm wide			158.4 cm wide			176.0 cm wide			211.2 cm wide			246.4 cm wide		
30.3 cm deep	42.3 cm deep	49.3 cm deep	30.3 cm deep	42.3 cm deep	49.3 cm deep	30.3 cm deep	42.3 cm deep	49.3 cm deep	30.3 cm deep	42.3 cm deep	49.3 cm deep	30.3 cm deep	42.3 cm deep	49.3 cm deep
<b>31430</b>	<b>31440</b>	<b>31447</b>	<b>31530</b>	<b>31540</b>	<b>31547</b>	<b>37630</b>	<b>37640</b>	<b>37647</b>	<b>32130</b>	<b>32140</b>	<b>32147</b>	<b>32430</b>	<b>32440</b>	<b>32447</b>
-	-	-	-	-	-	-	-	-	-	-	-	-	-	-

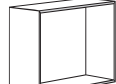
for 140.8 cm width	for 158.4 cm width	for 176.0 cm width	for 211.2 cm width	for 246.4 cm width
<b>4140</b>	<b>4150</b>	<b>4176</b>	<b>4211</b>	<b>4246</b>
-	-	-	-	-

# Carcase units: Floor units or as wall units

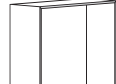
<p><b>4 Raster carcass units</b> 70.4 cm high (72.2 cm high incl. 1.8 cm high plinth adjusters)</p> <p><b>5 Raster carcass units</b> 88.0 cm high (89.8 cm high incl. 1.8 cm high plinth adjusters)</p> <p><b>6 Raster carcass units</b> 105.6 cm high (107.4 cm high incl. 1.8 cm high plinth adjusters)</p> <p><b>Carcass unit depth:</b> for all widths: 30.3 and 42.3 cm; from 105.6 cm width extra 49.3 cm</p> <p>Carcass units consisting of carcass and rear wall</p> <p>Partitions, constructional and fitted shelves can be fitted anywhere within the Raster system.</p>	<b>4 Raster carcass units</b>											
												
	17.6 cm wide		35.2 cm wide		52.8 cm wide		70.4 cm wide		105.6 cm wide			
		30.3 cm deep	42.3 cm deep	30.3 cm deep	42.3 cm deep	30.3 cm deep	42.3 cm deep	30.3 cm deep	42.3 cm deep	30.3 cm deep	42.3 cm deep	49.3 cm deep
	<b>Price gr.</b>	<b>41830</b>	<b>41840</b>	<b>43530</b>	<b>43540</b>	<b>45230</b>	<b>45240</b>	<b>47030</b>	<b>47040</b>	<b>41030</b>	<b>41040</b>	<b>41047</b>
	<b>I</b>	-	-	-	-	-	-	-	-	-	-	-
	<b>II</b>	-	-	-	-	-	-	-	-	-	-	-
	<b>5 Raster carcass units</b>											
	<b>NEW</b>											
												
	17.6 cm wide		35.2 cm wide		52.8 cm wide		70.4 cm wide		105.6 cm wide			
		30.3 cm deep	42.3 cm deep	30.3 cm deep	42.3 cm deep	30.3 cm deep	42.3 cm deep	30.3 cm deep	42.3 cm deep	30.3 cm deep	42.3 cm deep	49.3 cm deep
<b>Price gr.</b>	<b>51830</b>	<b>51840</b>	<b>53530</b>	<b>53540</b>	<b>55230</b>	<b>55240</b>	<b>57030</b>	<b>57040</b>	<b>51030</b>	<b>51040</b>	<b>51047</b>	
<b>I</b>	-	-	-	-	-	-	-	-	-	-	-	
<b>II</b>	-	-	-	-	-	-	-	-	-	-	-	
<b>6 Raster carcass units</b>												
												
17.6 cm wide		35.2 cm wide		52.8 cm wide		70.4 cm wide		105.6 cm wide				
	30.3 cm deep	42.3 cm deep	30.3 cm deep	42.3 cm deep	30.3 cm deep	42.3 cm deep	30.3 cm deep	42.3 cm deep	30.3 cm deep	42.3 cm deep	49.3 cm deep	
<b>Price gr.</b>	<b>61830</b>	<b>61840</b>	<b>63530</b>	<b>63540</b>	<b>65230</b>	<b>65240</b>	<b>67030</b>	<b>67040</b>	<b>61030</b>	<b>61040</b>	<b>61047</b>	
<b>I</b>	-	-	-	-	-	-	-	-	-	-	-	
<b>II</b>	-	-	-	-	-	-	-	-	-	-	-	

When used as wall units or stacked units:  
Max. load 15 kg per metre:  
17.6 cm width: 5.0 kg  
35.2 cm width: 5.0 kg  
52.8 cm width: 7.5 kg  
70.4 cm width: 10.0 kg;  
from 105.6 cm width:  
Max. load per unit: 40 kg

## Wall bracket







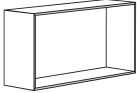
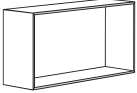
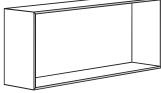

<p>If units are to be included as wall units, a wall bracket must be ordered. If units are stacked on top of one another, a wall bracket must only be ordered for the stacked unit(s) if the stacked unit is wider than the floor unit or if the units are stacked in an off-set position.</p>	for 17.6 cm width	for 35.2 cm width	for 52.8 cm width	for 70.4 cm width	for 105.6 cm width	
	<b>4170</b>	<b>4352</b>	<b>4528</b>	<b>4704</b>	<b>4105</b>	
	-	-	-	-	-	

## Metal substructures and glass cover shelves

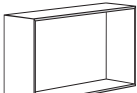
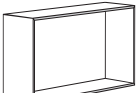
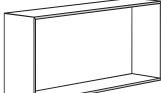
Metal substructures and glass cover shelves see page 84.

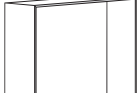
**Notes on delivery:**  
Please see here the information on range introduction pages.

**Assembly notes for wall units:**  
Please be sure to note here the information and notes in the "Wall composition" chapter!











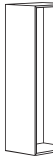

 140.8 cm wide			 158.4 cm wide			 176.0 cm wide			 211.2 cm wide			 246.4 cm wide		
30.3 cm deep	42.3 cm deep	49.3 cm deep	30.3 cm deep	42.3 cm deep	49.3 cm deep	30.3 cm deep	42.3 cm deep	49.3 cm deep	30.3 cm deep	42.3 cm deep	49.3 cm deep	30.3 cm deep	42.3 cm deep	49.3 cm deep
<b>41430</b>	<b>41440</b>	<b>41447</b>	<b>41530</b>	<b>41540</b>	<b>41547</b>	<b>47630</b>	<b>47640</b>	<b>47647</b>	<b>42130</b>	<b>42140</b>	<b>42147</b>	<b>42430</b>	<b>42440</b>	<b>42447</b>
-	-	-	-	-	-	-	-	-	-	-	-	-	-	-
 140.8 cm wide			 158.4 cm wide			 176.0 cm wide			 211.2 cm wide			 246.4 cm wide		
30.3 cm deep	42.3 cm deep	49.3 cm deep	30.3 cm deep	42.3 cm deep	49.3 cm deep	30.3 cm deep	42.3 cm deep	49.3 cm deep	30.3 cm deep	42.3 cm deep	49.3 cm deep	30.3 cm deep	42.3 cm deep	49.3 cm deep
<b>51430</b>	<b>51440</b>	<b>51447</b>	<b>51530</b>	<b>51540</b>	<b>51547</b>	<b>57630</b>	<b>57640</b>	<b>57647</b>	<b>52130</b>	<b>52140</b>	<b>52147</b>	<b>52430</b>	<b>52440</b>	<b>52447</b>
-	-	-	-	-	-	-	-	-	-	-	-	-	-	-
 140.8 cm wide			 158.4 cm wide			 176.0 cm wide			 211.2 cm wide			 246.4 cm wide		
30.3 cm deep	42.3 cm deep	49.3 cm deep	30.3 cm deep	42.3 cm deep	49.3 cm deep	30.3 cm deep	42.3 cm deep	49.3 cm deep	30.3 cm deep	42.3 cm deep	49.3 cm deep	30.3 cm deep	42.3 cm deep	49.3 cm deep
<b>61430</b>	<b>61440</b>	<b>61447</b>	<b>61530</b>	<b>61540</b>	<b>61547</b>	<b>61730</b>	<b>61740</b>	<b>61747</b>	<b>62130</b>	<b>62140</b>	<b>62147</b>	<b>62430</b>	<b>62440</b>	<b>62447</b>
-	-	-	-	-	-	-	-	-	-	-	-	-	-	-

for 140.8 cm width	for 158.4 cm width	for 176.0 cm width	for 211.2 cm width	for 246.4 cm width
<b>4140</b>	<b>4150</b>	<b>4176</b>	<b>4211</b>	<b>4246</b>
-	-	-	-	-

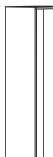
# Carcase units: Floor units or as wall units

**Notes on delivery:**  
Please see here the information on range introduction pages.

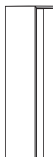
1
2

<p><b>8 Raster carcass units</b> 140.8 cm high (142.6 cm high incl. 1.8 cm high plinth adjusters)</p> <p><b>10 Raster carcass units</b> 176.0 cm high (177.8 cm high incl. 1.8 cm high plinth adjusters)</p> <p><b>12 Raster carcass units</b> 211.2 cm high (213.0 cm high incl. 1.8 cm high plinth adjusters)</p> <p><b>Carcass unit depth:</b> for all widths: 30.3 cm and 42.3 cm</p> <p>Carcass units consisting of carcass and rear wall</p> <p>Partitions, constructional and fitted shelves can be fitted anywhere within the Raster system.</p>	<b>8 Raster carcass units</b>										
											
	17.6 cm wide		35.2 cm wide		52.8 cm wide		70.4 cm wide		105.6 cm wide		
		30.3 cm deep	42.3 cm deep	30.3 cm deep	42.3 cm deep	30.3 cm deep	42.3 cm deep	30.3 cm deep	42.3 cm deep	30.3 cm deep	42.3 cm deep
	<b>Price gr.</b>	<b>81830</b>	<b>81840</b>	<b>83530</b>	<b>83540</b>	<b>85230</b>	<b>85240</b>	<b>87030</b>	<b>87040</b>	<b>81030</b>	<b>81040</b>
	<b>I</b>	-	-	-	-	-	-	-	-	-	-
	<b>II</b>	-	-	-	-	-	-	-	-	-	-
	<b>10 Raster carcass units</b>										
											
	17.6 cm wide		35.2 cm wide		52.8 cm wide		70.4 cm wide		105.6 cm wide		
	30.3 cm deep	42.3 cm deep	30.3 cm deep	42.3 cm deep	30.3 cm deep	42.3 cm deep	30.3 cm deep	42.3 cm deep	30.3 cm deep	42.3 cm deep	
<b>Price gr.</b>	<b>101830</b>	<b>101840</b>	<b>103530</b>	<b>103540</b>	<b>105230</b>	<b>105240</b>	<b>107030</b>	<b>107040</b>	<b>101030</b>	<b>101040</b>	
<b>I</b>	-	-	-	-	-	-	-	-	-	-	
<b>II</b>	-	-	-	-	-	-	-	-	-	-	
<b>12 Raster carcass units</b>											
											
17.6 cm wide		35.2 cm wide		52.8 cm wide		70.4 cm wide		105.6 cm wide			
	30.3 cm deep	42.3 cm deep	30.3 cm deep	42.3 cm deep	30.3 cm deep	42.3 cm deep	30.3 cm deep	42.3 cm deep	30.3 cm deep	42.3 cm deep	
<b>Price gr.</b>	<b>121830</b>	<b>121840</b>	<b>123530</b>	<b>123540</b>	<b>125230</b>	<b>125240</b>	<b>127030</b>	<b>127040</b>	<b>121030</b>	<b>121040</b>	
<b>I</b>	-	-	-	-	-	-	-	-	-	-	
<b>II</b>	-	-	-	-	-	-	-	-	-	-	

When used as wall units or stacked units:  
Max. load per unit: 40 kg

## Wall bracket





<p>If units are to be included as wall units, a wall bracket must be ordered. If units are stacked on top of one another, a wall bracket must only be ordered for the stacked unit(s) if the stacked unit is wider than the floor unit or if the units are stacked in an off-set position.</p>	for 17.6 cm width	for 35.2 cm width	for 52.8 cm width	for 70.4 cm width	for 105.6 cm width
	<b>4170</b>	<b>4352</b>	<b>4528</b>	<b>4704</b>	<b>4105</b>
	-	-	-	-	-

## Metal substructures and glass cover shelves

Metal substructures and glass cover shelves see page 84.

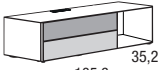
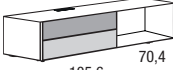
# Carcase units for media lowboards: Floor units

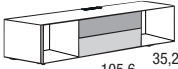
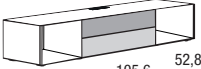
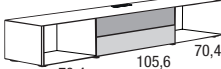
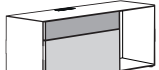
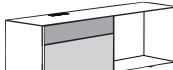
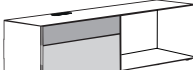
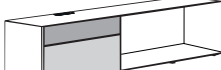
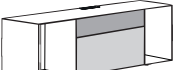
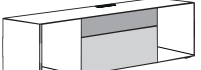
NEO

<p><b>2 and 3 Raster carcasses for media lowboards: floor units</b> 35.2 or 52.8 cm high (37.0 or 54.6 cm high incl. 1.8 cm high plinth adjusters), <b>52.0 cm deep</b></p> <p>All carcass units incl. 1 fabric-covered flap and 1 drawer</p> <p>Cover shelf with cable cover in high-gloss chrome on rear edge</p> <p>Incl. cable aperture at centre of rear wall behind flap per compartment</p> <p>Max. load: 40 kg</p>	<b>2 Raster carcass units</b>															
	 105,6 35,2 140.8 cm wide				 105,6 70,4 176.0 cm wide				 105,6 105,6 211.2 cm wide				 105,6 140,8 246.4 cm wide			
	as illustr. v. versa	<b>214491</b> <b>214492</b>	<b>276491</b> <b>276492</b>	<b>221491</b> <b>221492</b>	<b>224491</b> <b>224492</b>											
	<b>Price gr.</b> I II	- -	- -	- -	- -											
	 35,2 105,6 35,2 176.0 cm wide				 52,8 105,6 52,8 211.2 cm wide				 70,4 105,6 70,4 246.4 cm wide							
			<b>27649</b>	<b>22149</b>	<b>22449</b>											
	<b>Price gr.</b> I II		- -	- -	- -											
	<b>3 Raster carcass units</b>															
	 105,6 35,2 140.8 cm wide				 105,6 70,4 176.0 cm wide				 105,6 105,6 211.2 cm wide				 105,6 140,8 246.4 cm wide			
	as illustr. v. versa	<b>314491</b> <b>314492</b>	<b>376491</b> <b>376492</b>	<b>321491</b> <b>321492</b>	<b>324491</b> <b>324492</b>											
<b>Price gr.</b> I II	- -	- -	- -	- -												
 35,2 105,6 35,2 176.0 cm wide				 52,8 105,6 52,8 211.2 cm wide				 70,4 105,6 70,4 246.4 cm wide								
		<b>37649</b>	<b>32149</b>	<b>32449</b>												
<b>Price gr.</b> I II		- -	- -	- -												

## Metal substructures and glass cover shelves

Metal substructures and glass cover shelves see page 84.

## Centre partitions for carcass units

<b>Centre partitions for carcass units</b> 3.8 cm thick  <b>Depths:</b> 28.2 cm (for 30.3 cm depth), 40.2 cm (for 42.3 cm depth) or 47.2 cm (for 49.3 cm depth)  for fitting anywhere in carcass units within the Raster system  <b>Cannot be fitted on or below fitted glass shelves!</b>		for 1 Raster height			for 2 Raster height			for 3 Raster height			for 4 Raster height		
		for 30.3 cm depth	for 42.3 cm depth	for 49.3 cm depth	for 30.3 cm depth	for 42.3 cm depth	for 49.3 cm depth	for 30.3 cm depth	for 42.3 cm depth	for 49.3 cm depth	for 30.3 cm depth	for 42.3 cm depth	for 49.3 cm depth
	<b>130</b>	<b>140</b>	<b>147</b>	<b>230</b>	<b>240</b>	<b>247</b>	<b>330</b>	<b>340</b>	<b>347</b>	<b>430</b>	<b>440</b>	<b>447</b>	
<b>Price gr.</b>													
<b>I</b>	-	-	-	-	-	-	-	-	-	-	-	-	
<b>II</b>	-	-	-	-	-	-	-	-	-	-	-	-	

<b>NEW</b>		for 5 Raster height			for 6 Raster height			for 8 Raster height			for 10 Raster height			for 12 Raster height		
		for 30.3 cm depth	for 42.3 cm depth	for 49.3 cm depth	for 30.3 cm depth	for 42.3 cm depth	for 49.3 cm depth	for 30.3 cm depth	for 42.3 cm depth	for 49.3 cm depth	for 30.3 cm depth	for 42.3 cm depth	for 49.3 cm depth	for 30.3 cm depth	for 42.3 cm depth	for 49.3 cm depth
	<b>530</b>	<b>540</b>	<b>547</b>	<b>630</b>	<b>640</b>	<b>647</b>	<b>830</b>	<b>840</b>	<del>X</del>	<b>1030</b>	<b>1040</b>	<del>X</del>	<b>1230</b>	<b>1240</b>	<del>X</del>	
<b>Price gr.</b>																
<b>I</b>	-	-	-	-	-	-	-	-	-	-	-	-	-	-	-	
<b>II</b>	-	-	-	-	-	-	-	-	-	-	-	-	-	-	-	

## Constructional shelves for carcass units

<b>Constructional shelves for carcass units</b> 3.8 cm thick  <b>Depths:</b> 28.2 cm (for 30.3 cm depth), 40.2 cm (for 42.3 cm depth) or 47.2 cm (for 49.3 cm depth); for fitting anywhere in carcass units within the Raster system. If different fronts like drawers, flap units or doors are stacked on top of one another, constructional shelves must be fitted in between. If several drawers are fitted on top of one another, it is not necessary to fit a constructional shelf between the drawers.		for 17.6 cm width			for 35.2 cm width			for 52.8 cm width			for 70.4 cm width			for 105.6 cm width		
		for 30.3 cm depth	for 42.3 cm depth	for 49.3 cm depth	for 30.3 cm depth	for 42.3 cm depth	for 49.3 cm depth	for 30.3 cm depth	for 42.3 cm depth	for 49.3 cm depth	for 30.3 cm depth	for 42.3 cm depth	for 49.3 cm depth	for 30.3 cm depth	for 42.3 cm depth	for 49.3 cm depth
	<b>623</b>	<b>624</b>	<b>627</b>	<b>633</b>	<b>634</b>	<b>637</b>	<b>653</b>	<b>654</b>	<b>657</b>	<b>673</b>	<b>674</b>	<b>677</b>	<b>6103</b>	<b>6104</b>	<b>6107</b>	
<b>Price gr.</b>																
<b>I</b>	-	-	-	-	-	-	-	-	-	-	-	-	-	-	-	
<b>II</b>	-	-	-	-	-	-	-	-	-	-	-	-	-	-	-	

## Fitted shelves for carcass units

<b>Fitted shelves for carcass units</b> 1.9 cm thick  <b>Depths:</b> 28.2 cm (for 30.3 cm depth), 40.2 cm (for 42.3 cm depth) or 47.2 cm (for 49.3 cm depth)  for fitting anywhere in carcass units within the Raster system		for 17.6 cm width			for 35.2 cm width			for 52.8 cm width			for 70.4 cm width		
		for 30.3 cm depth	for 42.3 cm depth	for 49.3 cm depth	for 30.3 cm depth	for 42.3 cm depth	for 49.3 cm depth	for 30.3 cm depth	for 42.3 cm depth	for 49.3 cm depth	for 30.3 cm depth	for 42.3 cm depth	for 49.3 cm depth
	<b>123</b>	<b>124</b>	<b>127</b>	<b>133</b>	<b>134</b>	<b>137</b>	<b>153</b>	<b>154</b>	<b>157</b>	<b>173</b>	<b>174</b>	<b>177</b>	
<b>Price gr.</b>													
<b>I</b>	-	-	-	-	-	-	-	-	-	-	-	-	
<b>II</b>	-	-	-	-	-	-	-	-	-	-	-	-	

## Fitted glass shelves for carcass units

















<b>Fitted glass shelves for carcass units</b> 0.8 cm thick  <b>Depths:</b> 28.2 cm (for 30.3 cm depth), 40.2 cm (for 42.3 cm depth) or 47.2 cm (for 49.3 cm depth)  for fitting in carcass units. Glass shelves must be fitted between partitions and/or carcass sides. No partitions can be fitted on/under glass shelves.		for 17.6 cm width			for 35.2 cm width			for 52.8 cm width			for 70.4 cm width		
		for 30.3 cm depth	for 42.3 cm depth	for 49.3 cm depth	for 30.3 cm depth	for 42.3 cm depth	for 49.3 cm depth	for 30.3 cm depth	for 42.3 cm depth	for 49.3 cm depth	for 30.3 cm depth	for 42.3 cm depth	for 49.3 cm depth
	<b>323</b>	<b>324</b>	<b>327</b>	<b>333</b>	<b>334</b>	<b>337</b>	<b>353</b>	<b>354</b>	<b>357</b>	<b>373</b>	<b>374</b>	<b>377</b>	
<b>Price gr.</b>													
<b>I</b>	-	-	-	-	-	-	-	-	-	-	-	-	
<b>II</b>	-	-	-	-	-	-	-	-	-	-	-	-	

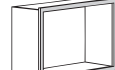

# Open compartments for carcass units

LED light strip for open compartments see page 86.

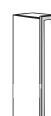
NEO

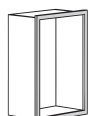
<b>Open compartments for carcass units</b>  for fitting in 1 Raster (or 2, 4 or 6 Raster) open sections of 30.3; 42.3 and 49.3 cm deep carcass units  1 Raster high = 17.2 cm 2 Raster high = 34.8 cm 4 Raster high = 70.0 cm 6 Raster high = 105.2 cm  incl. inside carcass with rear wall  for fitting between constructional shelves and partitions/carcass sides		1 Raster high			2 Raster high			4 Raster high			6 Raster high					
		for 30.3 cm depth	for 42.3 cm depth	for 49.3 cm depth	for 30.3 cm depth	for 42.3 cm depth	for 49.3 cm depth	for 30.3 cm depth	for 42.3 cm depth	for 49.3 cm depth	for 30.3 cm depth	for 42.3 cm depth	for 49.3 cm depth			
		Usable inside dims: Height: 9.4 cm Width: 27.0 cm Depth: 26.2; 38.2; 45.2 cm   for 35.2 cm width			Usable inside dims: Height: 9.4 cm Width: 44.5 cm Depth: 26.2; 38.2; 45.2 cm   for 52.8 cm width			Usable inside dims: Height: 9.4 cm Width: 62.2 cm Depth: 26.2; 38.2; 45.2 cm   for 70.4 cm width			Usable inside dims: Height: 9.4 cm Width: 97.4 cm Depth: 26.2; 38.2; 45.2 cm   for 105.6 cm width					
<b>Price gr.</b>		1835	1035	1535	1852	1052	1552	1870	1070	1570	18105	10105	15105			
I		-	-	-	-	-	-	-	-	-	-	-	-			
II		-	-	-	-	-	-	-	-	-	-	-	-			
		Usable inside dims: Height: 27.0 cm Width: 9.4 cm Depth: 26.2; 38.2; 45.2 cm   for 17.6 cm width			Usable inside dims: Height: 27.0 cm Width: 27.0 cm Depth: 26.2; 38.2; 45.2 cm   for 35.2 cm width			Usable inside dims: Height: 27.0 cm Width: 44.5 cm Depth: 26.2; 38.2; 45.2 cm   for 52.8 cm width			Usable inside dims: Height: 27.0 cm Width: 62.2 cm Depth: 26.2; 38.2; 45.2 cm   for 70.4 cm width			Usable inside dims: Height: 27.0 cm Width: 97.4 cm Depth: 26.2; 38.2; 45.2 cm   for 105.6 cm width		
<b>Price gr.</b>		2825	2025	2525	2835	2035	2535	2852	2052	2552	2870	2070	2570	28105	20105	25105
I		-	-	-	-	-	-	-	-	-	-	-	-	-	-	
II		-	-	-	-	-	-	-	-	-	-	-	-	-	-	
		Usable inside dims: Height: 62.2 cm Width: 9.4 cm Depth: 26.2; 38.2; 45.2 cm   for 17.6 cm width			Usable inside dims: Height: 62.2 cm Width: 27.0 cm Depth: 26.2; 38.2; 45.2 cm   for 35.2 cm width			Usable inside dims: Height: 62.2 cm Width: 44.5 cm Depth: 26.2; 38.2; 45.2 cm   for 52.8 cm width			Usable inside dims: Height: 62.2 cm Width: 62.2 cm Depth: 26.2; 38.2; 45.2 cm   for 70.4 cm width			Usable inside dims: Height: 62.2 cm Width: 97.4 cm Depth: 26.2; 38.2; 45.2 cm   for 105.6 cm width		
<b>Price gr.</b>		4825	4025	4525	4835	4035	4535	4852	4052	4552	4870	4070	4570	48105	40105	45105
I		-	-	-	-	-	-	-	-	-	-	-	-	-	-	
II		-	-	-	-	-	-	-	-	-	-	-	-	-	-	
		Usable inside dims: Height: 97.4 cm Width: 9.4 cm Depth: 26.2; 38.2; 45.2 cm   for 17.6 cm width			Usable inside dims: Height: 97.4 cm Width: 27.0 cm Depth: 26.2; 38.2; 45.2 cm   for 35.2 cm width			Usable inside dims: Height: 97.4 cm Width: 44.5 cm Depth: 26.2; 38.2; 45.2 cm   for 52.8 cm width								
<b>Price gr.</b>		6825	6025	6525	6835	6035	6535	6852	6052	6552						
I		-	-	-	-	-	-	-	-	-						
II		-	-	-	-	-	-	-	-	-						

## Fitted shelves for open compartment

Fitted shelves for open compartment 1.9 cm thick	for 17.6 cm width			for 35.2 cm width			for 52.8 cm width			for 70.4 cm width			for 105.6 cm width		
	for 30.3 cm depth	for 42.3 cm depth	for 49.3 cm depth	for 30.3 cm depth	for 42.3 cm depth	for 49.3 cm depth	for 30.3 cm depth	for 42.3 cm depth	for 49.3 cm depth	for 30.3 cm depth	for 42.3 cm depth	for 49.3 cm depth	for 30.3 cm depth	for 42.3 cm depth	for 49.3 cm depth
Depths: 26.2 cm (for 30.3 cm depth), 38.2 cm (for 42.3 cm depth) or 45.2 cm (for 49.3 cm depth)	523	524	527	533	534	537	553	554	557	573	574	577	513	514	517
for fitting anywhere in open compartments within the Raster system	-	-	-	-	-	-	-	-	-	-	-	-	-	-	-
Price gr.	-	-	-	-	-	-	-	-	-	-	-	-	-	-	-
	-	-	-	-	-	-	-	-	-	-	-	-	-	-	-

## Fitted glass shelves for open compartment

Fitted glass shelves (clear glass) for open compartment 0.8 cm thick	for 17.6 cm width			for 35.2 cm width			for 52.8 cm width			for 70.4 cm width			for 105.6 cm width		
	for 30.3 cm depth	for 42.3 cm depth	for 49.3 cm depth	for 30.3 cm depth	for 42.3 cm depth	for 49.3 cm depth	for 30.3 cm depth	for 42.3 cm depth	for 49.3 cm depth	for 30.3 cm depth	for 42.3 cm depth	for 49.3 cm depth	for 30.3 cm depth	for 42.3 cm depth	for 49.3 cm depth
Depths: 26.0 cm (for 30.3 cm depth), 38.0 cm (for 42.3 cm depth) or 45.0 cm (for 49.3 cm depth)	223	224	227	233	234	237	253	254	257	273	274	277	213	214	217
for fitting anywhere in open compartments within the Raster system	-	-	-	-	-	-	-	-	-	-	-	-	-	-	-

## Metal substructure

















Metal substructure 12.8 cm high; for 42.3 cm and 49.3 cm depth; High-gloss chrome												
Units, lowboards, side-/highboards and carcass units can be fitted optionally on a metal substructure. In this case the plinth adjusters are omitted.												
for 105.6 cm width		for 140.8 cm width		for 158.4 cm width		for 176.0 cm width		for 211.2 cm width		for 246.4 cm width		
for 42.3 cm depth	for 49.3 cm depth	for 42.3 cm depth	for 49.3 cm depth	for 42.3 cm depth	for 49.3 cm depth	for 42.3 cm depth	for 49.3 cm depth	for 42.3 cm depth	for 49.3 cm depth	for 42.3 cm depth	for 49.3 cm depth	
4012	5012	4412	5412	4512	5512	4712	5712	4112	5112	4612	5612	
-	-	-	-	-	-	-	-	-	-	-	-	

## Cover shelves

Cover shelf 2.9 cm thick; 33.0 cm, 45.0 cm or 52.0 cm deep, or 47.9 or 54.9 cm deep for room dividers					
All (carcase) units, low-, side- and highboards can be fitted with an extra cover shelf. We recommend fitting an extra cover shelf for visual reasons, if the (carcase) units, low-, side- and highboards are fitted between side-panels/converted with side-panels. The cover shelf is charged in 10 cm lengths or parts thereof. To make things easier, only the total width of the combination needs to be calculated here. The cover shelves are full-length up to a max. 299.2 cm width. Cover shelves are not available in high-gloss lacquer! In this case we recommend cover shelves of rear-lacquered glass (see below).					
Price per 10 cm section:					
	33.0 cm deep	45.0 cm deep	52.0 cm deep	47.9 cm deep (for room dividers)	54.9 cm deep (for room dividers)
	3515	3510	3517	3610	3617
Price gr.	-	-	-	-	-
	-	-	-	-	-























Cover shelves of rear-lacquered glass, optionally rear-lacquered in white, grey or silk grey 0.8 cm thick; 45.0 cm or 52.0 cm deep, or 47.9 or 54.9 cm deep for room dividers					
All (carcase) units, low-, side- and highboards can be fitted with an extra cover shelf. The cover shelf is charged in 10 cm lengths or parts thereof. To make things easier, only the total width of the combination needs to be calculated here. The cover shelves are full-length up to a max. 299.2 cm width.					
Please be sure to state the required version in the order!					
Price per 10 cm section:					
	33.0 cm deep	45.0 cm deep	52.0 cm deep	47.9 cm deep (for room dividers)	54.9 cm deep (for room dividers)
		3530	3537	3630	3637
		-	-	-	-





















1 and 2 Raster drawers

<p><b>Drawers</b>                  1 Raster high = 17.2 cm                  2 Raster high = 34.8 cm</p> <p>Front thickness: 2.3 cm</p> <p>for fitting between constructional shelves and partitions/ carcass sides</p> <p>If different fronts like drawers, flap units or doors are stacked on top of one another, constructional shelves must be fitted in between. If several drawers are fitted on top of one another, it is not necessary to fit a constructional shelf between the drawers.</p>	<b>1 Raster high</b>			<b>1 Raster high</b>			<b>1 Raster high</b>			<b>1 Raster high</b>			
	1 drawer			1 drawer			1 drawer			1 drawer			
													
	for 35.2 cm width			for 52.8 cm width			for 70.4 cm width			for 105.6 cm width			
		for 30.3 cm depth	for 42.3 cm depth	for 49.3 cm depth	for 30.3 cm depth	for 42.3 cm depth	for 49.3 cm depth	for 30.3 cm depth	for 42.3 cm depth	for 49.3 cm depth	for 30.3 cm depth	for 42.3 cm depth	for 49.3 cm depth
		<b>1331</b>	<b>1301</b>	<b>1371</b>	<b>1531</b>	<b>1501</b>	<b>1571</b>	<b>1731</b>	<b>1701</b>	<b>1771</b>	<b>11031</b>	<b>11001</b>	<b>11071</b>
	<b>Price gr.</b>	-	-	-	-	-	-	-	-	-	-	-	-
	<b>I</b>	-	-	-	-	-	-	-	-	-	-	-	-
	<b>II</b>	-	-	-	-	-	-	-	-	-	-	-	-
	<b>2 Raster high</b>			<b>2 Raster high</b>			<b>2 Raster high</b>			<b>2 Raster high</b>			
1 drawer			1 drawer			1 drawer			1 drawer				
													
for 35.2 cm width			for 52.8 cm width			for 70.4 cm width			for 105.6 cm width				
	for 30.3 cm depth	for 42.3 cm depth	for 49.3 cm depth	for 30.3 cm depth	for 42.3 cm depth	for 49.3 cm depth	for 30.3 cm depth	for 42.3 cm depth	for 49.3 cm depth	for 30.3 cm depth	for 42.3 cm depth	for 49.3 cm depth	
	<b>2332</b>	<b>2302</b>	<b>2372</b>	<b>2532</b>	<b>2502</b>	<b>2572</b>	<b>2732</b>	<b>2702</b>	<b>2772</b>	<b>21032</b>	<b>21002</b>	<b>21072</b>	
<b>Price gr.</b>	-	-	-	-	-	-	-	-	-	-	-	-	
<b>I</b>	-	-	-	-	-	-	-	-	-	-	-	-	
<b>II</b>	-	-	-	-	-	-	-	-	-	-	-	-	
<b>2 Raster high</b>			<b>2 Raster high</b>			<b>2 Raster high</b>			<b>2 Raster high</b>				
bottom 1 Raster drawer with 2 Raster front panel, top 1 Raster inside drawer			bottom 1 Raster drawer with 2 Raster front panel, top 1 Raster inside drawer			bottom 1 Raster drawer with 2 Raster front panel, top 1 Raster inside drawer			bottom 1 Raster drawer with 2 Raster front panel, top 1 Raster inside drawer				
													
for 35.2 cm width			for 52.8 cm width			for 70.4 cm width			for 105.6 cm width				
	for 30.3 cm depth	for 42.3 cm depth	for 49.3 cm depth	for 30.3 cm depth	for 42.3 cm depth	for 49.3 cm depth	for 30.3 cm depth	for 42.3 cm depth	for 49.3 cm depth	for 30.3 cm depth	for 42.3 cm depth	for 49.3 cm depth	
	<b>431</b>	<b>401</b>	<b>471</b>	<b>432</b>	<b>402</b>	<b>472</b>	<b>433</b>	<b>403</b>	<b>473</b>	<b>434</b>	<b>404</b>	<b>474</b>	
<b>Price gr.</b>	-	-	-	-	-	-	-	-	-	-	-	-	
<b>I</b>	-	-	-	-	-	-	-	-	-	-	-	-	
<b>II</b>	-	-	-	-	-	-	-	-	-	-	-	-	
<b>2 Raster high</b>			<b>2 Raster high</b>			<b>2 Raster high</b>			<b>2 Raster high</b>				
2 drawers			2 drawers			2 drawers			2 drawers				
													
for 35.2 cm width			for 52.8 cm width			for 70.4 cm width			for 105.6 cm width				
	for 30.3 cm depth	for 42.3 cm depth	for 49.3 cm depth	for 30.3 cm depth	for 42.3 cm depth	for 49.3 cm depth	for 30.3 cm depth	for 42.3 cm depth	for 49.3 cm depth	for 30.3 cm depth	for 42.3 cm depth	for 49.3 cm depth	
	<b>2331</b>	<b>2301</b>	<b>2371</b>	<b>2531</b>	<b>2501</b>	<b>2571</b>	<b>2731</b>	<b>2701</b>	<b>2771</b>	<b>21031</b>	<b>21001</b>	<b>21071</b>	
<b>Price gr.</b>	-	-	-	-	-	-	-	-	-	-	-	-	
<b>I</b>	-	-	-	-	-	-	-	-	-	-	-	-	
<b>II</b>	-	-	-	-	-	-	-	-	-	-	-	-	

# Fronts for carcass units

## 1 and 2 Raster flaps

<p><b>Flaps</b>                      1 Raster high = 17.2 cm                      2 Raster high = 34.8 cm</p> <p>Front thickness: 2.3 cm</p> <p>for fitting between constructional shelves and partitions/ carcass sides</p> <p>If different fronts like drawers, flap units or doors are stacked on top of one another, constructional shelves must be fitted in between. If several drawers are fitted on top of one another, it is not necessary to fit a constructional shelf between the drawers.</p>	<b>1 Raster high</b>						
	1 flap					1 fabric-covered flap	
	 for 35.2 cm width					 for 52.8 cm width	 for 70.4 cm width
	 for 105.6 cm width					 for 105.6 cm width	
	Flap hinge at bottom					Flap hinge at bottom	Flap hinge at bottom
	<b>1308</b>					<b>1508</b>	<b>1708</b>
	-					-	-
	-					-	-
	<b>2 Raster high</b>						
	1 flap					1 flap	1 fabric-covered flap
	 for 35.2 cm width					 for 52.8 cm width	 for 70.4 cm width
	 for 105.6 cm width					 for 105.6 cm width	
	Flap hinge at bottom					Flap hinge at bottom	Flap hinge at bottom
	<b>2308</b>					<b>2508</b>	<b>2708</b>
	-					-	-
-					-	-	
<b>2 Raster high</b>							
1 flap					1 flap	1 flap	
 for 35.2 cm width					 for 52.8 cm width	 for 70.4 cm width	
 for 105.6 cm width							
Flap hinge at top					Flap hinge at top	Flap hinge at top	
<b>2309</b>					<b>2509</b>	<b>2709</b>	
-					-	-	
-					-	-	
<b>2 Raster high</b>							
1 glass flap					1 glass flap	1 glass flap	
 for 35.2 cm width					 for 52.8 cm width	 for 70.4 cm width	
 for 105.6 cm width							
Flap hinge at bottom					Flap hinge at bottom	Flap hinge at bottom	
<b>2304</b>					<b>2504</b>	<b>2704</b>	
-					-	-	
<b>2 Raster high</b>							
1 glass flap					1 glass flap	1 glass flap	
 for 35.2 cm width					 for 52.8 cm width	 for 70.4 cm width	
 for 105.6 cm width							
Flap hinge at top					Flap hinge at top	Flap hinge at top	
<b>2305</b>					<b>2505</b>	<b>2705</b>	
-					-	-	

1 flap  for 140.8 cm width		1 flap  for 176.0 cm width	1 flap  for 211.2 cm width	1 flap  for 246.4 cm width
Flap hinge at bottom		Flap hinge at bottom	Flap hinge at bottom	Flap hinge at bottom
<b>11408</b> -		<b>11708</b> -	<b>12108</b> -	<b>12408</b> -
1 flap  for 140.8 cm width		1 flap  for 176.0 cm width	1 flap  for 211.2 cm width	1 flap  for 246.4 cm width
Flap hinge at bottom		Flap hinge at bottom	Flap hinge at bottom	Flap hinge at bottom
<b>21408</b> -		<b>21708</b> -	<b>22108</b> -	<b>22408</b> -
1 flap  for 140.8 cm width		1 flap  for 176.0 cm width	1 flap  for 211.2 cm width	1 flap  for 246.4 cm width
Flap hinge at top		Flap hinge at top	Flap hinge at top	Flap hinge at top
<b>21409</b> -		<b>21709</b> -	<b>22109</b> -	<b>22409</b> -
1 glass flap  for 140.8 cm width		1 glass flap  for 176.0 cm width	1 glass flap  for 211.2 cm width	1 glass flap  for 246.4 cm width
Flap hinge at bottom		Flap hinge at bottom	Flap hinge at bottom	Flap hinge at bottom
<b>21404</b> -		<b>21704</b> -	<b>22104</b> -	<b>22404</b> -
1 glass flap  for 140.8 cm width		1 glass flap  for 176.0 cm width	1 glass flap  for 211.2 cm width	1 glass flap  for 246.4 cm width
Flap hinge at top		Flap hinge at top	Flap hinge at top	Flap hinge at top
<b>21405</b> -		<b>21705</b> -	<b>22105</b> -	<b>22405</b> -











# Fronts for carcass units

## 2 - 5 Raster doors











**Doors**  
 2 Raster high = 34.8 cm  
 3 Raster high = 52.4 cm  
 4 Raster high = 70.0 cm  
 5 Raster high = 87.6 cm  
 Front thickness: 2.3 cm

for fitting between constructional shelves and partitions/ carcass sides

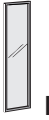
If different fronts like drawers, flap units or doors are stacked on top of one another, constructional shelves must be fitted in between. If several drawers are fitted on top of one another, it is not necessary to fit a constructional shelf between the drawers.

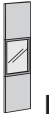









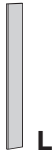

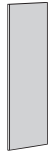
	<b>2 Raster high</b>			
	1 door  for 17.6 cm width			
<b>Price gr.</b>	<b>20111 L</b> <b>20112 R</b> - -			
	<b>3 Raster high</b>			
	1 door  for 17.6 cm width		1 door  for 35.2 cm width	
<b>Price gr.</b>	<b>30111 L</b> <b>30112 R</b> - -		<b>30311 L</b> <b>30312 R</b> - -	
	<b>4 Raster high</b>			
	1 door  for 17.6 cm width		1 door  for 35.2 cm width	
<b>Price gr.</b>	<b>40111 L</b> <b>40112 R</b> - -		<b>40311 L</b> <b>40312 R</b> - -	
	<b>4 Raster high</b>			
			1 glass door  for 35.2 cm width	
<b>Price gr.</b>			<b>40341 L</b> <b>40342 R</b> - -	
	<b>5 Raster high</b>			
	<b>NEW</b> 1 door  for 17.6 cm width		1 door  for 35.2 cm width	
<b>Price gr.</b>	<b>50111 L</b> <b>50112 R</b> - -		<b>50311 L</b> <b>50312 R</b> - -	
	<b>5 Raster high</b>			
	<b>NEW</b> 1 glass door  for 35.2 cm width		1 glass door  for 52.8 cm width	
<b>Price gr.</b>			<b>50341 L</b> <b>50342 R</b> - -	

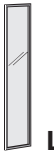
6 Raster doors

<p><b>Doors</b>                  6 Raster high = 105.2 cm                  Front thickness: 2.3 cm</p> <p>for fitting between constructional shelves and partitions/ carcass sides</p> <p>If different fronts like drawers, flap units or doors are stacked on top of one another, constructional shelves must be fitted in between. If several drawers are fitted on top of one another, it is not necessary to fit a constructional shelf between the drawers.</p>	1 door	1 door	1 door	1 door
				
	for 17.6 cm width	for 35.2 cm width	for 52.8 cm width	for 70.4 cm width
	<b>60111 L</b> <b>60112 R</b>	<b>60311 L</b> <b>60312 R</b>	<b>60511 L</b> <b>60512 R</b>	<b>60711 L</b> <b>60712 R</b>
	Price gr. I II	- -	- -	- -
		1 glass door	1 glass door	1 glass door
				
		for 35.2 cm width	for 52.8 cm width	for 70.4 cm width
		<b>60341 L</b> <b>60342 R</b>	<b>60541 L</b> <b>60542 R</b>	<b>60741 L</b> <b>60742 R</b>
		-	-	-
	1 glass door/door	1 glass door/door	1 glass door/door	
				
	for 35.2 cm width	for 52.8 cm width	for 70.4 cm width	
<b>61341 L</b> <b>61342 R</b>	<b>61541 L</b> <b>61542 R</b>	<b>61741 L</b> <b>61742 R</b>		
Price gr. I II	- -	- -	- -	
		1 glass door/door	1 glass door/door	
				
		for 52.8 cm width	for 70.4 cm width	
		<b>62541 L</b> <b>62542 R</b>	<b>62741 L</b> <b>62742 R</b>	
as illustr. (L) v. versa (R) Price gr. I II		- -	- -	



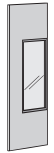





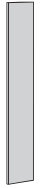

# Fronts for carcass units

## 8 Raster doors

<p><b>Doors</b> 8 Raster high = 140.4 cm Front thickness: 2.3 cm</p> <p>for fitting between constructional shelves and partitions/ carcass sides</p> <p>If different fronts like drawers, flap units or doors are stacked on top of one another, constructional shelves must be fitted in between. If several drawers are fitted on top of one another, it is not necessary to fit a constructional shelf between the drawers.</p>	1 door	1 door	1 door	1 door
				
	for 17.6 cm width	for 35.2 cm width	for 52.8 cm width	for 70.4 cm width
	<b>80111 L</b> <b>80112 R</b>	<b>80311 L</b> <b>80312 R</b>	<b>80511 L</b> <b>80512 R</b>	<b>80711 L</b> <b>80712 R</b>
	Price gr. I II	- -	- -	- -
		1 glass door	1 glass door	1 glass door
				
		for 35.2 cm width	for 52.8 cm width	for 70.4 cm width
		<b>80341 L</b> <b>80342 R</b>	<b>80541 L</b> <b>80542 R</b>	<b>80741 L</b> <b>80742 R</b>
		-	-	-
	1 glass door/door	1 glass door/door	1 glass door/door	
				
	for 35.2 cm width	for 52.8 cm width	for 70.4 cm width	
<b>81341 L</b> <b>81342 R</b>	<b>81541 L</b> <b>81542 R</b>	<b>81741 L</b> <b>81742 R</b>		
Price gr. I II	- -	- -	- -	
		1 glass door/door	1 glass door/door	
				
		for 52.8 cm width	for 70.4 cm width	
as illustr. (L) v. versa (R)		<b>82541 L</b> <b>82542 R</b>	<b>82741 L</b> <b>82742 R</b>	
Price gr. I II		- -	- -	

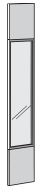

10 Raster doors

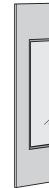
<p><b>Doors</b>                  10 Raster high = 175.6 cm                  Front thickness: 2.3 cm</p> <p>for fitting between constructional shelves and partitions/ carcass sides</p> <p>If different fronts like drawers, flap units or doors are stacked on top of one another, constructional shelves must be fitted in between. If several drawers are fitted on top of one another, it is not necessary to fit a constructional shelf between the drawers.</p>	1 door		1 door		1 door		1 door		
									
	for 17.6 cm width		for 35.2 cm width		for 52.8 cm width		for 70.4 cm width		
	Price gr. I II	100111 L 100112 R		100311 L 100312 R		100511 L 100512 R		100711 L 100712 R	
		-		-		-		-	
			1 glass door		1 glass door		1 glass door		
									
			for 35.2 cm width		for 52.8 cm width		for 70.4 cm width		
			100341 L 100342 R		100541 L 100542 R		100741 L 100742 R		
			-		-		-		
		1 glass door/door		1 glass door/door		1 glass door/door			
									
		for 35.2 cm width		for 52.8 cm width		for 70.4 cm width			
Price gr. I II	101341 L 101342 R		101541 L 101542 R		101741 L 101742 R				
	-		-		-				
				1 glass door/door		1 glass door/door			
									
				for 52.8 cm width		for 70.4 cm width			
as illustr. (L) v. versa (R) Price gr. I II					102541 L 102542 R		102741 L 102742 R		
					-		-		











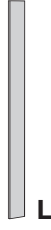

# Fronts for carcass units

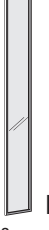
## 12 Raster doors

**Doors**  
 12 Raster high = 210.8 cm  
 Front thickness: 2.3 cm

for fitting between constructional shelves and partitions/ carcass sides

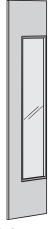
If different fronts like drawers, flap units or doors are stacked on top of one another, constructional shelves must be fitted in between. If several drawers are fitted on top of one another, it is not necessary to fit a constructional shelf between the drawers.

	1 door  for 17.6 cm width	1 door  for 35.2 cm width	1 door  for 52.8 cm width	1 door  for 70.4 cm width
<b>Price gr.</b> I II	<b>120111 L</b> <b>120112 R</b> - -	<b>120311 L</b> <b>120312 R</b> - -	<b>120511 L</b> <b>120512 R</b> - -	<b>120711 L</b> <b>120712 R</b> - -
		1 glass door  for 35.2 cm width	1 glass door  for 52.8 cm width	1 glass door  for 70.4 cm width
		<b>120341 L</b> <b>120342 R</b> -	<b>120541 L</b> <b>120542 R</b> -	<b>120741 L</b> <b>120742 R</b> -
		1 glass door/door  for 35.2 cm width	1 glass door/door  for 52.8 cm width	1 glass door/door  for 70.4 cm width
<b>Price gr.</b> I II		<b>121341 L</b> <b>121342 R</b> - -	<b>121541 L</b> <b>121542 R</b> - -	<b>121741 L</b> <b>121742 R</b> - -
			1 glass door/door  for 52.8 cm width	1 glass door/door  for 70.4 cm width
<b>Price gr.</b> I II			<b>122541 L</b> <b>122542 R</b> - -	<b>122741 L</b> <b>122742 R</b> - -
as illustr. (L) v. versa (R)				



# Rear wall panelling (room dividers)

## Rear wall panelling (room dividers)

































(Carcase) units, low-, side- and highboards can also be used optionally as room dividers. In this case extra rear wall panelling must be ordered.

Horizontal veneer direction for 1 and 2 Raster high units and vertical direction from 3 Raster high units.

### Rear wall panelling

- 1 Raster high = 17.2 cm
- 2 Raster high = 34.8 cm
- 3 Raster high = 52.4 cm
- 4 Raster high = 70.0 cm
- 5 Raster high = 87.6 cm
- 6 Raster high = 105.2 cm

























Units which are placed centrally in the room (room dividers) must be fitted with rear wall panelling.

<b>1 Raster high</b>		 for 35.2 cm width	 for 52.8 cm width	 for 70.4 cm width	 for 105.6 cm width	
<b>Price gr.</b>		<b>1930</b>	<b>1950</b>	<b>1970</b>	<b>19100</b>	
<b>I</b>		-	-	-	-	
<b>II</b>		-	-	-	-	
<b>2 Raster high</b>		 for 17.6 cm width	 for 35.2 cm width	 for 52.8 cm width	 for 70.4 cm width	 for 105.6 cm width
	<b>2910</b>	<b>2930</b>	<b>2950</b>	<b>2970</b>	<b>29100</b>	
<b>Price gr.</b>		-	-	-	-	
<b>I</b>		-	-	-	-	
<b>II</b>		-	-	-	-	
<b>2 Raster high</b>		 for 35.2 cm width	 for 52.8 cm width	 for 70.4 cm width	 for 105.6 cm width	
		<b>2931</b>	<b>2951</b>	<b>2971</b>	<b>29101</b>	
<b>Price gr.</b>		-	-	-	-	
<b>I</b>		-	-	-	-	
<b>II</b>		-	-	-	-	
<b>3 Raster high</b>		 for 17.6 cm width	 for 35.2 cm width	 for 52.8 cm width	 for 70.4 cm width	 for 105.6 cm width
	<b>3910</b>	<b>3930</b>	<b>3950</b>	<b>3970</b>	<b>39100</b>	
<b>Price gr.</b>		-	-	-	-	
<b>I</b>		-	-	-	-	
<b>II</b>		-	-	-	-	
<b>4 Raster high</b>		 for 17.6 cm width	 for 35.2 cm width	 for 52.8 cm width	 for 70.4 cm width	 for 105.6 cm width
	<b>4910</b>	<b>4930</b>	<b>4950</b>	<b>4970</b>	<b>49100</b>	
<b>Price gr.</b>		-	-	-	-	
<b>I</b>		-	-	-	-	
<b>II</b>		-	-	-	-	
<b>5 Raster high</b>		 for 17.6 cm width	 for 35.2 cm width	 for 52.8 cm width	 for 70.4 cm width	 for 105.6 cm width
	<b>5910</b>	<b>5930</b>	<b>5950</b>	<b>5970</b>	<b>59100</b>	
<b>Price gr.</b>		-	-	-	-	
<b>I</b>		-	-	-	-	
<b>II</b>		-	-	-	-	
<b>6 Raster high</b>		 for 17.6 cm width	 for 35.2 cm width	 for 52.8 cm width	 for 70.4 cm width	 for 105.6 cm width
	<b>6910</b>	<b>6930</b>	<b>6950</b>	<b>6970</b>	<b>69100</b>	
<b>Price gr.</b>		-	-	-	-	
<b>I</b>		-	-	-	-	
<b>II</b>		-	-	-	-	

**NEW**

**Important notes:**

Low-, side- and highboards in 45.0 and 52.0 cm depth and 1 to 6 Raster (carcase) units, which are at least 140.8 cm wide themselves or put together in a combination of several units, can be used as room dividers. The rear walls of clearly defined room-divider single units are panelled to look like a door if not otherwise stated in the order. The rear wall panelling is split in the middle in the case of 6 Raster high units from a width of 105.6 cm. If required, the rear walls can be designed separately for each unit when placing units anywhere (free planning). This must be stated clearly in the order.

 for 140.8 cm width	For 158.4 cm width please use the rear wall panelling in 52.8; 70.4 and 105.6 cm width. for 158.4 cm width	 for 176.0 cm width	 for 211.2 cm width	 for 246.4 cm width
<b>19140</b> - -	X	<b>19170</b> - -	<b>19210</b> - -	<b>19240</b> - -
 for 140.8 cm width	For 158.4 cm width please use the rear wall panelling in 52.8; 70.4 and 105.6 cm width. for 158.4 cm width	 for 176.0 cm width	 for 211.2 cm width	 for 246.4 cm width
<b>29140</b> - -	X	<b>29170</b> - -	<b>29210</b> - -	<b>29240</b> - -
 for 140.8 cm width	For 158.4 cm width please use the rear wall panelling in 52.8; 70.4 and 105.6 cm width. for 158.4 cm width	 for 176.0 cm width	 for 211.2 cm width	 for 246.4 cm width
<b>39140</b> - -	X	<b>39170</b> - -	<b>39210</b> - -	<b>39240</b> - -
 for 140.8 cm width	For 158.4 cm width please use the rear wall panelling in 52.8; 70.4 and 105.6 cm width. for 158.4 cm width	 for 176.0 cm width	 for 211.2 cm width	 for 246.4 cm width
<b>49140</b> - -	X	<b>49170</b> - -	<b>49210</b> - -	<b>49240</b> - -
 for 140.8 cm width	For 158.4 cm width please use the rear wall panelling in 52.8; 70.4 and 105.6 cm width. for 158.4 cm width	 for 176.0 cm width	 for 211.2 cm width	 for 246.4 cm width
<b>59140</b> - -	X	<b>59170</b> - -	<b>59210</b> - -	<b>59240</b> - -
 for 140.8 cm width	For 158.4 cm width please use the rear wall panelling in 52.8; 70.4 and 105.6 cm width. for 158.4 cm width	 for 176.0 cm width	 for 211.2 cm width	 for 246.4 cm width
<b>69140</b> - -	X	<b>69170</b> - -	<b>69210</b> - -	<b>69240</b> - -

## Side-panels

<p><b>Side-panels</b> 2.9 cm thick; 33.0 cm deep</p> <p>Side-panels incl. 1.8 cm high plinth adjusters</p> <p>Please allow 2.5 cm gap to the ceiling and at the side for assembly in each project!</p> <p>With ceiling-high side-panels: please state true room height!</p> <p>Height reductions of ceiling high side-panels (max. 263.9 cm) down to 12 Raster (215.9 cm) without surcharge.</p> <p>The extra high side-panels (max. 424.2 cm) are always split at 12 Raster height (215.9 cm). Height reductions without surcharge.</p>						
		<b>8 Raster</b> (145.5 cm high)	<b>10 Raster</b> (180.7 cm high)	<b>12 Raster</b> (215.9 cm high)	<b>Ceiling-high side-panel</b> (up to max. 263.9 cm) incl. ceiling fitting bracket	<b>Extra-high side-panel</b> (up to max. 424.2 cm) incl. ceiling fitting bracket
	<b>Price gr.</b>	<b>836</b>	<b>1036</b>	<b>1236</b>	<b>1636</b>	<b>2436</b>
<b>I</b>	-	-	-	-	-	
<b>II</b>	-	-	-	-	-	

## Wall side-panels

<p><b>Wall side-panels</b> 2.9 cm thick; 33.0 cm deep</p> <p>Please allow 2.5 cm gap to the ceiling and at the side for assembly in each project!</p> <p>The wall side-panels may only be fitted on absolutely solid walls. Gypsum or other light masonry is not suitable for this purpose. Max. load of a wall side-panel column (consisting of 2 wall side-panels and fitted shelves): 125 kg.</p> <p>Lamps cannot be fitted on wall side-panels.</p>						
		<b>2 Raster</b> (38.1 cm high)	<b>4 Raster</b> (73.3 cm high)	<b>6 Raster</b> (108.5 cm high)	<b>8 Raster</b> (143.7 cm high)	<b>10 Raster</b> (178.9 cm high)
	<b>Price gr.</b>	<b>235</b>	<b>435</b>	<b>635</b>	<b>835</b>	<b>135</b>
<b>I</b>	-	-	-	-	-	
<b>II</b>	-	-	-	-	-	

## Corner solutions for side-panels

<b>Cannot be fitted in combinations with wall side-panels!</b>							
	<p><b>Fitted corner shelf</b> 2.9 cm thick; 74.3 x 74.3 cm</p>					<b>774</b>	
	<b>Price gr.</b>					-	
	<b>II</b>					-	
	<p><b>Corner slat for fitted corner shelves</b> 3.9 x 3.9 cm</p>	Height:	<b>8 Raster</b>	<b>10 Raster</b>	<b>12 Raster</b>	<b>ceiling high</b>	<b>for extra heights</b>
			<b>86</b>	<b>106</b>	<b>126</b>	<b>166</b>	<b>246</b>
	<b>Price gr.</b>						
	<b>I</b>		-	-	-	-	-
	<b>II</b>		-	-	-	-	-

## Fitted wooden shelves for (wall) side-panels

NEO

<b>Fitted wooden shelves for (wall) side-panels</b> 2.9 cm thick; 33.0 cm deep						
		17.6 cm wide	35.2 cm wide	52.8 cm wide	70.4 cm wide	105.6 cm wide
<b>Price gr.</b>	<b>1703</b>	<b>3503</b>	<b>5203</b>	<b>7003</b>	<b>10503</b>	<b>14003</b>
	-	-	-	-	-	-

## Fitted glass shelves for (wall) side-panels

<b>Fitted glass shelves (clear glass) for (wall) side-panels</b> 0.8 cm thick; 32.8 cm deep  If fitted glass shelves are fitted in side-panels, fitted wooden shelves must be included at the top and bottom of this side-panel column for constructional reasons.						
		17.6 cm wide	35.2 cm wide	52.8 cm wide	70.4 cm wide	105.6 cm wide
	<b>1733</b>	<b>3533</b>	<b>5233</b>	<b>7033</b>	<b>10533</b>	
	-	-	-	-	-	

## Wall shelves

<b>Wall shelves</b> 2.9 cm thick; 23.4 cm deep  for fitting anywhere on walls  LED lamps for wall shelves: see below!					
		35.2 cm wide	52.8 cm wide	70.4 cm wide	105.6 cm wide
<b>Price gr.</b>	<b>3524</b>	<b>5224</b>	<b>7024</b>	<b>1024</b>	<b>1424</b>
	-	-	-	-	-

## LED lamps for wall shelves

This luminaire contains built-in LED lamps of the energy classes A++ to A. The lamps cannot be changed in the luminaire. 12 V			LED lamps incl. footswitch. A remote control unit is possible for operation (against a surcharge).		
<b>LED lamps for wall shelves</b>			4.7 W	6.3 W	10.2 W
	for 35.2 cm width	for 52.8 cm width	for 70.4 cm width	for 105.6 cm width	for 140.8 cm width
			<b>822</b>	<b>112</b>	<b>142</b>
			-	-	-

# Niche rear walls for side-panels

## Niche rear walls for side-panels

Niche rear walls – 1.1 cm thick – (space required 2.7 cm), can be fitted between side-panels, 1-12 Raster high. Fitted shelves can be planned anywhere. It is not possible to fit a rear wall later. **Rear walls with all-round brush seal.**

When integrated LED spotlamps are fitted, the niche rear wall must be split at the height of the lamps. Please remember this when planning!

Floor plan for a rear wall in a side-panel column

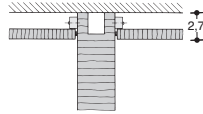

Side view for a rear wall in a side-panel column

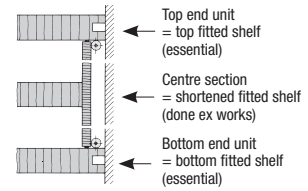





		for 1 Raster height (17.6 cm high)	for 2 Raster height (35.2 cm high)	for 3 Raster height (52.8 cm high)	for 4 Raster height (70.4 cm high)	for 6 Raster height (105.6 cm high)	for 8 Raster height (140.8 cm high)	for 10 Raster height (176.0 cm high)	for 12 Raster height (211.2 cm high)
for 17.6 cm width	Price gr. I II	1199 - -	2199 - -	3199 - -	4199 - -	6199 - -	8199 - -	10199 - -	12199 - -
for 35.2 cm width	Price gr. I II	1399 - -	2399 - -	3399 - -	4399 - -	6399 - -	8399 - -	10399 - -	12399 - -
for 52.8 cm width	Price gr. I II	1599 - -	2599 - -	3599 - -	4599 - -	6599 - -	8599 - -	10599 - -	12599 - -
for 70.4 cm width	Price gr. I II	1799 - -	2799 - -	3799 - -	4799 - -	6799 - -	8799 - -	10799 - -	12799 - -
for 105.6 cm width	Price gr. I II	11099 - -	21099 - -	31099 - -	41099 - -	61099 - -	81099 - -	101099 - -	121099 - -
for 140.8 cm width (split in the middle)	Price gr. I II	11499 - -	21499 - -	31499 - -	41499 - -	61499 - -	81499 - -	101499 - -	121499 - -



# Lamps for side-panels

Lamps cannot be fitted on wall side-panels.

NEO

This luminaire contains built-in LED lamps of the energy classes A++ to A. The lamps cannot be changed in the luminaire. 12 V	LED lamps incl. foot switch. A radio remote control is possible for operation (against a surcharge).				
<p><b>LED light strip</b> 1.0 cm thick, 1.1 cm deep</p> 	for 35.2 cm width	for 52.8 cm width	for 70.4 cm width	for 105.6 cm width	for 140.8 cm width
	1.6 W	2.4 W	4.7 W	6.3 W	10.2 W
	322	522	822	112	142
	-	-	-	-	-
<p><b>LED light panel</b> 1.9 cm thick; 3.0 cm deep</p>  	2.4 W	3.9 W	5.1 W	7.8 W	X
	328	528	828	118	
	-	-	-	-	-
<p><b>Integrated power LED spotlamp</b> Ø 7.1 cm</p> 	2.9 W				
	2.9 W				
	7941				
	-				

## Magic-Tronic

The lamps are normally operated by an external footswitch. As an alternative we can also provide a Magic-Tronic switch, which is charged extra. By "stroking" the outer or top side of the unit at the same level as the invisible integrated sensor it is possible to switch all the lamps on and off ("Stroking method"). As an alternative the position of the hidden sensor can also be marked with a small metal plate on the furniture unit ("Marking method"). Lamps with a maximum power of 200 W can be operated by a Magic-Tronic unit (230 V). The footswitch is omitted when a Magic-Tronic unit is included.

Please be sure to observe the information and notes regarding the assembly position!

<b>7617</b>
-

## NEW Remote control unit with changing colours



The lamps are normally operated by an external footswitch. The colour temperature of the LED lamps is cold white if a footswitch is used. A 4-channel remote control unit, which is charged extra, is also available as an alternative. Several lamps (up to a total load of a maximum 30 W per transformer and receiver) can be operated with each of the 4 channels. All 4 channels can be dimmed separately at the push of a button. The colour temperature of all 4 channels can be set to any level from cold white (approx. 6500 kelvin = the basic setting of the LED lamps) to warm white (approx. 2700 kelvin). If warm white is required, a radio remote control unit must be ordered. It is also possible to switch all channels on and off simultaneously with the "all on" or "all off" buttons. Up to 4 transmitters can operate as many receivers as required. Transmitters and receivers must be ordered separately. The footswitch is omitted when the remote control unit is used.



Price per transmitter	Price per receiver
<b>2316</b>	<b>2317</b>
-	-

## Accessories for carcass units

### Fitted shelves

			for 17.6 cm width	for 35.2 cm width	for 52.8 cm width	for 70.4 cm width	for 105.6 cm width
 <p><b>Fitted shelf</b> 1.9 cm thick</p>	for 33.0 cm depth	<b>Price gr.</b> I II	123 - -	133 - -	153 - -	173 - -	1103 - -
	for 45.0 cm depth	<b>Price gr.</b> I II	124 - -	134 - -	154 - -	174 - -	1104 - -
	for 52.0 cm depth	<b>Price gr.</b> I II	127 - -	137 - -	157 - -	177 - -	1107 - -
 <p><b>Glass shelf</b> (clear glass) 0.8 cm thick</p>	for 33.0 cm depth		323 -	333 -	353 -	373 -	X
	for 45.0 cm depth		324 -	334 -	354 -	374 -	
	for 52.0 cm depth		327 -	337 -	357 -	377 -	



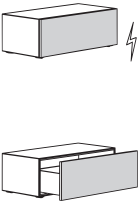

### hülsta Push-to-open with motor-driven support for drawers

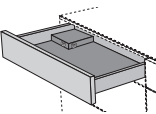
			for 35.2 cm width	for 52.8 cm width	for 70.4 cm width	for 105.6 cm width
 <p><b>hülsta Push-to-open with motor-driven support for drawers</b></p> <p>The drawers can be fitted with an optional hülsta Push-to-open device with motor-driven support. The drawer opens automatically when pressed lightly.</p> <p>Not possible for 1 Raster fronts for 35.2 cm width and in 33.0 cm depth.</p>	for 45.0 and 52.0 cm depth		Not possible for 1 Raster fronts!			
			50 -	54 -	57 -	51 -

### Accessories for drawers

			for 35.2 cm width	for 52.8 cm width	for 70.4 cm width	for 105.6 cm width
 <p><b>Tableau</b> lined with grey fabric</p>	for 33.0 cm depth		8620 -	8621 -	8622 -	8623 -
	for 45.0 cm depth for floor units		8624 -	8625 -	8626 -	8627 -
	for 45.0 cm depth for wall/stacked units		9624 -	9625 -	9626 -	9627 -
	for 52.0 cm depth		8628 -	8629 -	8630 -	8631 -
 <p><b>USB charging station</b> with two double USB connections (for mobiles, tablets, etc.); current strength per double USB connection: 1x max. 2.100 mA or 2x 1.050 mA. The USB charging station is only suitable for devices that are compatible with the above power level data. Connection cable between USB charging station and device is not supplied.</p>	for 33.0 cm depth		8520 -	8521 -	8522 -	X
	for 45.0 cm depth for floor units		8524 -	8525 -	8526 -	
	for 45.0 cm depth for wall/stacked units		9524 -	9525 -	9526 -	
	for 52.0 cm depth		8528 -	8529 -	8530 -	

Accessories for drawers

 <p><b>CD holder for drawers</b> Please state exactly in your order and drawing in which 2 Raster drawer the CD holder is to be fitted.</p>		for 35.2 cm width	for 52.8 cm width	for 70.4 cm width	for 105.6 cm width
	for 33.0 cm depth	for 24 CD's <b>8420</b> -	for 36 CD's <b>8421</b> -	for 48 CD's <b>8422</b> -	for 84 CD's <b>8423</b> -
	for 45.0 cm depth <b>for floor units</b>	for 32 CD's <b>8424</b> -	for 48 CD's <b>8425</b> -	for 64 CD's <b>8426</b> -	for 112 CD's <b>8427</b> -
	for 45.0 cm depth <b>for wall/stacked units</b>	for 32 CD's <b>9424</b> -	for 48 CD's <b>9425</b> -	for 64 CD's <b>9426</b> -	for 112 CD's <b>9427</b> -
	for 52.0 cm depth	for 40 CD's <b>8428</b> -	for 60 CD's <b>8429</b> -	for 80 CD's <b>8430</b> -	for 140 CD's <b>8431</b> -
 <p><b>DVD holder for drawers</b> Please state exactly in your order and drawing in which 2 Raster drawer the DVD holder is to be fitted.</p>	for 33.0 cm depth	for 8 DVD's <b>8320</b> -	for 16 DVD's <b>8321</b> -	for 24 DVD's <b>8322</b> -	for 32 DVD's <b>8323</b> -
	for 45.0 cm depth <b>for floor units</b>	for 11 DVD's <b>8324</b> -	for 12 DVD's <b>8325</b> -	for 33 DVD's <b>8326</b> -	for 44 DVD's <b>8327</b> -
	for 45.0 cm depth <b>for wall/stacked units</b>	for 11 DVD's <b>9324</b> -	for 12 DVD's <b>9325</b> -	for 33 DVD's <b>9326</b> -	for 44 DVD's <b>9327</b> -
	for 52.0 cm depth	for 14 DVD's <b>8328</b> -	for 28 DVD's <b>8329</b> -	for 42 DVD's <b>8330</b> -	for 56 DVD's <b>8331</b> -
  <p><b>Cutlery box</b> of metal, lined with grey fabric inside; incl. compartments</p>		17.6 cm wide		35.2 cm wide	
	for 45.0 cm depth <b>for floor units</b>	<b>845</b> -	<b>846</b> -		
	for 45.0 cm depth <b>for wall/stacked units</b>	<b>945</b> -	<b>946</b> -		
	for 52.0 cm depth	<b>855</b> -	<b>856</b> -		
 <p><b>Cutlery holder</b> lined with grey fabric, for fitting in drawers</p> <p>Set 1: for 60 pieces of cutlery Set 2: for 17 serving utensils</p>		<b>Set 1:</b> for standard cutlery like spoons, forks, knives, etc.		<b>Set 2:</b> for sauce ladles, cake forks, cake servers, etc.	
		<b>116</b> -	<b>117</b> -		







# Accessories

## Metal substructure

### Metal substructure

12.8 cm high; for 42.3 cm and 49.3 cm depth;  
High-gloss chrome

Units, lowboards, side-/highboards and carcass units can be fitted optionally on a metal substructure. In this case the plinth adjusters are omitted.

											
for 105.6 cm width		for 140.8 cm width		for 158.4 cm width		for 176.0 cm width		for 211.2 cm width		for 246.4 cm width	
for 42.3 cm depth	for 49.3 cm depth	for 42.3 cm depth	for 49.3 cm depth	for 42.3 cm depth	for 49.3 cm depth	for 42.3 cm depth	for 49.3 cm depth	for 42.3 cm depth	for 49.3 cm depth	for 42.3 cm depth	for 49.3 cm depth
<b>4012</b>	<b>5012</b>	<b>4412</b>	<b>5412</b>	<b>4512</b>	<b>5512</b>	<b>4712</b>	<b>5712</b>	<b>4112</b>	<b>5112</b>	<b>4612</b>	<b>5612</b>
-	-	-	-	-	-	-	-	-	-	-	-

## Cover shelves

### Cover shelf

2.9 cm thick; 33.0 cm, 45.0 cm or 52.0 cm deep, or 47.9 or 54.9 cm deep for room dividers

All (carcase) units, low-, side- and highboards can be fitted with an extra cover shelf. We recommend fitting an extra cover shelf for visual reasons, if the (carcase) units, low-, side- and highboards are fitted between side-panels/converted with side-panels.

The cover shelf is charged in 10 cm lengths or parts thereof. To make things easier, only the total width of the combination needs to be calculated here. The cover shelves are full-length up to a max. 299.2 cm width.

Cover shelves are not available in high-gloss lacquer! In this case we recommend cover shelves of rear-lacquered glass (see below).

Price per 10 cm section:

	33.0 cm deep	45.0 cm deep	52.0 cm deep	47.9 cm deep (for room dividers)	54.9 cm deep (for room dividers)
<b>Price gr.</b>	<b>3515</b>	<b>3510</b>	<b>3517</b>	<b>3610</b>	<b>3617</b>
I	-	-	-	-	-
II	-	-	-	-	-

**Cover shelves of rear-lacquered glass**, optionally rear-lacquered in white, grey or silk grey  
0.8 cm thick; 45.0 cm or 52.0 cm deep, or 47.9 or 54.9 cm deep for room dividers

All (carcase) units, low-, side- and highboards can be fitted with an extra cover shelf.

The cover shelf is charged in 10 cm lengths or parts thereof. To make things easier, only the total width of the combination needs to be calculated here. The cover shelves are full-length up to a max. 299.2 cm width.

**Please be sure to state the required version in the order!**



Price per 10 cm section:

	33.0 cm deep	45.0 cm deep	52.0 cm deep	47.9 cm deep (for room dividers)	54.9 cm deep (for room dividers)
	X	<b>3530</b>	<b>3537</b>	<b>3630</b>	<b>3637</b>
	-	-	-	-	-

## Corner units

### Corner shelf incl. vertical cover panel

If NEO combinations are planned round corners with units (carcase units, single units, low-, side- or highboards), it is possible to include corner shelves incl. vertical cover panel. Only units of the same height can be planned round corners.

		<b>NEW</b>							
		for 2 Raster height (35.2 cm high)	for 3 Raster height (52.8 cm high)	for 4 Raster height (70.4 cm high)	for 5 Raster height (88.0 cm high)	for 6 Raster height (105.6 cm high)	for 8 Raster height (140.8 cm high)	for 10 Raster height (176.0 cm high)	for 12 Raster height (211.2 cm high)
	Corner shelf for floor units	<b>2004</b>	<b>3004</b>	<b>4004</b>	<b>5004</b>	<b>6004</b>	<b>8004</b>	<b>10004</b>	<b>12004</b>
	Price gr.	-	-	-	-	-	-	-	-
	I	-	-	-	-	-	-	-	-
	II	-	-	-	-	-	-	-	-
	Corner shelf for wall units	<b>2009</b>	<b>3009</b>	<b>4009</b>	<b>5009</b>	<b>6009</b>	<b>8009</b>	<b>10009</b>	<b>12009</b>
	Price gr.	-	-	-	-	-	-	-	-
	I	-	-	-	-	-	-	-	-
	II	-	-	-	-	-	-	-	-

**DINING**

hülsta offers a room concept to meet all requirements in comfort, beauty of form and attractiveness with a comprehensive collection of dining room tables and chairs.

The **dining tables** in a wide variety of sizes (with and without pullout function) in all wood surface versions and in contemporary designs, as well as the **dining chairs** that can be combined individually using different armrests, comfort features, high-grade cover fabrics (leather, textiles) and metal surfaces can all be found in the **“DINING”** type list.



**Coffee tables CT 90**

**Coffee tables CT 90**

The **CT 90 coffee table** is available in many different versions and in sizes of 80 x 80 cm and 110 x 110 cm. The top glass surface is rear-lacquered, the lower surface in matt lacquer. The CT 90 is also fitted with an optional veneered revolving drawer – optionally with LED lamp – in a number of different versions.

You will find the CT 90 coffee table as well as other coffee tables in the **“Coffee tables”** type list.





**Coffee tables**



**Coffee tables**

hülsta offers a comprehensive **collection of coffee tables**, which not only match the hülsta furniture ranges perfectly but can also be combined with other products that are available on the market. You will find these coffee tables in a number of designs, sizes and versions in the **“Coffee tables”** type list.

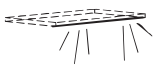
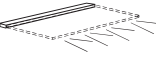
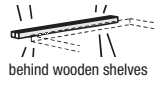
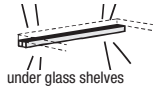

# Lamps

This luminaire contains built-in LED lamps of the energy classes A++ to A. The lamps cannot be changed in the luminaire. 12 V			LED lamps incl. footswitch. A Magic-Tronic or remote control unit is possible for operation (against a surcharge).								
			for 35.2 cm width	for 52.8 cm width	for 70.4 cm width	for 105.6 cm width	for 140.8 cm width	for 158.4 cm width	for 176.0 cm width	for 211.2 cm width	for 246.4 cm width
<b>LED light strip</b> 1.0 cm thick, 1.1 cm deep  	for fitting in (carcase) units		1.6 W	2.4 W	4.7 W	6.3 W		10.6 W			
			<b>322</b>	<b>522</b>	<b>822</b>	<b>112</b>		<b>NEW</b> <b>152</b>			
			-	-	-	-		-			
	for fitting in open compartments for carcase units		1.0 W	2.4 W	4.7 W	6.3 W					
			<b>352</b>	<b>522</b>	<b>722</b>	<b>112</b>					
			-	-	-	-					
	for fitting in lower cover shelves of wall units		1.6 W	2.4 W	4.7 W	6.3 W	10.2 W	10.6 W	2x 4.7 W	2x 6.3 W	2x 7.5 W
			<b>322</b>	<b>522</b>	<b>822</b>	<b>112</b>	<b>142</b>	<b>NEW</b> <b>152</b>	<b>172</b>	<b>212</b>	<b>242</b>
			-	-	-	-	-	-	-	-	-
<b>Glass rim lamp</b> 1.0 cm thick, 1.1 cm deep; LED light strip in aluminium profile, for fitting behind fitted glass shelves  Later fitting is not possible.  	for fitting in carcase units behind glass shelves		2.4 W	3.6 W	5.1 W						
			<b>321</b>	<b>521</b>	<b>821</b>						
			-	-	-						
	for fitting in open compartments behind glass shelves		2.0 W	3.2 W	4.7 W	7.5 W					
			<b>329</b>	<b>529</b>	<b>829</b>	<b>119</b>					
			-	-	-	-					
<b>LED light panel</b> 1.9 cm thick; 3.0 cm deep   	for fitting in carcase units behind fitted wooden shelves or under fitted glass shelves		2.4 W	3.6 W	5.1 W						
			<b>325</b>	<b>525</b>	<b>825</b>						
			-	-	-						
<b>Integrated power LED spotlamp</b> Ø 7.1 cm  	for fitting in (carcase) units, wall shelves, open compartments for carcase units, lower cover shelves of wall units		2.9 W								
			<b>7941</b>								
			-								

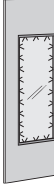
This luminaire contains built-in LED lamps of the energy classes A++ to A. The lamps cannot be changed in the luminaire. 12 V		LED lamps incl. footswitch. A Magic-Tronic or remote control unit is possible for operation (against a surcharge).			
		for 35.2 cm width	for 52.8 cm width	for 70.4 cm width	
<p><b>Aluminium frame lighting</b> LED lighting fitted behind the rim-side lacquering of the aluminium frame of the door/glass door.</p>	<p><b>NEW</b></p> 	for 4 Raster high glass door	8.2 W <b>4392</b>	10.1 W <b>4592</b>	11.6 W <b>4792</b>
		for 5 Raster high glass door	9.6 W <b>5392</b>	11.6 W <b>5592</b>	13.0 W <b>5792</b>
		for 6 Raster high glass door	11.6 W <b>6392</b>	13.5 W <b>6592</b>	14.9 W <b>6792</b>
		for 8 Raster high glass door	14.8 W <b>8392</b>	16.8 W <b>8592</b>	18.2 W <b>8792</b>
		for 10 Raster high glass door	18.3 W <b>10392</b>	20.2 W <b>10592</b>	21.6 W <b>10792</b>
		for 12 Raster high glass door	21.6 W <b>12392</b>	23.6 W <b>12592</b>	25.0 W <b>12792</b>
		for 6 Raster high door/glass door	4.8 W <b>6390</b>	6.8 W <b>6590</b>	8.2 W <b>6790</b>
		for 8 Raster high door/glass door	8.2 W <b>8390</b>	10.1 W <b>8590</b>	11.6 W <b>8790</b>
		for 10 Raster high door/glass door	11.6 W <b>10390</b>	13.5 W <b>10590</b>	14.9 W <b>10790</b>
		for 12 Raster high door/glass door	14.8 W <b>12390</b>	16.8 W <b>12590</b>	18.2 W <b>12790</b>
		for 6 Raster high door/glass door	<del>4.8 W</del>	4.8 W <b>6591</b>	6.8 W <b>6791</b>
		for 8 Raster high door/glass door	<del>8.2 W</del>	8.2 W <b>8591</b>	10.1 W <b>8791</b>
for 10 Raster high door/glass door		<del>11.6 W</del>	11.6 W <b>10591</b>	13.5 W <b>10791</b>	
for 12 Raster high door/glass door		<del>14.8 W</del>	14.8 W <b>12591</b>	16.8 W <b>12791</b>	

**Magic-Tronic**

The lamps are normally operated by an external footswitch. As an alternative we can also provide a Magic-Tronic switch, which is charged extra. By “stroking” the outer or top side of the unit at the same level as the invisible integrated sensor it is possible to switch all the lamps on and off (“Stroking method”). As an alternative the position of the hidden sensor can also be marked with a small metal plate on the furniture unit (“Marking method”). Lamps with a maximum power of 200 W can be operated by a Magic-Tronic unit (230 V). The footswitch is omitted when a Magic-Tronic unit is included.

Please be sure to observe the information and notes regarding the assembly position!

7617

**NEW**

**Remote control unit with changing colours**

The lamps are normally operated by an external footswitch. The colour temperature of the LED lamps is cold white if a footswitch is used. A 4-channel remote control unit, which is charged extra, is also available as an alternative. Several lamps (up to a total load of a maximum 30 W per transformer and receiver) can be operated with each of the 4 channels. All 4 channels can be dimmed separately at the push of a button. The colour temperature of all 4 channels can be set to any level from cold white (approx. 6500 kelvin = the basic setting of the LED lamps) to warm white (approx. 2700 kelvin). If warm white is required, a radio remote control unit must be ordered. It is also possible to switch all channels on and off simultaneously with the “all on” or “all off” buttons. Up to 4 transmitters can operate as many receivers as required. Transmitters and receivers must be ordered separately. The footswitch is omitted when the remote control unit is used.



Price per transmitter	Price per receiver
<b>2316</b>	<b>2317</b>
-	-







# Cable apertures

It is possible to provide the cover shelves, side sections, shelves, etc., in units from nearly all the hülsta living room ranges with cable apertures so it is easier to feed cables of electronic equipment through these units. There are four different types of cable apertures to choose from, as listed here. **Please be sure to follow the important notes.**

## Cable aperture K1

Cable aperture for 80 mm hole, silver colour  
**Standard cable aperture; particularly suitable for cover shelves, side sections and shelves**

**Sizes:**  
Assembly height: 21 mm  
Outside diameter: 92 mm  
Inside diameter: 74 mm  
Diameter of hole: 80 mm

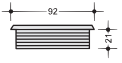

**K1**

## Cable aperture K2

Cable aperture for 80 mm hole, silver colour  
**particularly suitable for rear walls and side sections**

**Sizes:**  
Assembly height: 8 mm  
Outside diameter: 92 mm  
Inside diameter: 74 mm  
Diameter of hole: 80 mm

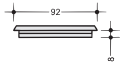

**K2**

## Cable aperture K3

Cable aperture for 60 mm hole, silver colour  
**particularly suitable for shelves and constructional shelves** (suitable to an extent for scart cables)

**Sizes:**  
Assembly height: 21 mm  
Outside diameter: 72 mm  
Inside diameter: 54 mm  
Diameter of hole: 60 mm

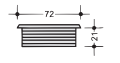

**K3**

## Cable aperture K20

Cable aperture for 80 mm hole, silver colour  
**particularly suitable for side-panels and centre partitions**

**Sizes:**  
Assembly height: 2x 8 mm  
Outside diameter: 92 mm  
Inside diameter: 74 mm  
Diameter of hole: 80 mm

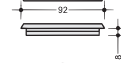

**K20**

### IMPORTANT NOTES Please be sure to note!

Please be sure to state the **exact position** of the cable aperture in your order (always measure distances from the centre of the cable aperture). For **wall units** the cable aperture is only possible in the bottom position (due to the suspension brackets). With **cover shelves**, the position of the cable aperture is determined in the factory, in accordance with factors specific to the given range. The same applies to technical exceptions because of custom-based planning. The K 20 is positioned in the centre (depthwise) in the **side-panel**. Please state the exact height (centre of hole of cable aperture from bottom rim of side-panel)! Subject to technical progress.

The **minimum distance** for the cable aperture (measured from the inside): 100 mm from the side and 70 mm from the rear (for horizontal surfaces) or 100 mm from the side and 70 mm from the base (for vertical surfaces). Please state if the aperture is to be fitted at the left, at the right or in the centre.

**Standard position:** If no details of the exact position of the cable aperture are given in your order, the cable aperture is always fitted at the bottom centre or at the rear centre of the relevant surface, whereby the distances stated above still apply.

**Caution!** Please note that the cable aperture can not be fitted where there is an integrated or front spotlight, centre partitions or a split rear wall. **Please be sure to observe the following explanatory diagrams!**

### for vertical surfaces

### for horizontal surfaces

#### Minimum distance

100 mm from the side and 70 mm from the base

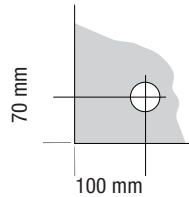
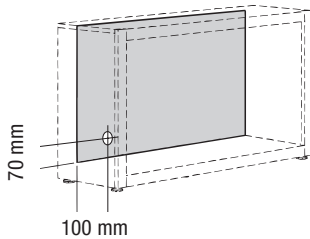

#### Minimum distance

100 mm from the side and 70 mm from the rear

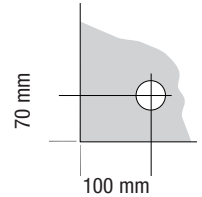
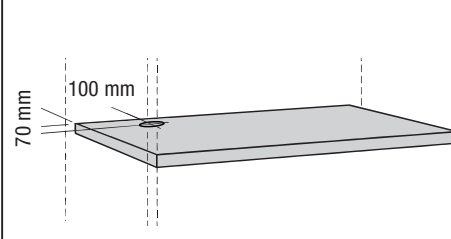

#### Standard position

at the centre of the surface and 70 mm from the base

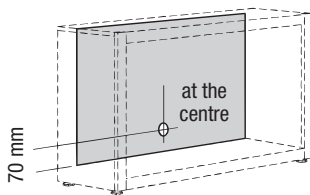

#### Standard position

at the centre of the surface and 70 mm from the rear

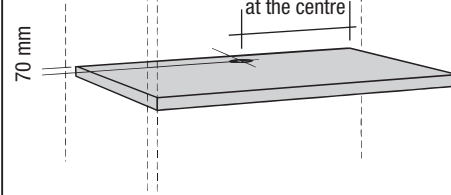

#### Please note!

If there is an integrated or front spotlight in a shelf, for example, the cable aperture cannot be fitted at this position!

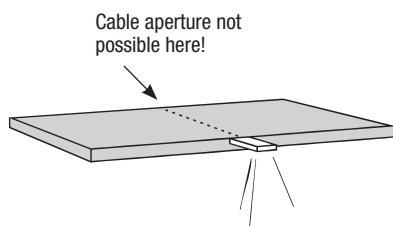

#### Please note!

If there is a centre partition, for example, between two shelves, the cable aperture cannot be fitted at this position!

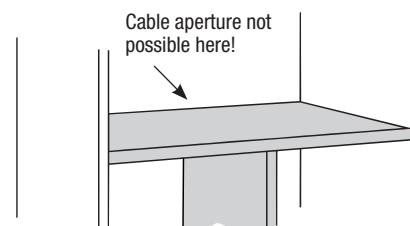

## Magic-Tronic

The lamps are normally operated by an external footswitch. As an alternative we can also provide a Magic-Tronic switch, which is charged extra. By “stroking” the outer or top side of the unit at the same level as the invisible integrated sensor it is possible to switch all the lamps on and off (“Stroking method”). As an alternative the position of the hidden sensor can also be marked with a small metal plate on the furniture unit (“Marking method”). Lamps with a maximum power of 200 W can be operated by a Magic-Tronic unit (230 V). The footswitch is omitted when a Magic-Tronic unit is included.

### Standard position of Magic-Tronic:

- for (assembly) units and wall units: **in the right outer side section**
- for side-panel combinations: **in the right outer side-panel**

### Standard depth position:

- for (assembly) units, wall units and side-panels: **approx. 12 cm from the rear rim**

### Standard height position:

- for all ranges (exception: SCOPIA range): for 1 to 8 Raster high floor (assembly) units and side-panels: **approx. 7-15 cm from the top rim of the appropriate unit**
- for the SCOPIA range: for 2 to 12 Raster high floor (assembly) units: **approx. 7-15 cm from the top rim of the appropriate unit**
- for all ranges (exception: SCOPIA range): for 10 to 12 Raster high floor (assembly) units and side-panels: **in approx. 115 cm height**
- for the SCOPIA range: for 16 to 18 Raster high floor (assembly) units: **in approx. 115 cm height**
- for wall units: **fitted at a height determined in the factory in accordance with factors specific to the given range.** The same applies to technical exceptions because of custom-based planning.
- for angled wooden shelves: fitted **in the right side of the rear wall panel in accordance with factors specific to the given range**

### Alternative positions:

If the Magic-Tronic sensor is to be fitted in the **left outer side section** of an (assembly) unit or wall unit, in the **left outer side-panel, in the left side of the rear wall panel of angled wooden shelves or at any position other than that stated as standard** (e.g., if a unit is planned in a niche so that there is insufficient space to the right of the unit), **please state this clearly in the order and mark the position in the sketch. If in doubt, please contact your hülsta customer advisor!**

### Please note:

- Double functions in one shelf like spotlamps, lamps, transformers, wall shelf brackets and Magic-Tronic units are not possible for reasons of stability and lack of space.
- In the case of NEO media panels, the unit is fitted 12 cm from the right side and from the bottom rim.

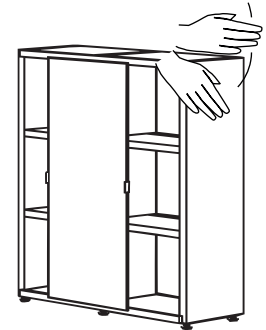

Illustration 1: “Stroking method“

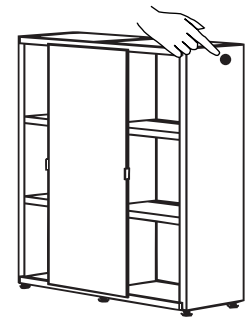

Illustration 2: “Marking method“

Magic-Tronic

7617

-

## Examples of use (schematic diagrams)

**Black point** = Standard position of Magic-Tronic sensor for floor (assembly) units, wall units and angled wooden shelves (example 1) or for side-panels (example 2)

### Notes:

The black point in the drawings is the area where the Magic-Tronic sensor is invisibly integrated. If the surface is „stroked“ at this position, the lamps are switched on or off.

If you would like to mark the position of the Magic-Tronic sensor on the furniture, you can fit a small metal plate supplied separately at the corresponding position.

In side-panels the Magic-Tronic unit can be operated from both sides of the side-panel, i.e. both from the outside as well as from the inside of the right side-panel - this means that the Magic-Tronic can even be operated when the furniture is fitted in a niche and there is insufficient space to the right of the unit. Please note here that no objects should be placed on the inside of the unit in order to be able to operate the Magic-Tronic from the inside.

Example 1

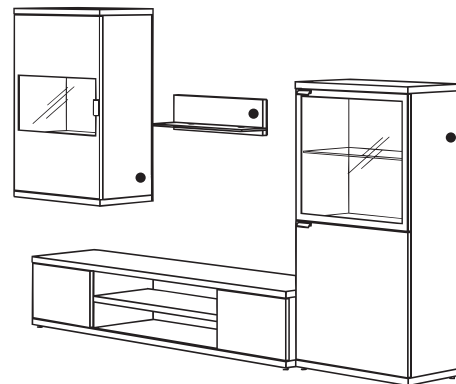

Example 2

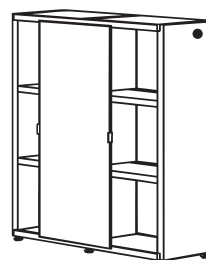

## Remote control unit with changing colours

The lamps are normally operated by an external footswitch. The colour temperature of the LED lamps is cold white if a footswitch is used. A 4-channel remote control unit, which is charged extra, is also available as an alternative. Several lamps (up to a total load of a maximum 30 W per transformer and receiver) can be operated with each of the 4 channels. All 4 channels can be dimmed separately at the push of a button. The colour temperature of all 4 channels can be set to any level from cold white (approx. 6500 kelvin = the basic setting of the LED lamps) to warm white (approx. 2700 kelvin). If warm white is required, a radio remote control unit must be ordered. It is also possible to switch all channels on and off simultaneously with the "all on" or "all off" buttons. Up to 4 transmitters can operate as many receivers as required. Transmitters and receivers must be ordered separately. The footswitch is omitted when the remote control unit is used.

**The following points must be noted with the radio remote control unit:**

- The receiver must be positioned behind a rear wall or under plinth shelves (at least 20 mm space required under plinth shelves).
- The total wattage power of all lamps included per power supply unit/receiver must not exceed 30 W.
- 4 channels = 4 light groups
- 1 light group = x lights
- All lamps within a light group can be dimmed to the same brightness.
- The same light colour can be set for all lamps in all the light groups. This light colour is then valid for all the lamps.
- The remote control unit is not suitable for equipment operating on 110 V.

**Important notes:**

The information on basic settings for the LED lamps as well as setting the colour temperature do not apply to the MULTI-VARIS range!  
Please be sure to note the operating and programming instructions!

**4-channel remote control unit with changing colours**

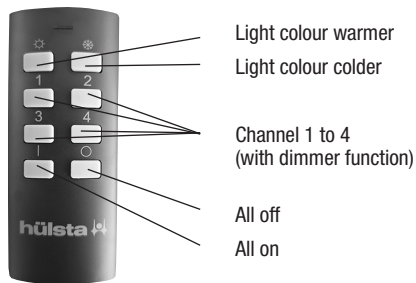

**4-channel remote control unit with changing colours**

Price per transmitter	type	2316	-
Price per receiver	type	2317	-

## Examples of use (schematic diagrams)

### Example 1

#### Lights inside a unit

Channel 1 operates (and dims) all the lights in light group 1, i.e. the LED spotlamp in the left cabinet

Channel 2 operates (and dims) all the lights in light group 2, i.e. the LED spotlamps in the open compartment

Channel 3 operates (and dims) all the lights in light group 3, i.e. the LED spotlamp in the right cabinet

Required are:

<b>1 transmitter</b>	1x type	<b>2316</b>	-
<b>1 receiver</b>	1x type	<b>2317</b>	-

Notes:

The total wattage power of all lamps included per power supply unit/receiver must not exceed 30 W. The same light colour can be set for all lamps in all the light groups. This light colour is then valid for all the lamps.

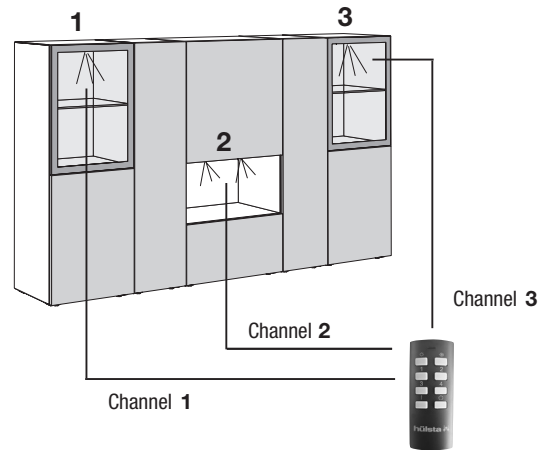

### Example 2

#### Lights in units set apart

Channel 1 operates (and dims) all the lights in light group 1, i.e. the LED spotlamp and the LED light panels in the left cabinet

Channel 2 operates (and dims) all the lights in light group 2, i.e. the LED spotlamps and the LED light panels in the centre cabinet

Channel 3 operates (and dims) all the lights in light group 3, i.e. the LED spotlamp and the LED light panels in the right cabinet

Required are:

<b>1 transmitter</b>	1x type	<b>2316</b>	-
<b>3 receivers</b>	3x type	<b>2317</b>	3x -

Notes:

The total wattage power of all lamps included per power supply unit/receiver must not exceed 30 W. The same light colour can be set for all lamps in all the light groups. This light colour is then valid for all the lamps.

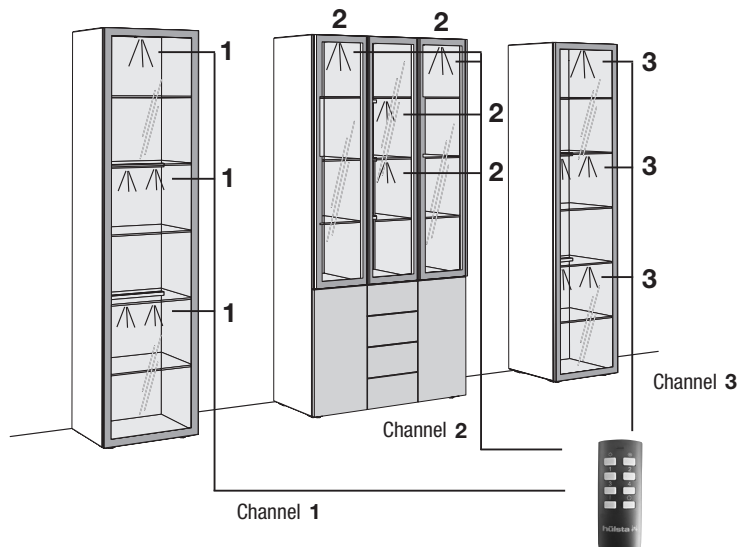

### Example 3

#### Lights in units set apart

Channel 1 operates (and dims) all the lights in light group 1, i.e. the LED spotlamps in the left, centre and right cabinet

Channel 2 operates (and dims) all the lights in light group 2, i.e. the top LED light panels in the left, centre and right cabinet

Channel 3 operates (and dims) all the lights in light group 3, i.e. the bottom LED light panels in the left, centre and right cabinet

Required are:

<b>1 transmitter</b>	1x type	<b>2316</b>	-
<b>3 receivers</b>	3x type	<b>2317</b>	3x -

Notes:

The total wattage power of all lamps included per power supply unit/receiver must not exceed 30 W. The same light colour can be set for all lamps in all the light groups. This light colour is then valid for all the lamps.

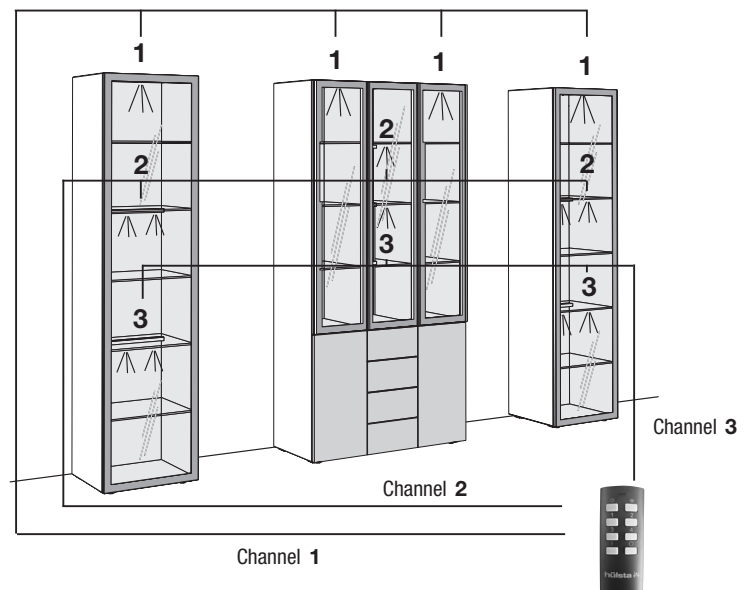

# Special-sized products

## NEO

<b>Height reductions:</b>		
Side-panel below 12 Raster (under 215.9 cm)	<b>99901</b>	-
<b>Width reductions:</b>		
Fitted wooden shelf	<b>99914</b>	-
Fitted glass shelf	<b>999143</b>	-
Wall shelf without lamp (not under 36 cm)	<b>99915</b>	-
<b>Depth reductions:</b>		
Carcase (not under 36.2 cm)	<b>99932</b>	-
Fitted wooden shelf	<b>999341</b>	-
Fitted glass shelf	<b>999344</b>	-
Fitted wooden shelf	<b>99934</b>	-
Fitted glass shelf	<b>999343</b>	-
Side-panel	<b>99931</b>	-
Wooden cover shelf	<b>99939</b>	-
Glass cover shelf	<b>999394</b>	-

Special products are not possible for: media panels, media panel shelves, carcase fronts, carcases including drawers with a hülsta-Push-to-open device, open compartments for carcase units, metal substructures, room dividers and coffee tables.

**More special products are possible.  
Please get in touch with your customer advisor.**

## Special articles

<b>Cover panels</b>			
for side and top panelling of fitted wardrobes (support construction and fitting materials must be acquired on site).			
Basic price per order		<b>9901</b>	-
+ price per m <sup>2</sup> lacquer or veneer		<b>990</b>	-
Veneer match with fronts can not be guaranteed.			
<b>Rim veneer</b>			
superimposed ex works or rims lacquered for veneer and lacquer versions per m. length			
		<b>9902</b>	-
<b>Dimensions</b>			
Range	max. length	max. width	
NEO	205.0 cm	40.0 cm	
<b>High-gloss care set</b>			
Polish, polishing sponge and polishing cloth (incl. instructions) for protecting and maintaining the high-gloss surfaces			
		<b>36</b>	-

### Individual special-sized products

If the special-sized product that you require is so unusual that it cannot be illustrated with the many special sized products that we already provide and charge for, then we will quote you the price using a HK unit type factor. In your order please state for us the relevant enquiry number and the HK unit type factor stated.

**HK** -

### Special colours; Note on „Blue Angel“ / Emissions label of DGM

#### Special colours

All the hülsta lacquer colours are possible for nearly all the hülsta ranges. Availability and prices on request.

#### Note on „Blue Angel“ (RAL-UZ 38) and Emissions label of DGM (Class A)

It is possible that the requirements of the „Blue Angel“ and the DGM Emissions Label cannot be met by some of the lacquer colours in price groups II and III (see here the different lacquer versions in the NURIA range), depending on the colour mix (surface ratio of these colours in the corresponding order). However, the legal requirements are definitely met in all cases!

## Wall composition / assembly instruction

**Important notes:**

The composition of walls must be ascertained before concluding a contract and be checked by a qualified fitter before assembly takes place.







Assembly may only be carried out by a qualified fitter under careful observation of the assembly instructions.

The plastic Rawl plugs with the type name SX 8 x 65 from the Fischer Company supplied by hülsta as a standard set are only suitable for concrete  $\geq$  C12/15, if the wall composition and compression strength corresponds to the table below. Under no circumstances must a unit be assembled on light masonry.

Furthermore, we provide a mounting set with assembly mortar from the Fischer Company for the types of walls listed below (see assembly mortar set below). Again, assembly must be carried out by a qualified fitter under careful observation of the wall composition and assembly instruction. The compression strength levels stated below must be met under all circumstances.

**Materials table**

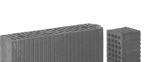
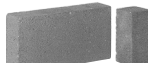
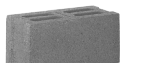
with a description of which sets are to be used with the following types of walls:

Standard set (SX 8 x 65)	Assembly mortar set only suitable for the materials stated below!	
Concrete C12/15 Compression strength $\geq$ 15 N/mm <sup>2</sup> 	 Building bricks Mz 12 Compression strength $\geq$ 12 N/mm <sup>2</sup>   Limestone blocks KS 12 Compression strength $\geq$ 12 N/mm <sup>2</sup>   Perforated sand lime bricks KSL12 Compression strength $\geq$ 12 N/mm <sup>2</sup>   Vertically perforated bricks HLZ 12 Compression strength $\geq$ 12 N/mm <sup>2</sup> Bulk density $\geq$ 1.0 kg/dm <sup>3</sup>	 Solid blocks of light concrete V2 Compression strength $\geq$ 2 N/mm <sup>2</sup>   Perforated blocks of light concrete Hbl 2 Compression strength $\geq$ 2 N/mm <sup>2</sup>   Aerated concrete PP2 Compression strength $\geq$ 2 N/mm <sup>2</sup>

A different and more suitable type of mounting must be chosen by a qualified fitter in all other cases. hülsta cannot accept any responsibility for the choice of any other types of mounting! Please note that if the units are not mounted properly on the wall, there is a risk of the units falling down or tipping over – especially when alternative mounting materials acquired on site have been used. Generally speaking, you as a dealer/qualified fitter are responsible for the correct wall mounting of the units.



## Mounting sets

**Labelling in type list drawings / assembly notes for wall units**

The majority of units have two wall mounting points (= number of support boards), if these are to be fitted as wall units. This is not explicitly mentioned in the type list. If a different number of wall mounting points (= support boards) is required, this is marked in the drawings in the type list with numbers in black boxes. Every support board requires four mounting screws.

- 3 = 3 support boards
- 4 = 4 support boards, etc.

One **assembly mortar set** is sufficient for up to a maximum of 3 support boards or 4 wall side-panels.

**Important note:** Depending on the composition of the wall (see wall types illustrated above), assembly must be carried out using the special assembly mortar set and a standard trade mastic tool which are the basic essentials for safe and clean workmanship.

**Standard set**

The standard set consists of 4 plastic Rawl plugs (SX 8 x 65) and 4 mounting screws and is sufficient for 1 support board. The standard sets are included in the packet of fittings to match the number of support boards.

**Assembly mortar set for up to a maximum of 3 support boards consisting of:**

- 9x injection retaining sleeve
- 9x screw-in sleeve
- 1x injection cartridge
- 2x static mixer
- 1x assembly instructions

Please use the mounting screws from the standard set (supplied free of charge).

**Example of order:**

- Add up number of support boards for all existing unit types
  - Divide the sum by “3”
  - Round up the result to a full number
- = Number of assembly mortar sets required

M2

-

## Your Hotline to hülsta

Do you have any questions or require any alterations to your order confirmation?  
Do you have any questions on our products or your current order?  
Do you have any complaints about supplied goods or required replacement parts?  
Contact Telephone: +49 (0) 2563 / 86-1144 • email: orders@huelsta.com

Do you have any questions, suggestions or wishes for the **hülsta Marketing team**  
or the **hülsta product seminars**?  
Contact Telephone: +49 (0) 2563 / 86-1611 • email: marketing@huelsta.com

## hülsta Planning Service

Lots to do? A customer wants his project finished and you haven't got enough time? Or the project is so complex that it will take too much time?

This is exactly the kind of situation we created the hülsta Planning Service for. hülsta's employees create the required project for you at short notice. Based on your information, we implement the project perfectly with all views and a complete order list ready for immediate forwarding to the customer.

The hülsta check list (available at <https://hulsta.com/de/service/showroom/>) makes it all really easy for you. You won't forget anything with this list and the customer receives a project he will be thrilled about as quickly as possible.

### hülsta Planning Service

Tel.: +49 (0) 2563 / 86-0

Fax: +49 (0) 2563 / 86-2666

Mail: Planungsservice-Handel@huelsta.de

Workdays from 8.00 a.m. until 6.00 p.m.

## Special wishes? Come to us!

**Maximum individuality! – Maximal flexibility! – hülsta makes most of your special wishes possible.**

And if you do have a wish which is not quite so easy to implement, just give us a call or send us a mail or a fax. We have our own hülsta "Special Wishes Team" who are there to help you realise just these customer requests. These colleagues are professionals when it comes to special products. They plan and calculate the products possible for you and even develop an alternative suggestion if the idea should turn out to be technically impossible.

**Here is an overview of the hülsta range of special wishes:**

- A lot of special products can be ordered simply via the type list
- Special-sized products are planned simply and professionally
- Competent colleagues advise you by phone, by fax and by mail
- You will be sent alternative suggestions if the idea is technically impossible
- Many special-sized products are available without a surcharge
- Specially qualified carpenters and technicians implement your plans perfectly

### hülsta Special Wishes Team

Tel.: +49 (0) 2563 / 86-0

Fax: +49 (0) 2563 / 86-1417

Mail: Sonderwunsch@huelsta.com

## We are open Saturdays for you, too!

Our **Saturday hotline** is available all day from **10.00 a.m. until 6.00 p.m.**

Telephone: +49 (0) 2563 / 86-1800

On **working days** the hülsta Sales Department is available all day from **8.00 a.m. until 6.00 p.m.**

## hülsta NEO

Stand: E 5.2018

Design and concept legally protected, subject to error and alterations to construction, colour and materials by way of technological progress.

hülsta-werke · Karl-Hüls-Straße 1 · D-48703 Stadtlohn  
Tel. +49 (0) 2563 / 86-0 · Fax +49 (0) 2563 / 86-1000  
[www.huelsta.com](http://www.huelsta.com)

**hülsta**   
**Die Möbelmarke.**