

PRODUCT INFORMATION MODEL OD0319 TAO

© 2019 KURT BEIER & KATI QUINGER



Focus Open 2020
Special Mention



360° rotational function



Practical stools or armrest cushions





Functional back cushions
ensure individual sitting comfort

OD TAO: PURISTIC OUTDOOR ENSEMBLE, INDIVIDUALLY CONFIGURABLE. UPHOLSTERY WITH SWIVEL AND SLIDING FUNCTION ON A HIGH-QUALITY SOLID WOODEN PLATEAU. UNIQUE DESIGN WITH ADJUSTABLE AND MOVABLE FUNCTIONAL BACKS THAT CAN BE PLACED VARIABLY ON THE SEAT CUSHION. SELECTABLE OUTDOOR COVERS (FABRIC AND LEATHER) AND SEAM TYPES.



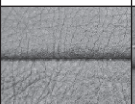
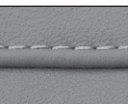

Feet: angular steel, powder-coated fine structure in black matt
Height: 10 cm / **Floor distance:** approx. 10 cm

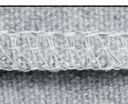
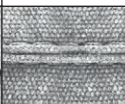
Corpus (elements) rocessing options of main seam / decorative seam

	Plain seam	Lap seam	KR* (zipper piping) extra charge	Overcast seam extra charge	Piping
					
Outdoor fabric	x		x	x	x
Outdoor leather	x		x		

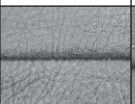
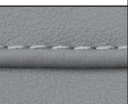
Backs ,processing options of main seam / decorative seam

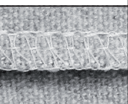
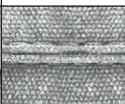
	Plain seam	Lap seam	KR* (zipper piping) extra charge	Overcast seam extra charge	Piping
					
Outdoor fabric	x			x	
Outdoor leather	x				

*Zipper piping: optionally in the colours black, red, nature or light grey.

Outdoor innercover

Additional protection against moisture penetration is provided by an inner cover made of waterproof fabric. The inner cover can be selected for the respective model at an extra charge. Please specify when ordering.

Outdoor wood, standard surfaces:

	Spruce black	Larch	Thermo ash	Beam oak
	(dark puttied)	(brown puttied)	(brown puttied)	(not puttied)
	OPG1	OPG1	OPG2	OPG2
				

Untreated	⊘	*	⊘	⊘
Oiled	⊘	✓	✓	⊘
Lacquered	⊘	*	*	✓
Glazed	✓	⊘	⊘	⊘

Puttied areas may have a different colour appearance depending on the surface. For example, dark putty can look lighter on untreated wood.

- * = Available on request against processing surcharge
- ✓ = Bullfrog recommendation and standard surface
- ⊘ = These variants are not available



Angular steel feet, powder-coated fine structure in black matt

Model OD0319 Tao is also available as indoor product!
For further informations refer to product information 0319 Tao.

04.4.2023

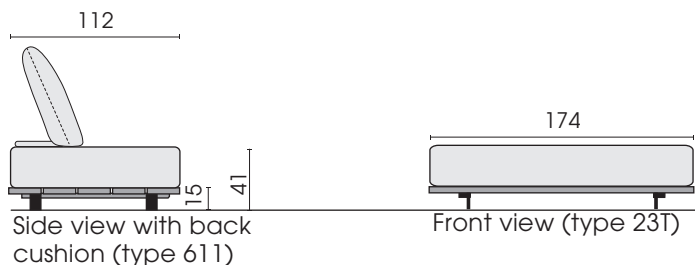

Fixed seat elements:

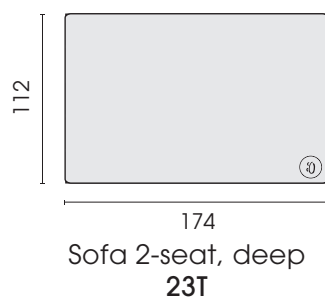

Possible combinations with 2 fixed seat elements:

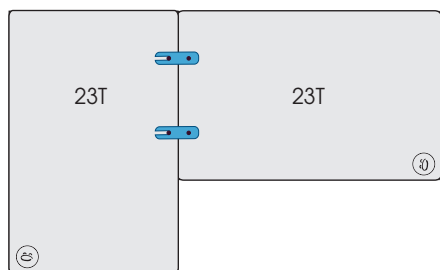

Corner combination, left
2 x 23T

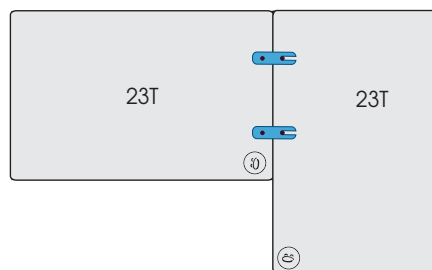

Corner combination, right
2 x 23T

 = Connection point

Each piece of furniture is handmade and unique. Deviations to the listed measurements may be caused by:
1. different upholstery materials (fabric, leather), 2. processing of ticking mats, 3. the pressure to combine individual parts, etc.
The seat comfort of a sofa type with larger seat depth usually differs from one with lower depth.



Combination with 360° rotational function

2 x 23TF

3 x Functional back 609

Stool/armrest 540

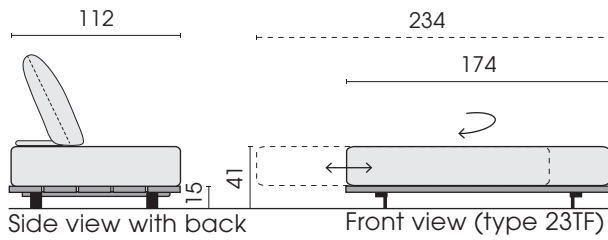

Side view with back cushion (type 611)

Front view (type 23TF)

• = Pivot

Seat element with 360° turn and sliding function:

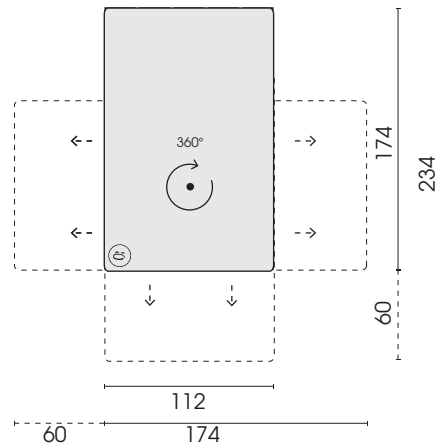

Sofa 2-seat, deep, 360° turn function and sliding function
23TF

Attention! Element 23TF can be used for both sides (left element/right element).
The pivot signs the direction left/right! ⤻ The side of the pivot is marked at plateau! ☹

Attention! If a functional element 23TF stands separately or isn't connected with another element, it can tip-over if it is not in a centre position as shown beside. Therefore always shift the upholstery back to the centre position!

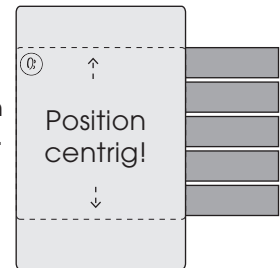

To avoid tip-over with a single element, push upholstery centric

Optionally back-/armrest bracket at type 23TF:

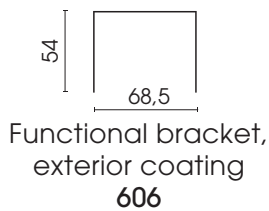

Attention! Consistent with functional bracket: back-/floor cushion **585**

Max. height of back with bracket:
With cushion: approx. 93 cm/
bracket: approx. 66 cm

Use of functional bracket:

Attention! Bracket extends laterally by approx. 1,5 cm.

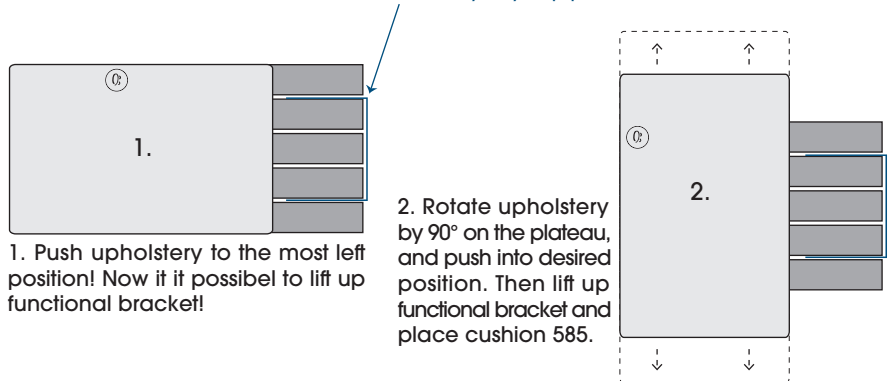

1. Push upholstery to the most left position! Now it is possible to lift up functional bracket!

2. Rotate upholstery by 90° on the plateau, and push into desired position. Then lift up functional bracket and place cushion 585.

Each piece of furniture is handmade and unique. Deviations to the listed measurements may be caused by:

1. different upholstery materials (fabric, leather),
 2. processing of ticking mats,
 3. the pressure to combine individual parts, etc.
- The seat comfort of a sofa type with larger seat depth usually differs from one with lower depth.

Combinations with 2 x 23TF (example pictures: indoor leather combination):

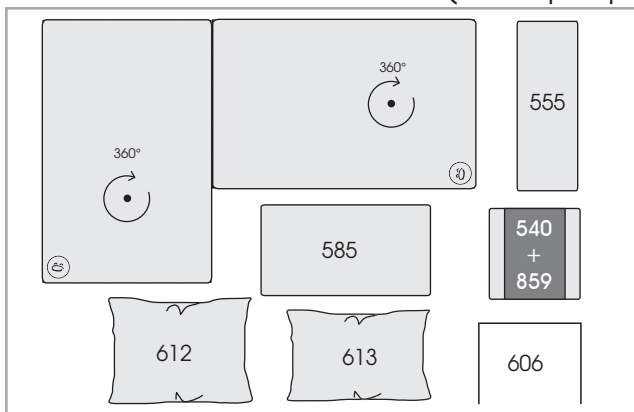

Each piece of furniture is handmade and unique. Deviations to the listed measurements may be caused by:
 1. different upholstery materials (fabric, leather), 2. processing of ticking mats, 3. the pressure to combine individual parts, etc.
 The seat comfort of a sofa type with larger seat depth usually differs from one with lower depth.





Each piece of furniture is handmade and unique. Deviations to the listed measurements may be caused by:
 1. different upholstery materials (fabric, leather), 2. processing of ticking mats, 3. the pressure to combine individual parts, etc.
 The seat comfort of a sofa type with larger seat depth usually differs from one with lower depth.

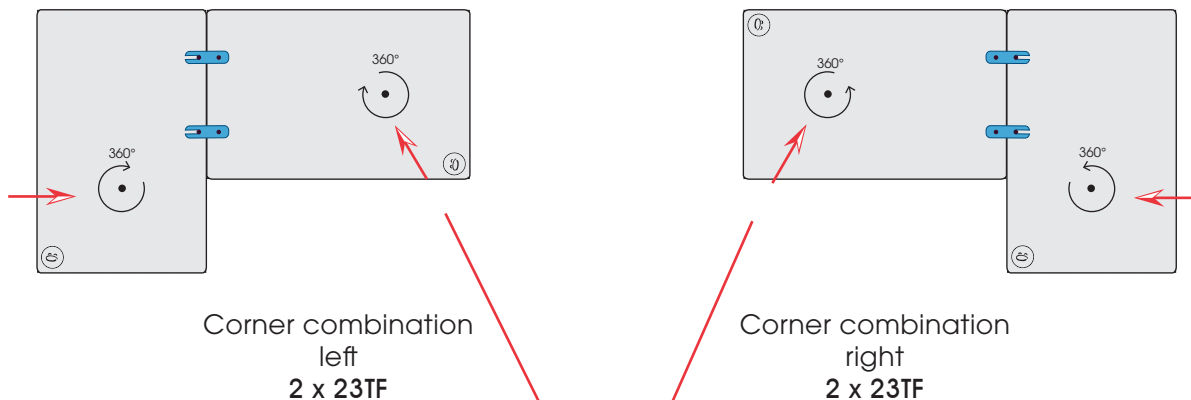

Each piece of furniture is handmade and unique. Deviations to the listed measurements may be caused by:
 1. different upholstery materials (fabric, leather), 2. processing of ticking mats, 3. the pressure to combine individual parts, etc.
 The seat comfort of a sofa type with larger seat depth usually differs from one with lower depth.

Possible combinations, consisting of 2 x 23TF:



Attention! When setting up the elements, pay attention to the pivot! 
The side of the pivot is marked at plateau! 



Corner combination
left
2 x 23TF
Stool/armrest 540

 = Connection point

Each piece of furniture is handmade and unique. Deviations to the listed measurements may be caused by:
1. different upholstery materials (fabric, leather), 2. processing of ticking mats, 3. the pressure to combine individual parts, etc.
The seat comfort of a sofa type with larger seat depth usually differs from one with lower depth.

Further combinations, consisting of 2 x 23TF:

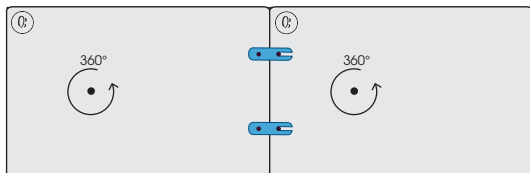

Sofa, wide,
left
2 x 23TF

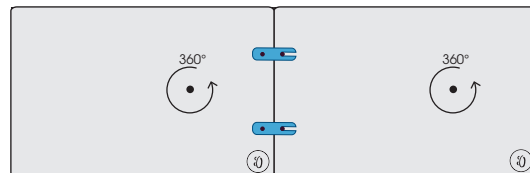

Sofa, wide,
right
2 x 23TF

Attention! The pivot signs the direction left/right!



The side of the pivot is marked at plateau!



Combinations with 2 x 23TF (example pictures: indoor leather combination):



Sofa, wide
left
2 x 23TF



 = Connection point

Each piece of furniture is handmade and unique. Deviations to the listed measurements may be caused by:
1. different upholstery materials (fabric, leather), 2. processing of ticking mats, 3. the pressure to combine individual parts, etc.
The seat comfort of a sofa type with larger seat depth usually differs from one with lower depth.

Stool / floor cushion:

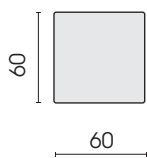

Stool / armrest removable
H = 39 cm
540



Stool / armrest removable
H = 39 cm
555

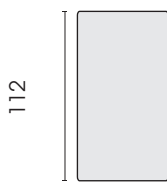

Stool / armrest removable
H = 39 cm
590



Floor-/back cushion
H: 26 cm
585

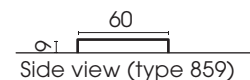

Side view (type 859)



Table to apply on stool, metal
Stool / armrest 540/585
matt black fine structure
powder-coated
corrosion protection
removable
859



Side view
(type 609/613)

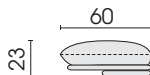

Side view,
folded down
(type 609/613)

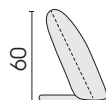

Side view
(type 611/612)

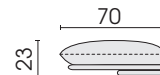

Side view,
folded down
(type 611/612)

Functional back, model OD1070:



Moba NB
Functional back
(tapered cushion)
80 x 60
609

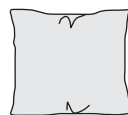

Moba B
Functional back
(tapered cushion)
80 x 70
611



Moba XB
Functional back
(tapered cushion)
95 x 70
612



Moba XN
Functional back
(tapered cushion)
95 x 60
613



Outdoor cushion
(tapered cushion)
(decorative overcast seam)
60 x 40
OD925



Outdoor cushion
(tapered cushion)
(plain seam)
60 x 40
OD967



Outdoor cushion
(tapered cushion)
KR (zipper piping)
60 x 40
OD967KR
Zipper piping:
optionally in the colours
black, red, nature
or light grey

Protective covers (waterproof):

Protective cover for type 23T/23TF: SH23T

Protective cover for type 540: SH540

Protective cover for type 555: SH555

Protective cover for type 590: SH590

Protective cover for type 585: SH585

Each piece of furniture is handmade and unique. Deviations to the listed measurements may be caused by:
1. different upholstery materials (fabric, leather), 2. processing of ticking mats, 3. the pressure to combine individual parts, etc.
The seat comfort of a sofa type with larger seat depth usually differs from one with lower depth.